

Operating instructions

Dishwasher



To avoid the risk of accidents or damage to the appliance, it is **essential** to read these instructions as well as the installation sheet before it is installed and used for the first time.

Warning and safety instructions	7
Guide to the appliance	16
Appliance overview	16
Control panel	17
Caring for the environment	20
Before using for the first time	21
Opening the door	21
Door-opening mechanism	22
Closing the door	22
Miele@home	23
Basic settings	24
Setting the language	24
Setting up Miele@home	24
Setting the time of day	25
Setting the water hardness level	25
Activating AutoDos	26
Dishwasher salt	27
Filling the salt reservoir	28
Replenishing salt	29
Rinse aid	30
Adding rinse aid	31
Filling the rinse aid reservoir	31
Caring for the environment	32
Economical dishwashing	32
EcoFeedback consumption indicator	33
EcoTech heat accumulator	34
Loading the dishwasher	35
General information	35
Upper basket	37
Adjust the upper basket	40
Lower basket	41
Cutlery tray	44
Loading the 3D MultiFlex tray	44
Loading examples	45
Dishwashers with cutlery tray	45
Detergent	47
Active ingredients	47
Detergent dosage	48

Contents

Automatic dispensing/AutoDos.....	49
Activating AutoDos.....	49
Inserting a PowerDisk.....	50
Manual detergent dispensing.....	52
Detergent dispensing	52
Adding detergent.....	52
Operation	54
Switching on the dishwasher	54
Selecting a programme	54
Display of programme duration	55
Starting the programme	55
End of programme.....	56
Energy management	56
Switching off the dishwasher	57
Unloading the dishwasher.....	57
Interrupting a programme.....	58
Cancelling or changing a programme	58
Options	59
Timer ☺	59
Activating Remote start 	63
Programme overview	64
Further programmes.....	68
Extras	69
Selecting extras.....	69
Cleaning and care	71
Cleaning the wash cabinet.....	71
Cleaning the door and the door seal.....	71
Cleaning the control panel	72
Cleaning the reflector panel	72
Cleaning the appliance front	72
Cleaning the AutoDos	73
Cleaning the spray arms.....	75
Checking the filters in the wash cabinet	77
Cleaning the filters.....	77
Cleaning the water inlet filter.....	79
Cleaning the drain pump.....	80
Problem solving guide	82
Technical problems	82

Fault messages	83
Door release	84
Water inlet fault	85
Water drainage fault	86
Fault in the AutoDos (automatic dispensing).....	87
Spray arm fault	89
General problems with the dishwasher	90
Noises.....	92
Unsatisfactory washing result	93
Service	96
Contact in case of malfunction	96
Warranty	96
Note for test institutes	96
Optional accessories	97
Installation	99
The Miele Waterproof system.....	99
Water inlet	99
Water drainage	101
Electrical connection.....	103
Technical data	104
Conformity declaration	105
Data sheet for household dishwashers	106
Settings	108
Opening the settings menu	108
Changing settings	108
Closing the settings menu.....	108
Language 	109
Time.....	109
Water hardness	110
AutoDos (automatic dispensing)	110
Rinse aid.....	111
Miele@home	111
Remote control.....	114
Remote Update	114
SmartStart	115
EcoStart.....	116
Consumption (EcoFeedback).....	118
Temperature	118
Display brightness.....	118

Contents

Volume.....	119
Refill reminders.....	119
AutoOpen	120
Knock2open	120
BrilliantLight.....	120
Hygiene cycle.....	120
Heat accumulator.....	121
Software version.....	121
Legal information.....	121
Showroom	121
Factory default.....	121

Warning and safety instructions

This dishwasher conforms to current safety requirements. Inappropriate use can, however, lead to personal injury and material damage.

Please observe the installation sheet and read the operating instructions carefully before setting up the dishwasher and using it for the first time. They both contain important information on its installation, safety, use and maintenance. This is to protect yourself from injury and prevent damage to the dishwasher.

In accordance with standard IEC 60335-1, Miele expressly and strongly advises that you read and follow the instructions in the chapter on installing the dishwasher as well as the safety instructions and warnings.

Miele cannot be held liable for damage caused by non-compliance with these instructions.

Keep the installation sheet and the operating instructions in a safe place and pass them on to any future owner.

Warning and safety instructions

Appropriate use

- ▶ This dishwasher is intended for use in domestic households and similar working and residential environments.
- ▶ This dishwasher is not intended for outdoor use.
- ▶ This dishwasher is intended for use at altitudes of up to 4000 m above sea level.
- ▶ This dishwasher must only be used for cleaning domestic crockery and cutlery. All other types of use are not permitted.
- ▶ The appliance can only be used by people with reduced physical, sensory or mental capabilities, or lack of experience and knowledge, if they are supervised whilst using it, or have been shown how to use it in a safe way and recognise and understand the consequences of incorrect operation.

Safety with children

- ▶ Children under 8 years of age must be kept away from the dishwasher unless they are constantly supervised.
- ▶ Children aged 8 and older may only use the dishwasher without supervision if they have been shown how to use it in a safe manner. Children must be able to understand and recognise the possible dangers caused by incorrect operation.
- ▶ Children must not be allowed to clean or maintain the dishwasher unsupervised.
- ▶ Children should be supervised in the vicinity of the dishwasher. Never allow children to play with the dishwasher. There is a danger that children might shut themselves in the dishwasher.
- ▶ If the automatic door opening mechanism is active (depending on the model), keep young children away from the area in which the door opens. There is a danger of injury in the unlikely event of a fault with the opening mechanism.
- ▶ Danger of suffocation! Whilst playing, children may become entangled in packaging material (such as plastic wrapping) or pull it over their head and risk suffocation. Keep packaging material away from children.
- ▶ Keep children away from detergents. Detergents cause severe skin burns and severe eye damage. They can cause burning in the mouth and throat, or inhibit breathing. It is therefore important to keep children away from the dishwasher when the door is open. Detergent residues could still be present in the dishwasher. Seek medical advice immediately if a child has swallowed or inhaled any detergents.

Warning and safety instructions

Technical safety

- ▶ Unauthorised installation, maintenance and repairs can cause considerable danger for the user. Installation, maintenance and repairs must only be carried out by a qualified technician.
- ▶ Damage to the dishwasher can compromise your safety. Before using the dishwasher, check it for any visible damage. Never use a damaged dishwasher.
- ▶ The electrical safety of this dishwasher can only be guaranteed when correctly earthed. It is most important that this basic safety requirement is present. If in doubt, the electrical installation should be checked by a qualified electrician.
Miele cannot be held liable for the consequences of an inadequate or lack of earthing system (e.g. electric shock).
- ▶ Reliable and safe operation of this dishwasher can only be assured if it has been connected to the mains electricity supply.
- ▶ The dishwasher must only be plugged into the electricity supply via a suitable socket and plug (e.g. a switched socket and fused 3-pin plug in the UK). It must not be hard-wired. The electrical socket must be easily accessible after the dishwasher is installed so that it can be disconnected from the electricity supply at any time.
- ▶ There must be no electrical sockets behind the dishwasher because the building-in niche may be too small. Danger of overheating and fire risk if the dishwasher were to be pushed up against a plug.
- ▶ The dishwasher must not be installed underneath a hob. The high temperatures radiated by hobs could damage the dishwasher below. For the same reason, the appliance must not be installed next to open fires or other appliances that give off heat, such as heaters etc., not normally found in a kitchen.

Warning and safety instructions

- ▶ Ensure that the connection data on the dishwasher's data plate (fuse rating, frequency and voltage) match the mains electricity supply. This data must correspond in order to avoid the risk of damage to the dishwasher. Compare these before connecting the appliance to the mains. If in any doubt, consult a qualified electrician.
- ▶ Do not connect the dishwasher to the mains supply until it has been fully installed and any adjustment has been made to the door springs.
- ▶ The dishwasher may only be operated if the door opening mechanism is working correctly. Otherwise there could be a risk of danger whilst the automatic door opening mechanism (depending on the model) is active.
To check that the door opening mechanism is working correctly:
 - The door springs must be evenly adjusted on both sides. They are correctly adjusted when the door remains stationary when left half open (approx. 45° opening angle). It is also important that the door cannot fall open.
 - The door locking pins automatically retract when the door opens at the end of the drying phase.
- ▶ Multi-socket adapters and extension leads do not guarantee the required safety of the appliance (fire hazard). Do not connect the dishwasher to the mains electricity supply using a multi-socket adapter or an extension lead.
- ▶ The dishwasher must not be used in a non-stationary location (e.g. on a ship).
- ▶ Do not install the dishwasher in a room where there is a risk of frost occurring. Frozen hoses are at risk of tearing or bursting. The reliability of the electronic control unit may be impaired at temperatures below freezing point.
- ▶ To avoid any damage to the dishwasher, it must only be operated when it is connected to a fully vented plumbing system.

Warning and safety instructions

- ▶ The plastic housing of the water connection contains a solenoid valve. The housing must not be dipped in water.
- ▶ There are live wires in the water inlet hose. Do not cut the hose, even if it is too long.
- ▶ The integrated Waterproof system offers protection from water damage, provided that the following conditions are met:
 - Installation has been carried out correctly
 - The dishwasher is properly maintained and parts are replaced where this is noticeably required
 - The stopcock is turned off during longer absences from the home (e.g. whilst on holiday).

The Waterproof system will work even when the dishwasher is switched off. However, the dishwasher must remain connected to the electricity supply.

- ▶ The water-connection pressure needs to be between 50 and 1,000 kPa.
- ▶ A damaged dishwasher could be dangerous. If the dishwasher gets damaged, switch it off at the mains immediately and call your Miele dealer or Miele Service.
- ▶ While the appliance is under warranty, repairs should only be undertaken by a Miele authorised service technician. Otherwise the warranty is invalidated.
- ▶ Miele can only guarantee the safety of the appliance when genuine Miele original replacement parts are used. Faulty components must only be replaced by genuine Miele original spare parts.
- ▶ During installation, maintenance and repair work, the dishwasher must be disconnected from the mains electricity supply (switch it off and withdraw the plug from the socket).

Warning and safety instructions

- ▶ If the connection cable is damaged it must be replaced with a special cable of the same type (available from Miele). For safety reasons this work must be carried out by a Miele authorised service technician only.
- ▶ This dishwasher is supplied with a special lamp (depending on the model) to cope with particular conditions (e.g. in terms of temperature, moisture, chemical resistance, abrasion resistance and vibration). This special lamp must only be used for the purpose for which it is intended. It is not suitable for room lighting. Replacement lamps may only be fitted by a Miele authorised person or by Miele Service.

Correct installation

- ▶ The dishwasher must be installed and connected in compliance with the supplied installation sheet.



- ▶ Be careful before and while installing the dishwasher. Some metal parts pose a risk of injury/being cut. Wear protective gloves.

- ▶ The dishwasher must be correctly aligned horizontally to ensure problem-free operation.
- ▶ In order to ensure stability, built-under and integrated dishwashers must only be installed under a continuous worktop that is secured to adjacent cabinetry.
- ▶ The dishwasher must only be built into a tall unit if additional safety precautions are taken. In order to safely install the appliance in a tall unit, please use the Tall unit installation set and observe the installation sheet provided. Otherwise there is the danger of the unit tipping over.
- ▶ If you want to convert your freestanding dishwasher to a built-under model and you remove the existing plinth to do so, you must replace it with a U-model plinth. Please use the appropriate conversion kit to do this. This is necessary to avoid the risk of injury caused by protruding metal parts.

Warning and safety instructions

▶ The door springs must be evenly adjusted on both sides. They are correctly adjusted when the door remains stationary when left half open (approx. 45° opening angle). It is also important that the door cannot fall open.

The appliance must only be operated with properly adjusted door springs.

Correct use

▶ Do not use solvents in the dishwasher. Risk of explosion.

▶ Dishwasher detergents can cause burning on the skin and in the eyes, nose, mouth and throat. Avoid contact with detergents. Do not inhale powder detergents. Do not swallow dishwasher detergents. Seek medical attention immediately if detergent has been swallowed or inhaled.

▶ Avoid leaving the dishwasher door open unnecessarily. You could injure yourself on the open door or trip over it.

▶ Do not sit or lean on the open door. The dishwasher could tip over. This could injure you or damage the dishwasher.

▶ Crockery may be very hot at the end of the programme. Allow the dishes to cool until they are comfortable enough to handle before unloading them.

▶ Only use detergent and rinse aid formulated for domestic dishwashers. Do not use washing-up liquid.

▶ Do not use any commercial or industrial detergents. These may cause material damage, and there is a risk of a severe explosive chemical reaction (such as an explosive oxyhydrogen gas reaction).

▶ Do not fill the rinse aid reservoir with powder or liquid detergent. This will cause damage to the reservoir.

▶ Do not fill the AutoDos (depending on model) with powder or liquid detergent. Loose detergent will damage the AutoDos.

Warning and safety instructions

- ▶ Do not fill the salt reservoir with powder or liquid detergent. Detergent will damage the water softener.
- ▶ Only use special coarse-grained dishwasher salt or other pure kitchen salt for reactivation. Other salts may contain insoluble additives that can impair the functioning of the water softener.
- ▶ In dishwashers with a cutlery basket (depending on model), knives and forks should be placed with the handles upwards in the basket for safety reasons. Knives and forks placed with the handles downwards pose a danger of injury. However, cutlery placed handle down in the basket will come out cleaner and drier.
- ▶ Plastic items that cannot withstand being washed in hot water, such as disposable plastic containers or plastic cutlery, should not be cleaned in the dishwasher. The high temperatures in the dishwasher may cause them to melt or lose shape.
- ▶ If you use the timer option (depending on model), the detergent compartment must be dry. If it is not, wipe it until dry. The detergent will clump together if the detergent compartment is not dry, and this may mean that it is not fully rinsed out.
- ▶ Please observe the information given in the “Technical data” chapter regarding the capacity of the dishwasher.

Accessories

- ▶ Only use original Miele accessories. If other parts are used, any warranty, performance, and product liability claims will be invalidated.

Transport

- ▶ Only transport the dishwasher in an upright position so that no water flows into the electrical controls, as this would cause faults.
- ▶ If you wish to transport the dishwasher, empty it and securely fasten all loose parts such as baskets, hoses and cables.

Guide to the appliance



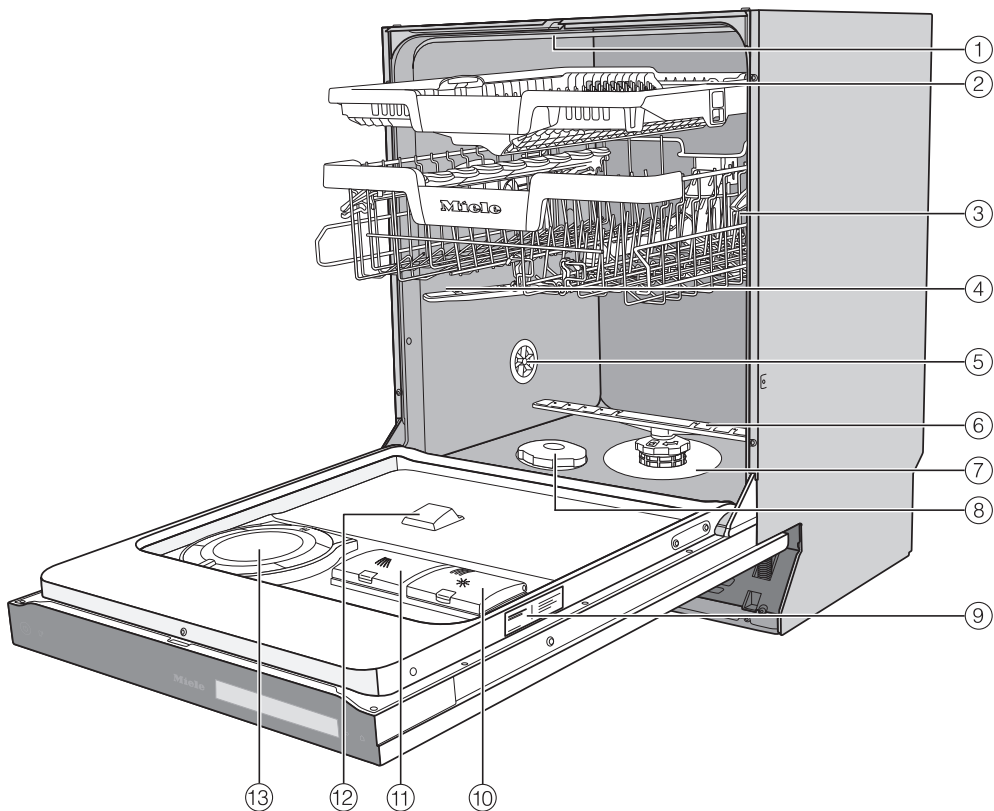

Appliance overview



- ① Top spray arm
- ② 3D MultiFlex tray (depending on model)
- ③ Upper basket (depending on model)
- ④ Middle spray arm
- ⑤ Aeration valve
- ⑥ Bottom spray arm
- ⑦ Filter combination
- ⑧ Salt reservoir
- ⑨ Data plate
- ⑩ Rinse aid reservoir
- ⑪ Detergent compartment
- ⑫ AutoDos detergent outlet
- ⑬ AutoDos (automatic dispensing)

Control panel



- ① Optical in-operation indicator light
For indicating an ongoing wash programme when the door is closed.
- ②  *On/Off* sensor control
For switching the dishwasher on and off.
- ③  *Remote start* sensor control
For activating/deactivating the Remote start option.
- ④ Touch display
For further information, see the “Display functions” section in the “Guide to the appliance” section.
- ⑤  *Back* sensor control
For navigating back to the previous menu or deleting values that have been set previously.
- ⑥  *Home* sensor control
For returning to the Programmes menu.

These operating instructions apply to several different dishwasher models of different heights.
The different dishwasher models will be named as follows:
normal = dishwasher measuring 80.5 cm high (built-in appliance)
or 84.5 cm high (freestanding appliance)
XXL = dishwasher measuring 84.5 cm high (built-in appliance).

Guide to the appliance

Display functions

The display is used to select or set the following:

- The programme
- Options
- The timer
- The Settings

The display can show the following:

- The programme name
- The programme stage
- The estimated time left for the programme to run
- The energy and water consumption (EcoFeedback)
- Any relevant fault messages and information

To save energy, the dishwasher switches off after a few minutes if you do not press any sensor controls during this time.
Touch the  sensor control to switch the dishwasher back on.

The sensor controls on the control panel and in the display react to fingertip contact.

The touch display can be scratched by pointed or sharp objects, e.g. pens.
Only touch the display with your fingers.

Touch the required menu option to select it.

The currently selected setting is marked in orange and can be changed.

The *OK* sensor control in the display is used to confirm a message or setting and to move to another menu level.

To exit a sub-menu again, use the  Back sensor control.

Touch the  sensor control at any time to return to the Programme menu.

If you do not press any sensor controls for several seconds, the display will revert to the previous menu. You will then have to enter your settings again.

Examples of how to operate the appliance

Main menu

Use the ↶ Back sensor control to switch from the Programme menu to the main menu.

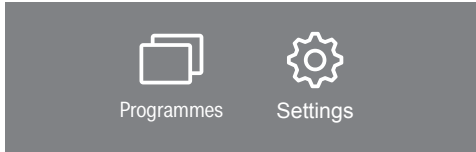

In the main menu, you can choose the Programme menu to select programmes as well as the Settings menu.

You can alter the dishwasher's controls to suit changing requirements in the Settings menu (see "Settings" chapter).

Option lists

You can scroll to the right or the left by swiping your finger across the display.

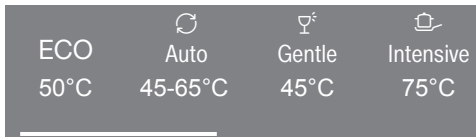

The orange bar at the bottom of the display indicates that further options are available.

You can change the order of programmes listed in the Programmes menu by pressing and holding a programme name and dragging it to the place you want (except the ECO programme).

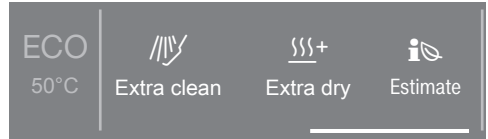

After selecting a programme, the Extras menu is displayed. This is where you can select any extras you want, activate the timer and view the energy and water consumption with the  Estimate function.

Numerical values

You can set numerical values in some menus.

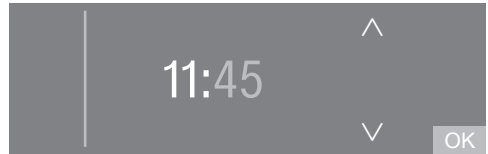

You can set the numbers by touching the numerical keypad that you want to change.

You can then set the numbers using the ∇/Δ sensor controls.

Use the OK sensor control to accept the set numerical value.

Holding down the relevant ∇ or Δ sensor control will increase or decrease the time automatically.

Caring for the environment

Disposal of the packing material

The packaging is designed to protect the appliance from damage during transportation. The packaging materials used are selected from materials which are environmentally friendly for disposal and should be recycled.

Recycling the packaging reduces the use of raw materials in the manufacturing process and also reduces the amount of waste in landfill sites.

Disposing of your old appliance

Electrical and electronic appliances often contain valuable materials. They also contain specific materials, compounds and components, which were essential for their correct function and safety. These could be hazardous to human health and to the environment if disposed of with your domestic waste or if handled incorrectly. Please do not, therefore, dispose of your old appliance with your household waste.



Please dispose of it at your local community waste collection / recycling centre for electrical and electronic appliances, or contact your dealer or Miele for advice. You are also responsible (by law, depending on country) for deleting any personal data that may be stored on the appliance being disposed of. Please ensure that your old appliance poses no risk to children while being stored prior to disposal.

Before using for the first time

Every dishwasher is tested at the factory. There will be residual water in the appliance from this test. It is not an indication that the dishwasher has been used previously.

Opening the door

In some programmes the door automatically opens slightly to assist the drying process.

This function can be deactivated, if preferred (see “Settings” chapter, “AutoOpen” section).

This dishwasher has a motorised door opener which is activated by knocking on the door front (Knock2open function).

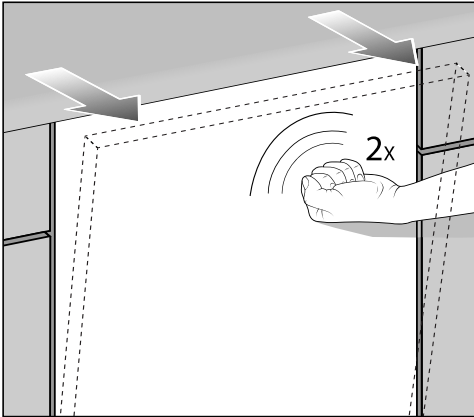

- Knock twice in quick succession on the top third of the door front.

The door will open a little.

- Hold the door at the top edge and pull the door out of the lock.

The door locking pins will retract.

To prevent a technical fault, do not hold the door locking pins firmly when they are retracting.

If the door is opened during operation all wash functions are automatically interrupted.

You can change the number of knocks required or deactivate the function (see “Settings” chapter, “Knock2open” section).

⚠ Risk of scalding due to hot water.

During operation, water in the dishwasher may be very hot.

During operation, only open the door with extreme caution.

⚠ Risk of injury due to door opening automatically.

The door may open automatically at the end of a programme.

Keep the area around the door free of obstructions.

Before using for the first time

Door-opening mechanism

If the door will not open when knocked or if there is a power failure, the door can be opened manually with the door-opening mechanism supplied with the dishwasher.

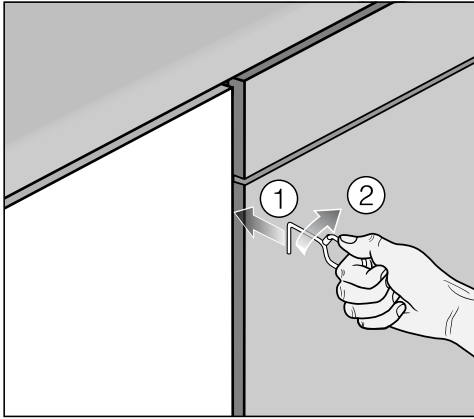

- Push the door-opening mechanism into the gap between the dishwasher front and the neighbouring unit door ① about 15 cm below the work-top.
- Turn the door-opening mechanism clockwise ②, until it grips behind the dishwasher front.

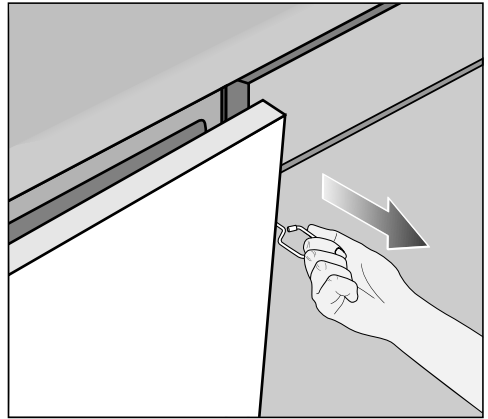

- Then use it to pull the door open.

Closing the door

- Push the baskets right in.
- Then raise the door up, and push until it clicks into position.

The door will then close automatically.

 Risk of crushing due to the door closing.

When closing the door, you are at risk of shutting your fingers in it.

Do not put your hand inside the door as it is closing.

Before using for the first time

Miele@home

Your dishwasher is equipped with an integrated WiFi module.

In order to use it you will need:

- A WiFi network
- The Miele@mobile app
- A Miele user account The user account can be created via the Miele@mobile app.

The Miele@mobile app will guide you as you connect your dishwasher to your home WiFi network.

Once your dishwasher is connected to your WiFi network you can use the app, for example, to carry out the following activities:

- Control your dishwasher remotely
- Call up information on the operating status of your dishwasher
- Call up information on the programme sequence of your dishwasher

Connecting your dishwasher to your WiFi network will increase energy consumption, even when the dishwasher is switched off.

Make sure that your WiFi network signal strength is strong enough at the installation site of your dishwasher.

Miele@home availability

The ability to use the Miele@mobile app depends on the availability of the Miele@home service in your country.

The Miele@home service is not available in every country.

For information about availability, please visit www.miele.com.

Miele@mobile App

The Miele@mobile App is available to download free of charge from the Apple App Store® or from the Google Play Store™.



Before using for the first time

Basic settings

Switching on the dishwasher

- Open the door.
- Switch the dishwasher on using the  sensor control.

The welcome screen will appear when the dishwasher is switched on and the welcome melody will sound.

For further information about the display functionality, see the “Display functions” section in the “Guide to the appliance” chapter.

Setting the language

The display will then change automatically to the screen for setting the language.

- Select the language you want as well as the country if applicable.

For further information on setting the language, see the “Language” section in the “Settings” chapter.

The set language is marked orange.

Setting up Miele@home

The message Set up Miele@home? will appear in the display.

- If you want to set up Miele@home now, select the Yes option.

Tip: To set it up at a later date, select the No option.

There are two ways of connecting your dishwasher to your WiFi network:

- Select the connection method you wish to use.

1. App
2. WPS

You will then be guided by the display and the Miele@mobile app.

For further information on Miele@home, see the “Miele@home” section in the “Settings” chapter.

Before using for the first time

Setting the time of day

The time of day is updated automatically if a connection is established with the WiFi network.

The display will then change to the screen for setting the clock format and the time of day.

The current time of day must be set before you can use the timer option.

- Select the setting you want for the clock format.
- Set the hours and the minutes and confirm by pressing *OK*.

Setting the water hardness level

The display will change to the screen for setting the water hardness.

- You should programme the dishwasher to the correct water hardness for your area.
- Your local water authority will be able to advise you of the water hardness level in your area.
- Where the water hardness fluctuates e.g. between 1.8 and 2.7 mmol/l (10 - 15 °d - German scale) always programme the dishwasher to the higher value (2.7 mmol/l or 15 °d in this example).

In the event of a fault, it will help the service technician if you know the hardness of your local water supply.

Therefore, please enter the water hardness:

_____ °d or mmol/l

The dishwasher is programmed at the factory for a water hardness level of 2.5 mmol/l (14 °d – German scale).

- Set the water hardness level in your area and confirm using *OK*.

See the “Settings” chapter, “Water hardness” section for more information.

Before using for the first time

Activating AutoDos

The display changes to the settings screen for AutoDos (see the “Detergent” chapter, “Automatic dispensing/AutoDos” section).

Even if you do not wish to use AutoDos, you must remove the transport locking device from the PowerDisk compartment before running the first programme (see the “Detergent” chapter, “Activating AutoDos” section).



You can activate AutoDos.

If you do not wish to use AutoDos (automatic dispensing), you can manually dispense the detergent via the detergent compartment (see the “Detergent” chapter, “Manual detergent dispensing” section).

- Select the setting you want and confirm with *OK*.

This setting applies to all programmes and you can change it in a programme's Extras menu.

Finally, prompts will appear in the display.

After confirming these prompts with *OK*, the messages  Add salt and run the "QuickPowerWash" programme with the "Express" option without a load and  Re-fill rinse aid may appear.

- Add salt and rinse aid if necessary (see the “Before using for the first time” chapter, “Dishwasher salt” and “Rinse aid” sections).
- Select *OK* to confirm the messages.

The selected programme will be shown briefly in the display.

Next, the estimated energy and water consumption may be shown for the chosen programme for several seconds.

Then the display will show the estimated duration for the programme selected.

You can now turn on the Hygiene cycle function (see the “Settings” chapter, “Hygiene cycle” section).

Dishwasher salt

In order to achieve good cleaning results, the dishwasher needs to operate with soft water. Hard water results in the build-up of calcium deposits on crockery and on the inner surfaces of the appliance.

Mains water with a hardness level higher than 0.9 mmol/l (5 °d – German scale) must be softened. This occurs automatically in the integrated water softener. The water softener is suitable for a water hardness level of up to 12.6 mmol/l (70 °d – German scale).

In order to maintain the water softener's functions, the water softener must be reactivated regularly. Reactivation occurs automatically every ninth programme sequence. At the start of the next programme, an additional 4.4 l of water is required for this process. Energy consumption increases by 0.015 kWh and the programme is extended by 3 minutes.

The above only applies to the ECO programme at a water hardness of 2.5 mmol/l (14 °d – German scale). For other programmes and water hardness levels, the frequency of reactivation will differ.

In order to be reactivated, the water softener requires dishwasher salt. Depending on the water hardness level (< 3.8 mmol/l, or < 21 °d – German scale), dishwasher salt is not required if combination detergents are being used (see the “Detergent” chapter, “Active ingredients” section).

If the water in your area is very soft and constantly **lower than 0.9 mmol/l (5 °d – German scale)** you do **not** need to add dishwasher salt. The salt refill indicator will automatically switch off after the water hardness has been set accordingly (see the “Settings” chapter, “Water hardness” section).

 Damage to the water softener from detergent.

Detergent will damage the water softener.

Do not fill the salt reservoir with powder or liquid detergent.

 Damage caused by using unsuitable salts.

Some kinds of salts may contain insoluble additives that can impair the functioning of the water softener.

Only use special coarse-grained dishwasher salt or other pure kitchen salt for reactivation.

If you only ever use combination detergent products in your dishwasher, you can switch off both refill reminders if you wish (see “Settings” chapter, “Refill reminders” section).

Please make sure that if you stop using combination detergents, you refill the dishwasher salt and rinse aid. Switch the refill reminders back on if required.

Before using for the first time

Filling the salt reservoir

Before filling the salt reservoir for the first time, you must fill it with approx. 2 l of water to enable the salt to dissolve.

Once the dishwasher has been used once, there is always sufficient water in the salt reservoir.



- Remove the lower basket from the wash cabinet and unscrew the salt reservoir cap.

⚠ Danger of corrosion due to saline solution.

Water or saline solution will run out of the reservoir when the cap is opened. Saline solution that runs out can cause corrosion in the wash cabinet and to the dishwasher load. The salt reservoir should therefore only be opened in order to replenish the salt.

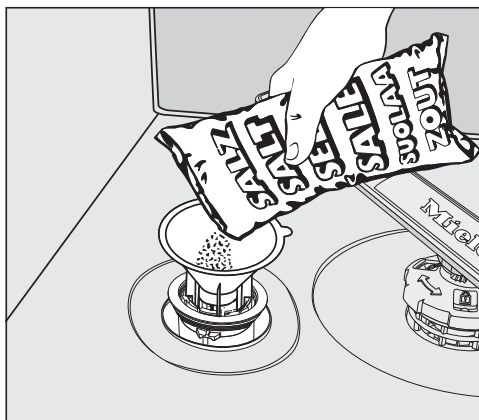
- Fill the salt reservoir with approx. 2 l of water (first use only).



- Place the funnel provided over the salt reservoir and carefully fill with dishwasher salt until the reservoir is full. The salt reservoir holds up to 2 kg of salt, depending on the type of salt used.
- Clean off salt residues from around the salt reservoir opening. Next, screw the salt reservoir cap on again firmly.
- Immediately after filling the salt reservoir and each time you remove the salt container cap, run the  65 °C *QuickPowerWash* programme with the  *Express* programme option selected without a load in the dishwasher to dissolve and remove any traces of salt from the wash cabinet.



Replenishing salt

- When  Add salt and run the "QuickPowerWash" programme with the "Express" option without a load **appears** in the display wait until the end of the programme and then refill the salt reservoir.
- Confirm with *OK*.

The salt refill indicator will disappear.

 **Danger of corrosion due to saline solution.**

Saline solution that runs out can cause corrosion in the wash cabinet and to the dishwasher load.

Each time you remove the salt reservoir cap, you must run the  65 °C *QuickPowerWash* programme with the  *Express* programme option selected without a load in the dishwasher. This will dissolve and remove any traces of salt from the wash cabinet.

After the salt reservoir has been filled, the salt refill indicator may still appear in the display if the salt concentration has not yet reached the correct level. In this case, confirm the message again with *OK*.

The salt refill indicator will be switched off if you have programmed the dishwasher for a water hardness below 0.9 mmol/l (5 °d – German scale).

Before using for the first time

Rinse aid

Rinse aid is necessary to ensure that water does not cling and leave marks on crockery during the drying phase, and helps crockery dry faster after it has been washed.

Rinse aid is poured into the container and the amount set is dispensed automatically.

 Washing-up liquid or detergent can cause damage.

Washing-up liquid and detergent can damage the rinse aid container.

Only fill it with rinse aid formulated for domestic dishwashers.

Alternatively, you could use liquid citric acid at a concentration of up to 10 %. The resulting rinsing and drying quality will not, however, be as good as when rinse aid is used.

 Risk of acid damage.

The dishwasher can be damaged by high concentrations of acid.

Under no circumstances should you use citric acid with a higher acid content.

If you only ever wish to use combination products in your dishwasher, you do not need to add rinse aid. However, for optimum rinsing and drying results, use dishwasher detergent and add dishwasher salt and rinse aid separately.

If you only ever use combination detergent products containing salt and rinse aid in your dishwasher, you can switch off both refill reminders if you wish (see “Settings” chapter, “Refill reminders” section).

Please make sure that if you stop using combination detergents, you refill the dishwasher salt and rinse aid. Switch the refill reminders back on if required.

For optimum rinsing and drying results, use dishwasher detergent and add salt and rinse aid separately.

Before using for the first time

Adding rinse aid

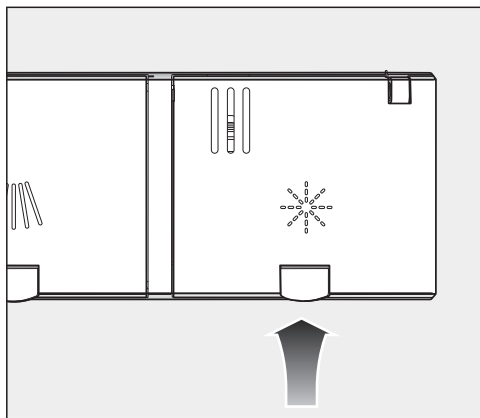

- Press the yellow button  on the lid of the rinse aid reservoir.

The lid will spring open.

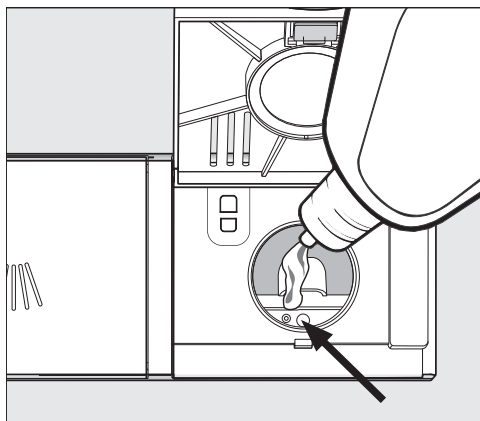

- Fill with rinse aid until the filling level indicator (arrow) changes to a dark colour while the door is horizontally open.

The rinse aid reservoir holds approximately 110 ml.

- Close the lid firmly until you hear it click into place. Otherwise, water can enter the rinse aid reservoir during a programme.
- Wipe up any spilled rinse aid. This prevents excess foam developing during the next programme.

You can adjust the rinse aid dosage for the best wash result (see “Settings” chapter, “Rinse aid” section).

Filling the rinse aid reservoir

When  Refill rinse aid appears in the display, the reservoir contains sufficient rinse aid for two to three programmes only.

- Refill with rinse aid in plenty of time.
- Confirm with OK.

The rinse aid refill reminder will disappear.

Caring for the environment

Economical dishwashing

This dishwasher is exceptionally economical in its use of water and electricity.

You can make the most of your appliance by following these tips:

- Washing in a dishwasher generally uses less water and energy than washing by hand.
- There is no need to pre-rinse items under running water, and this unnecessarily increases water and energy consumption.
- For the most economical dishwashing, make full use of the basket capacity without overloading the dishwasher. This results in the most economical dishwashing in terms of energy and water consumption.
- Choose the programme to suit the type of crockery being washed and the degree of soiling (see the “Programme overview” chapter).
- Select the *ECO* programme for energy-saving dishwashing. This programme is the most efficient in terms of its combined energy and water consumption for cleaning dishes with a normal level of soiling.
- If you have a hot water connection, choose the *SolarSave* programme (see “Installation” chapter, “Water inlet” section). The wash water will not be heated up during this programme.
- Follow the detergent manufacturer’s recommendations on detergent dosage.

- If you are manually dosing the detergent, reduce the amount of detergent by $\frac{1}{3}$ when using powder or liquid detergent if the baskets are only half full.

You can find further tips on energy-saving dishwashing in Miele’s guide to dishwashing at www.miele.com.

EcoFeedback consumption indicator

You can view information about the energy and water consumption of your dishwasher (see “Settings” chapter, “Consumption” section).

The following information will appear in the display:

- Estimated energy and water consumption before the programme sequence begins.
- Actual energy and water consumption at the end of a programme.
- The total consumption of the dishwasher.

1. Consumption estimate

You can display the predicted energy and water consumption in the Extras menu of the selected programme using the  Estimate function.

The estimated consumption will be shown as a bar chart. The more bars displayed, the higher the energy or water consumption of the selected programme.

The values are influenced by the programme, the extras selected, the ambient conditions and the size of the load.

The estimated consumption function is activated as standard. This function can be deactivated, if preferred (see “Settings”, “Consumption” section).

2. Displaying consumption

At the end of the programme, you can call up the actual energy and water consumption for the programme that has just been run.

- Open the door at the end of the programme.

- Select the  Consumption function.

The energy and water consumption of the programme that has just run is displayed.

Switching the dishwasher off at the end of the programme will delete the actual consumption values for the programme that has just been run.

3. Total consumption

You can view the total consumption of energy and water for all previously used programmes of your dishwasher (see “Settings” chapter, “Consumption” section).

Caring for the environment

EcoTech heat accumulator

This dishwasher is equipped with a heat accumulator, in which fresh water for the programme is pre-heated and stored in order to save energy. The heat accumulator is refilled with fresh water towards the end of each programme. The water is held here ready for the next programme.

If you do not wish to use this function, it can be switched off (see “Settings” chapter, “Heat accumulator” section).

If the dishwasher is disconnected from the power supply for a longer time or the water in the heat accumulator has not been used for several weeks, the water will be automatically drained off for hygiene reasons. This procedure takes a few minutes and will occur even with the appliance switched off or the door open.

Please ensure that the dishwasher is properly connected.

The display will remain dark while the heat accumulator is drained off. If you touch the  sensor control, the display will show the message `Empty heat accumulator`. Other functions will be unavailable during this procedure.

Automatic emptying cannot be interrupted.

During the subsequent programme sequence, water and energy consumption will be higher.

The heat accumulator can be manually drained for transporting the dishwasher, e.g. when moving house (see “Settings” chapter, “Heat accumulator” section).

The heat accumulator should only be used in conjunction with a cold water connection.

This function should be switched off if your dishwasher is connected to a hot water supply.

General information

Remove coarse food residues from crockery.

There is no need to pre-rinse items under running water.

 Damage can be caused by ash, sand, wax, lubricating grease or paint.

These substances will contaminate the dishwasher and can then no longer be removed.

Do not wash items soiled with these substances in the dishwasher.

Crockery can be loaded anywhere in the baskets, but the following notes should be observed:

- Do not place crockery and cutlery inside other items where they will cover one another.
- Load the crockery so that water can access all surfaces. This ensures that they get properly cleaned.
- Make sure that all items are securely positioned.
- Hollow items such as cups, glasses, pots etc. must be placed upside down in the baskets.
- Tall and narrow hollow items, such as champagne glasses, should be placed in the middle of the basket rather than in the corners. This ensures the hollow items are more easily accessed by the water jets.
- Wide-based items should be placed at an angle so that water can run off them freely.

- The spray arms must not be blocked by items that are too tall or hang through the baskets. Test for free movement by manually rotating the spray arms.

- Make sure that small items cannot fall through the holders in the baskets.
Small items such as lids should therefore be placed in the 3D MultiFlex tray or cutlery basket (depending on model).

Some foods may contain natural dyes, e.g. carrots, tomatoes or ketchup. These dyes can discolour plastic items in the dishwasher if large quantities of these foods are in contact with the crockery inside the appliance. The stability of plastic items is not affected by this discolouration.
Washing silverware can also cause plastic items to discolour.

Loading the dishwasher

Items not suitable for dishwashers:

- Wooden cutlery and crockery or items with wooden parts: these may discolour and fade. The glue used in these items is not dishwasher-proof and wooden handles may come loose after being washed in a dishwasher.
- Craft items, antiques, valuable vases and decorative glassware: such items are not suitable for dishwashers.
- Plastic items that are not heat resistant: the high temperatures in the dishwasher may cause them to melt or lose shape.
- Copper, brass, tin and aluminium items: these may discolour or become dull.
- Colours painted over a glaze: these may fade after a number of washes.
- Delicate glassware and glassware containing lead crystal: clouding may occur over time.

Silver

Silver that has been in contact with foods containing sulphur can discolour. These include egg yolk, onions, mayonnaise, mustard, pulses, fish, fish brine and marinades.

Silverware previously cleaned with a **silver polish** may still be damp or spotted at the end of a programme, where water has not run off smoothly.

Tip: Rub the silver dry with a cloth.

 Damage due to caustic alkaline detergents.

Aluminium parts (e.g. the grease filters of cooker hoods) can be damaged by caustic alkaline detergents. In extreme cases, there is a risk of an explosive chemical reaction (such as an explosive oxyhydrogen gas reaction).

Aluminium components must not be cleaned in the dishwasher with caustic alkaline commercial or industrial detergents.

Tip: When purchasing new crockery and cutlery, make sure they are dishwasher-proof if you want to wash them in the dishwasher.

Glass care

- Clouding may occur on glasses after frequent washing in the dishwasher. When washing delicate glassware in the dishwasher, ensure that only a special glass-care programme with very low temperatures is selected (see “Programme overview”). This will reduce the risk of clouding.
- Purchase glassware that is dishwasher-safe (e.g. Riedel glassware).
- Use detergents with glass protective additives.
- Visit <http://www.mieleglasscare.com> for more information on glass care.

Upper basket

See the “Loading the dishwasher” chapter, “Loading examples” section for examples of how to load crockery and cutlery.

Loading the upper basket

⚠ Damage due to leaking water.

If you run the dishwasher without the upper basket, water can leak out of the dishwasher.

Only run the dishwasher with the upper basket in place (except during the programme Tall items, if available).

- Use the upper basket for small, light-weight and delicate items such as cups, saucers, glasses, dessert bowls etc.
Shallow pans or casserole dishes can also be placed in the upper basket.
- Long items such as soup ladles and mixing spoons should be placed lying down across the front of the upper basket.

Loading the FlexCare cup rack

You can put cups, small bowls and flat crockery on the FlexCare cup rack. Glasses can be arranged along the cup rack so they sit securely during the programme.

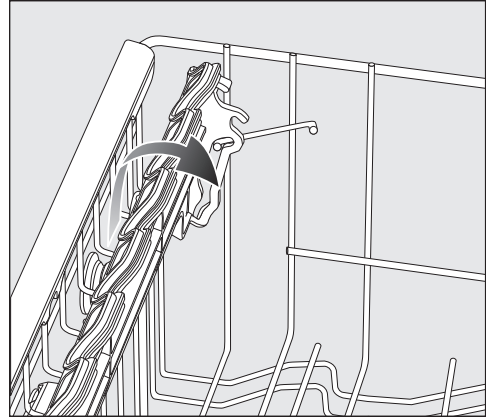

- Lower the cup rack to do so.
- Raise the cup rack upwards to make room for tall items.

Loading the dishwasher

Adjusting the FlexCare cup rack

You can set the height and depth of the cup rack at two different levels, so that it can accommodate larger cups and so that taller crockery can be placed underneath it.

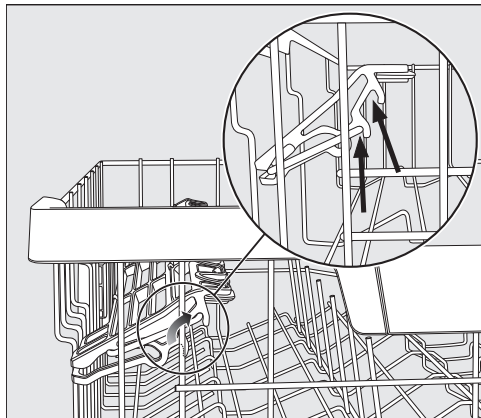

- Pull the cup rack upwards and click it into the desired position (see arrow).

Loading the silicone elements of the FlexCare cup rack

The silicone elements in the cup rack are specially designed to hold tall glasses with long stems securely.

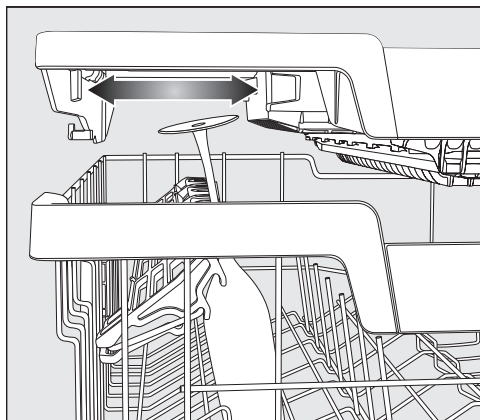

- Lower the cup rack and lean the glasses against the openings.
- If you wish you can adjust the left insert of the 3D MultiFlex tray to make space for taller glasses (see the “Cutlery” chapter, “3D MultiFlex tray” section).

Lower the spikes

On both right-hand rows of spikes, you can lower every other spike to make it easier to arrange larger crockery, like cereal bowls.

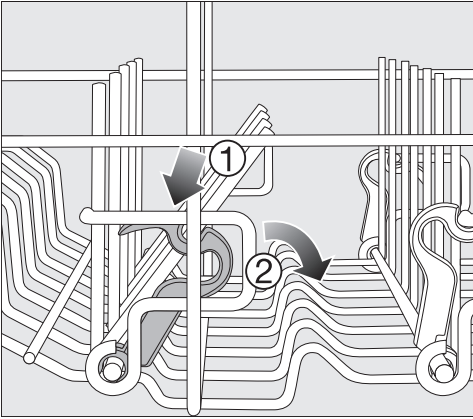

- Press the yellow lever downwards ①, and then lower the dark grey spikes ②.
- Place the bowls vertically in the row of spikes.

Loading the dishwasher

Adjust the upper basket

In order to gain more space for taller pieces of crockery in the lower or upper basket, the upper basket can be adjusted on three levels with 2 cm between each level.

The upper basket can also be set at an angle so that water can run off freely from recesses. Make sure, however, that the basket can slide smoothly in and out of the wash cabinet.

- Pull out the upper basket.

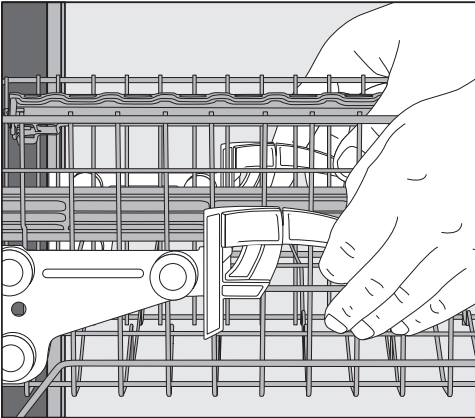

To raise the upper basket:

- Lift the basket up until it clicks into place.

To lower the upper basket:

- Pull upwards on the levers at either side of the upper basket.
- Adjust the basket to the desired height and then push the levers securely back down into position.

When adjusting the upper basket, make sure it does not block the middle spray arm.

Lower basket

See the “Loading the dishwasher” chapter, “Loading examples” section for examples of how to load crockery and cutlery.

Loading the lower basket

- Place larger and heavier items such as plates, serving platters, sauce-pans, bowls etc., in the lower basket. Glasses, cups and small plates and saucers can also be placed in the lower basket.

Loading the MultiComfort zone

The rear section of the lower basket is used for washing cups, glasses, plates and pots.

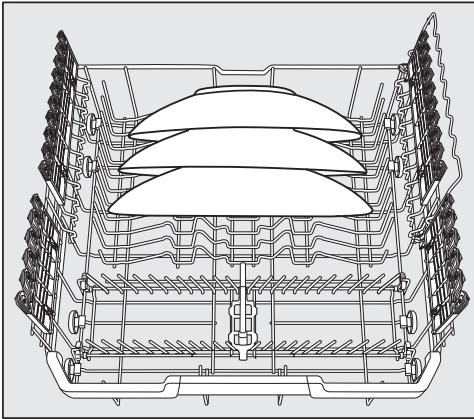

- Place very large plates in the middle of the lower basket.

Tip: When tilted, plates up to 35 cm in diameter can be accommodated.

Lower the spikes

The spikes at the front are used for washing plates, soup bowls, platters, dessert bowls and saucers.

Both rows of spikes can be lowered to make more room for large items such as pots, pans and serving dishes.

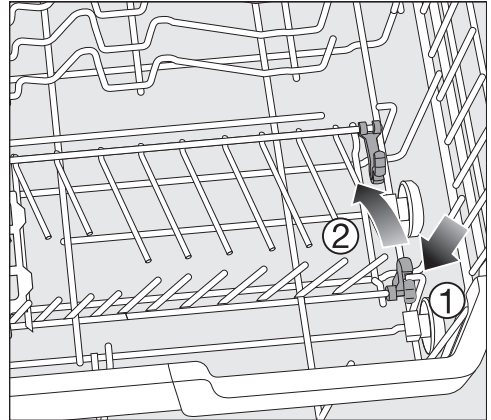

- Press the yellow lever downwards ①, and then lower the spikes ②.

Loading the dishwasher

Loading the FlexCare glass holder with MultiClips

The silicone elements in the glass holder provide a stable and secure hold for delicate stemware.

- Stemware such as wine glasses, champagne flutes and beer glasses can be leaned against the glass rack or suspended from it.
- The glass rack can be raised to make more room for tall items.

You can set the glass rack at two different heights.

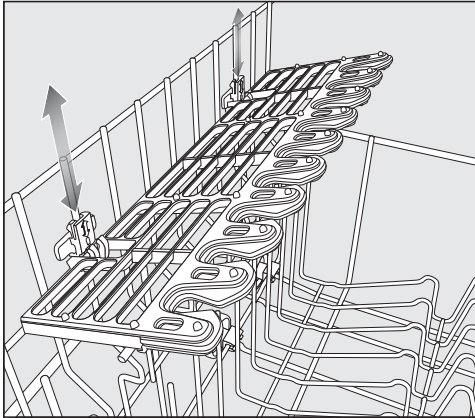

- Slide the glass rack to the desired height until the catches click into place at the top or the bottom.

The MultiClips enable you to fasten light items such as those made from plastic onto the glass holder.

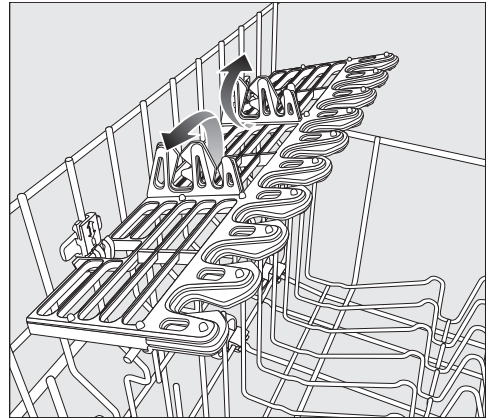

- Fold up the MultiClips.

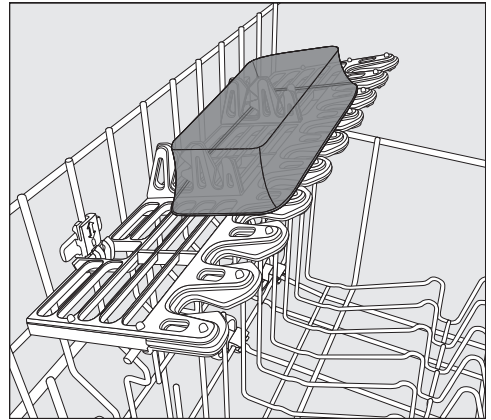

- Secure light items to the MultiClips.

Loading the dishwasher

Loading the glass rail

This rail is designed to hold glasses with long stems securely.

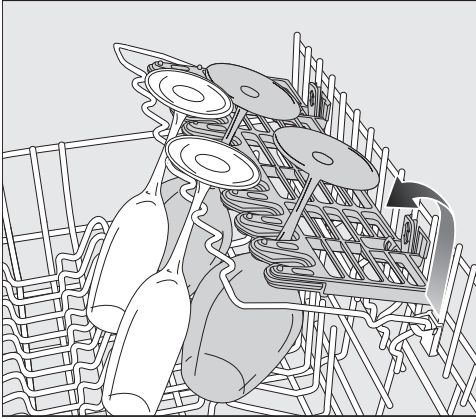

- Lower the glass rail and lean the glasses against it.

Lower the bottle holder

The bottle holder can be used to keep narrow items such as milk and baby bottles secure during a programme.

- Raise the bottle holder upwards and push it down until it clicks into place.

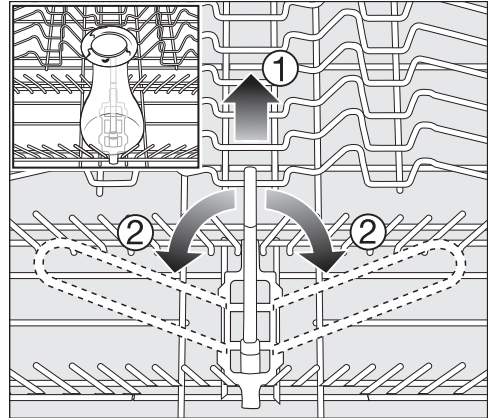

- If the bottle holder is not needed, lift it up using the yellow lever ① and fold it to the side ②.

Loading the dishwasher

Cutlery tray

See the “Loading the dishwasher” chapter, “Loading examples” section for examples of how to load crockery and cutlery.

- Load the cutlery into the 3D MultiFlex tray.

Loading the 3D MultiFlex tray

To make unloading easier, cutlery should be grouped in zones, one for knives, one for forks, one for spoons, etc.

Spoon heads should be placed in contact with at least one of the serrated retainers on the base of the cutlery tray to ensure that water runs off them freely.

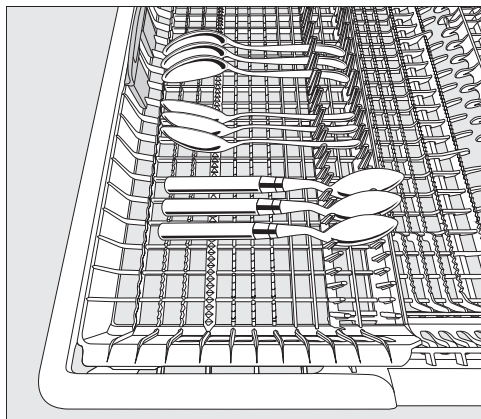

- If spoon handles do not fit between the holders, then lay them the other way round.

You can push the left insert to the middle in order to accommodate tall items of crockery and long stemmed glasses in the upper basket (see “Upper basket” chapter, “Loading the silicone elements of the FlexCare cup rack” section).

You can put large and long cutlery (such as salad servers and chef’s knives) in the recessed centre part of the tray.

Arrange tall items (such as cake slices) so that they do not block the upper spray arm.

You can adjust the height of the right-hand insert to create more space in the right-hand part of the tray for larger cutlery items or smaller pieces of crockery.

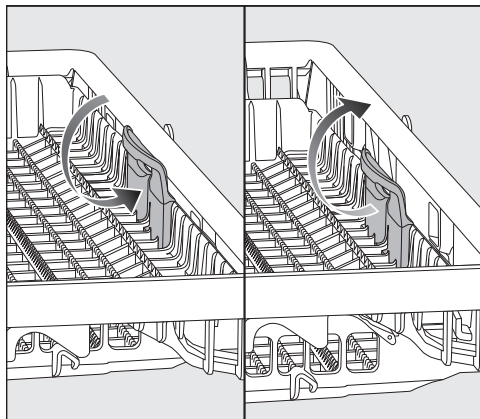

- Pull the insert inwards by the yellow handle and click it into place in one of the two positions.

Loading the dishwasher

Loading examples

Dishwashers with cutlery tray

Upper basket

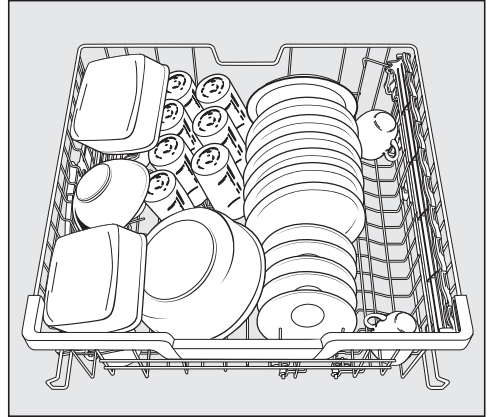
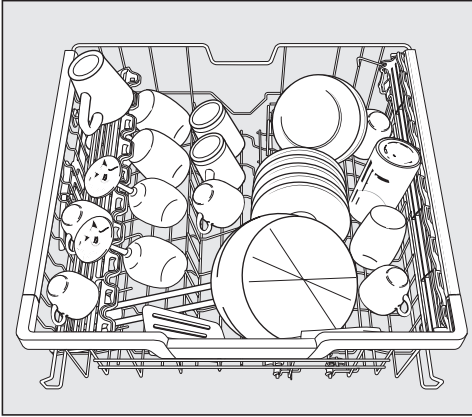

Lower basket

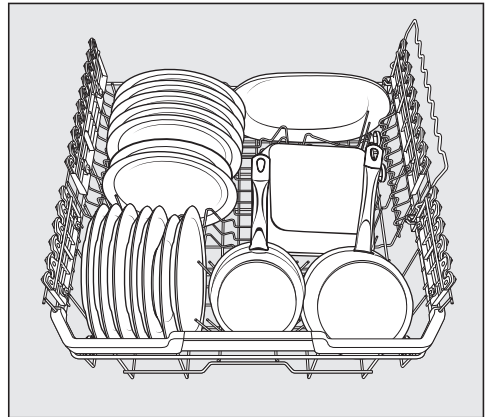
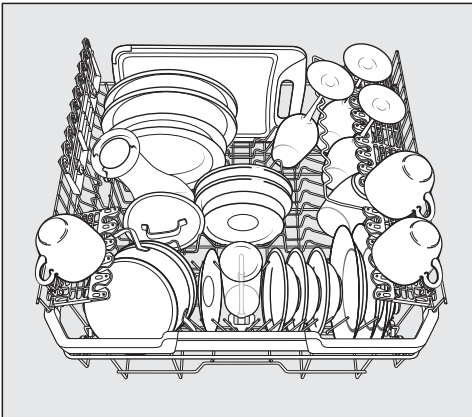

Loading the dishwasher

Cutlery tray

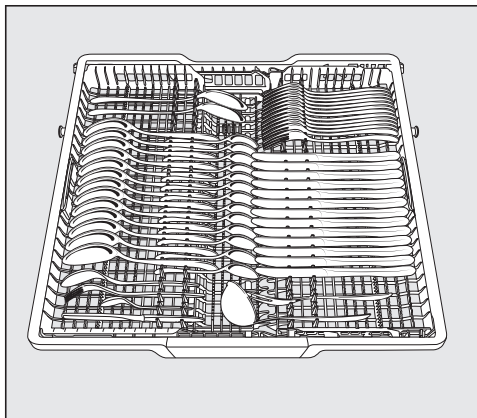
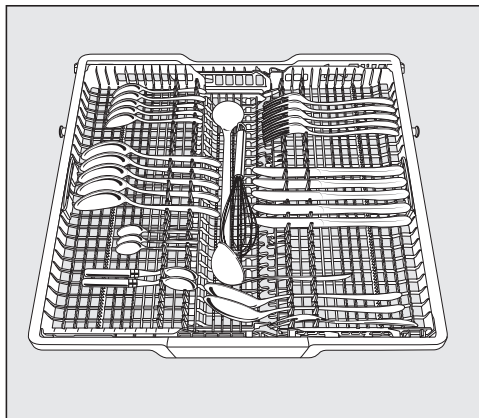

Heavily soiled items

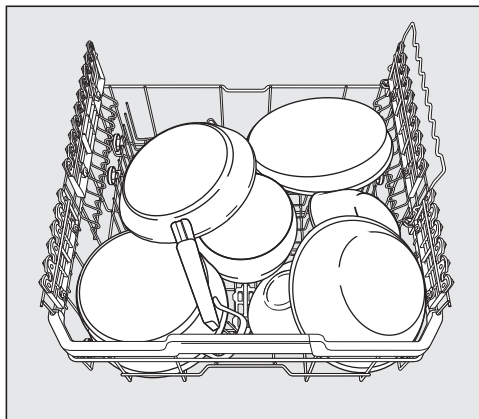

Active ingredients

 Damage caused by using unsuitable detergents.

Detergents that are not suitable for domestic dishwashers can cause damage to the dishwasher or to the load.

Only use detergents formulated for domestic dishwashers.

Modern detergents contain various active ingredients, the most important of which are:

- Water softening complexing agents to prevent calcification.
- Alkalis to aid removal of dried-on soiling.
- Enzymes to break down starch and loosen protein.
- Oxygen-based bleaching agents to remove coloured stains (e.g. tea, coffee, tomato sauce).

Most dishwasher detergents are mildly alkaline and contain enzymes and oxygen-based bleaching agents.

There are different types of detergent:

- Powder and liquid gel detergents. These detergents allow you to adjust the amount dispensed according to the size of the load and level of soiling.
- Tab detergents. These are suitable for most levels of soiling.

As well as the usual detergents, combination products are also available.

These contain rinse aid and water softener (dishwasher salt).

Only use these combination detergents for the water hardness levels recommended by the manufacturer on the packaging.

The cleaning and drying performance of these combination detergents can vary greatly.

For optimum cleaning and drying results, use dishwasher detergent and add salt and rinse aid separately.

Detergent

 Risk of chemical burns from detergent.

Dishwasher detergents can cause burning on the skin and in the eyes, nose, mouth and throat.

Avoid contact with detergents.

Do not inhale powder detergents. Do not swallow dishwasher detergents.

Seek medical attention immediately if detergent has been swallowed or inhaled.

Keep children away from detergents. Detergent residues could still be present in the dishwasher. Keep children away from the dishwasher when the door is open. Do not fill the detergent dispenser until just before starting the programme and activate the door safety lock (depending on model).

Detergent dosage

There are two ways of dispensing the detergent.

During automatic dispensing the Auto-Dos will automatically dispense the required amount of detergent for each programme sequence once a PowerDisk has been inserted (see “Detergent” chapter, “Automatic dispensing/AutoDos” section).

If you do not wish to use automatic dispensing, you can manually dispense the detergent into the detergent compartment. This means you will have to fill the required amount of detergent into the detergent compartment before each programme (see “Detergent” chapter, “Manual detergent dispensing” section).

Automatic dispensing/AutoDos

Before you can use AutoDos, you must insert a PowerDisk containing powder detergent into the PowerDisk compartment.

One PowerDisk contains enough detergent for approx. 20 cycles, depending on the chosen programme.

PowerDisks are available to order directly from Miele, from the Miele webshop, or from your Miele retailer.

 Risk of chemical burns from residual detergent.

Detergents have a caustic effect. This can cause health problems and damage to surfaces. If the AutoDos is used incorrectly or leaks, residual detergent may drip onto the floor area in front of the dishwasher.

Always remove residual detergent from in front of the dishwasher immediately.

Activating AutoDos

- Switch the dishwasher on using the  sensor control.
- Before you first use AutoDos, remove the transport lock from the PowerDisk compartment and dispose of it appropriately.
- Insert a PowerDisk (see the “Automatic dispensing/AutoDos” chapter, “Inserting a PowerDisk” section).

The *AutoDos* function will be activated automatically.

This setting applies to all programmes and you can change it in a programme's Extras menu.

If no programme is started for 48 hours, the PowerDisk will automatically be rotated so that the detergent does not clump together. If this happens, the message *Powder refresh in progress* will be shown in the display when the dishwasher is switched on. No detergent will be dispensed.

Detergent

Inserting a PowerDisk

Switch on the dishwasher before you replace the PowerDisk so that the dishwasher recognises it.

When the message **PowerDisk almost empty** appears, the reservoir contains sufficient detergent for two to three programmes only.

Only replace the PowerDisk when the message **PowerDisk empty**. Deactivate AutoDos with **OK**. **appears**.

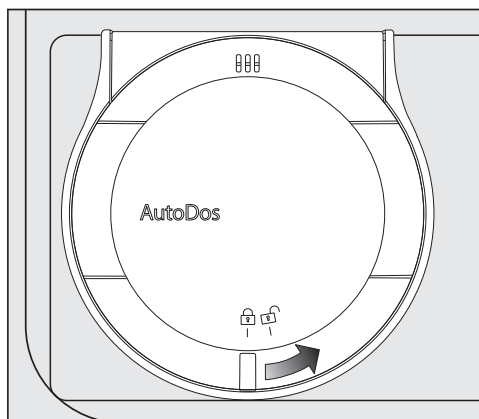

- Turn the AutoDos lid to  and open it.

The message **AutoDos lid open** will appear in the display.

- Remove the empty PowerDisk.

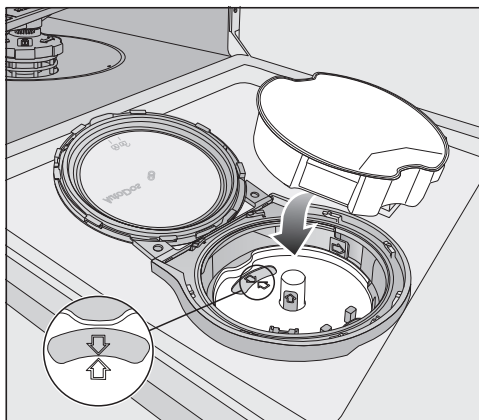

- If the arrows in the PowerDisk holder and in the viewing window are not pointing towards each other, remove the PowerDisk holder (see the “Cleaning and care” chapter, “Cleaning the AutoDos” section).
- Put the holder back into place so that the arrows point towards each other and the holder lies flat. When doing this, only touch the PowerDisk holder by the yellow tab in the middle. Do not touch the side tab.
- Insert the new PowerDisk and press it evenly downwards until it sits flush.

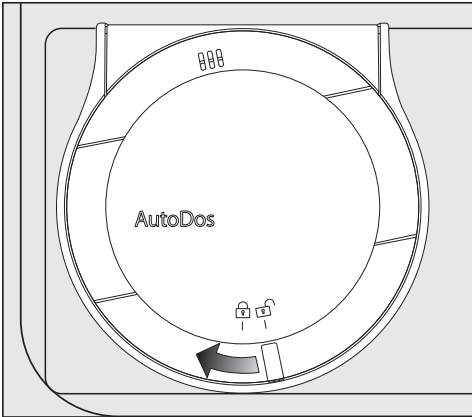

The detergent powder must be dry so that it does not clump together. Do not fill the AutoDos with any type of fluid.

In order to ensure that the AutoDos works at its best, check it each time you replace the PowerDisk and clean it if needed (see the “Cleaning and care” chapter, “Cleaning the AutoDos” section).

- Close the AutoDos lid and turn it until the lid handle is directly below the  symbol.

If the PowerDisk is not in the correct starting position, it will be rotated automatically and the *AutoDos* function will be activated.

Wait until this procedure ends before you start a programme.

The AutoDos lid must be closed to prevent damage to the AutoDos.

Always close the AutoDos lid before you close the dishwasher door. Otherwise, the AutoDos may become damaged.

Programmes cannot start when the AutoDos lid is open.

Detergent

Manual detergent dispensing

Detergent must be manually dispensed if you have deactivated automatic dispensing in a programme's Extras menu.

Detergent dispensing

The detergent compartment holds a maximum of 50 ml.

There are marks in the detergent compartment to aid with dispensing: 20, 30, max. When the door is opened to a horizontal position, they show the approximate fill level in ml and the maximum fill height.

- Follow the detergent dosage recommended by the manufacturer on the packaging.
- Unless directed otherwise, use one detergent tab or add 20 to 30 ml of detergent to the detergent compartment, depending on the level of soiling.

Failure to dispense the recommended amount of detergent may impair cleaning results.

- With very heavy soiling you can also apply a small amount of detergent to the inner panel of the door in programmes that have a pre-wash stage (see “Programme overview” chapter).

Some tabs may not dissolve completely when the programme *QuickPowerWash* is used.

Adding detergent

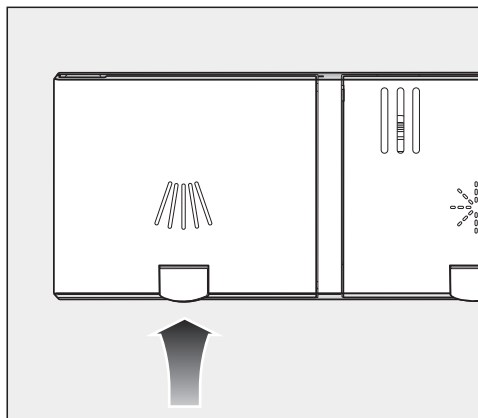

- Press the yellow button  on the lid of the detergent compartment.

The lid will spring open.

The lid will also open at the end of a programme.

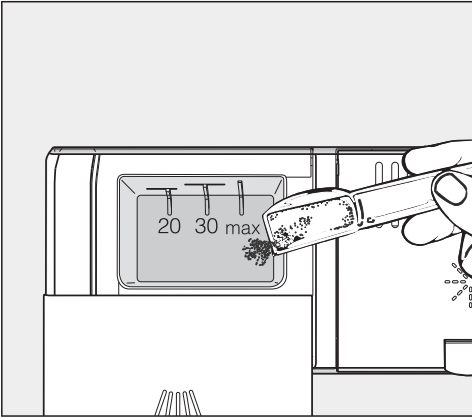



- If you wish, deactivate automatic dispensing.
- Ensure that the detergent packaging is properly closed after use. This prevents the detergent from getting damp and clumping together.

- Add the detergent to the detergent compartment.
- Push the lid shut until you hear it click into place.

The detergent must not cause the detergent compartment lid to get stuck. This can prevent the lid from opening during the programme. Do not overfill the detergent compartment.

Operation

Switching on the dishwasher

- Open the stopcock, if it is closed.
- Open the door.
- Make sure the spray arms can rotate freely.
- Touch the  sensor control.
If the dishwasher has been switched off for longer than 1 minute, you will need to hold the  sensor control for a bit longer (wipe protection).

The Programmes menu will appear in the display.

Selecting a programme

Choose your programme according to the type of load and the degree of soiling.

The different programmes and their uses are described in the “Programme overview” chapter.

- Select the programme you want in the display.

The display will change to the Extras menu.

You can now select the extras (see “Extras” chapter).

To select a different programme, touch the  sensor control to return to the Programmes menu.

Display of programme duration

The estimated duration of the selected programme appears on the display before the programme begins. If the door is opened during the programme, the time left until the end of the programme is displayed.

The displayed duration may vary for the same programme. It is influenced by, for example, the temperature of the incoming water, the reactivation cycle of the water softener, the detergent type and the amount of dishes and how soiled they are.

When a programme is selected for the first time, the display will show the average programme duration for a cold water connection.

The programme durations shown in the “Programme overview” chapter refer to standard test loads and temperatures.

Each time a programme is run, the control module calculates the programme duration according to the temperature of the water taken into the dishwasher and the size of the load.

Starting the programme

- Start the programme by closing the door.
If necessary, confirm the previously displayed message with *OK*.

The optical in-operation indicator light comes on to show that a programme sequence has been started.

If you open the door, the message *Crockery can be added* may be displayed.

As long as this message is showing, crockery can be added without compromising wash results.

 Risk of scalding due to hot water.

During operation, water in the dishwasher may be very hot.

During operation, only open the door with extreme caution.

Operation

End of programme

At the end of a programme, the optical in-operation indicator light will flash slowly with the door shut. The buzzer might also sound.

The optical in-operation indicator light will go out 10 minutes after the end of the programme if the door is closed.

The programme has ended when the display shows the message  Finished.

In some programmes, if the AutoOpen function is activated, the door will automatically open slightly (see “Settings” chapter, “AutoOpen” section). This improves the drying process.

If the Consumption programmable function is switched on, you can now call up the actual energy and water consumption of the programme that has just finished (see “Caring for the environment” chapter, “EcoFeedback consumption indicator” section).

The drying fan may continue to run for a few minutes at the end of the programme.



Risk of damage due to steam.

Steam from the dishwasher could damage the edges of delicate worktops when you open the door at the end of the programme if the fan is no longer running.

If you have deactivated the automatic door opening function (see “Settings” chapter, “AutoOpen” section), but would still like to open the door at the end of the programme, then make sure that you open the door fully.

Energy management

To save energy the dishwasher will switch off automatically 10 minutes after the last time a sensor control is pressed or after the end of a programme.

You can switch the dishwasher back on again with the  sensor control.

If the dishwasher has been switched off for longer than 1 minute, you will need to hold the  sensor control for a bit longer (wipe protection).

The dishwasher will not switch itself off whilst a programme is running or if there is a fault.

Switching off the dishwasher

- Open the door.
- The dishwasher can be switched off at any time using the  sensor control.

Switching the dishwasher off during a programme stops the programme.

You can also do this to stop an ongoing timer.



Risk of damage from leaking water.

Leaking water can cause damage. If the dishwasher is not going to be used for a longer period of time, e.g. whilst on holiday, the stopcock should be closed as a precaution.

Unloading the dishwasher

Dishes tend to break and chip more easily when they are hot. Allow the dishes to cool until they are comfortable enough to handle before unloading them.

If you open the door fully after switching off, the dishes will cool much faster.

- First unload the lower basket, then the upper basket and finally the 3D MultiFlex tray (if present). This will prevent water drops from the upper basket and 3D MultiFlex tray from falling onto the dishes in the lower basket.

Operation

Interrupting a programme

A programme will be interrupted as soon as the door is opened.

If the door is closed again, the programme will continue from the point it was at before the door was opened.

 Risk of scalding due to hot water.

During operation, water in the dishwasher may be very hot.

During operation, only open the door with extreme caution.

Cancelling or changing a programme

If a programme is cancelled, important programme stages may be missed.

A programme should only be cancelled in the first few minutes.

If a programme has already started and you wish to cancel it, proceed as follows:

- Open the door.
- Touch the ↩ Back sensor control.
- Confirm the query with Yes.

The programme is cancelled.

If you would like to select another programme:

- Touch the ↩ sensor control.

The display will change back to the Programmes menu.

- If you have dispensed detergent manually, check whether the detergent compartment is still closed. If the lid is already open, fill it with detergent again and close the lid.
- Select the programme you want, and then start it by shutting the door.

The optical in-operation indicator light comes on to show that a programme sequence has been started.

Timer ⌚

The timer ⌚ gives you several options for starting a programme at a later time. You can set the start time or the finish time of a programme. You can also use the EcoStart or SmartStart functions to benefit from cheaper energy tariffs at night.

During manual detergent dispensing the detergent will clump together if the detergent compartment is not dry, and this may mean it is not fully rinsed out.

When using the timer function, make sure that the detergent compartment is dry before adding detergent. Wipe dry with a cloth first, if necessary. Do not use any liquid detergents. These can leak out.

 **Danger to health due to detergent.**

To prevent children coming into contact with dishwasher detergent:
Do not fill the detergent dispenser **until just before starting the programme**, i.e. before you activate the timer.

Activating the timer

- Open the door.
- Switch the dishwasher on using the ⏻ sensor control.
- Select the programme you want.
- Touch the ⌚ Timer sensor control.

The ⌚ Timer sensor control lights up.

You can choose between the Start at, Finish at or EcoStart functions, or SmartStart if applicable.

- Select the function you want.

The last time set for the timer will be displayed and the hour number block will be highlighted.

- Select the time you want for the timer using the ∇∧ sensor controls and confirm with OK.

If, while you are setting the time, you do not apply any settings for several seconds, the display will revert to the previous menu. You will then have to enter your settings again.

After you have activated the timer, all the displays will switch off after a few minutes to save energy.

To switch the display back on for a few minutes, press the ⏻ sensor control.

You can also activate a timer via the Miele@mobile app.

Options

Setting “Start at”

With the *Start at* function, you set the exact time you want the programme to start at.

- Set the hours with the \vee/\wedge sensor controls.
- Touch the minute number block.
- Use the \vee/\wedge sensor controls to enter the minutes and confirm your entry by touching *OK*.

The saved start time for the selected programme will appear in the display for several minutes.

- Close the door.

When the set time is reached, the selected programme will begin automatically.

Setting “Finish at”

Use the *Finish at* function to set the latest time by which the selected programme has to be finished.

- Set the hours with the \vee/\wedge sensor controls.
- Touch the minute number block.
- Use the \vee/\wedge sensor controls to enter the minutes and confirm your entry by touching *OK*.

The estimated start time for the selected programme will appear in the display for several minutes.

A message will appear in the display if the programme cannot be completed by the set finish time because it has too long a running time. It will show the time that can be set.

- If it appears, confirm the message with *OK*.
- Close the door.

The selected programme will start automatically when the estimated start time is reached.

Setting EcoStart

You can use the EcoStart function to benefit from cheaper energy tariffs at night. Before you can use this option, you need to set up to three electrical tariff time zones (see “Settings” chapter, “EcoStart” section).

Then set the latest time by which the selected programme has to be finished by.

The dishwasher will then start automatically in the most economical tariff zone within the time set.

- Set the hours with the \vee/\wedge sensor controls.
- Touch the minute number block.
- Use the \vee/\wedge sensor controls to enter the minutes and confirm your entry by touching *OK*.

The estimated start time for the selected programme will appear in the display for several minutes.

- Close the door.

The message *Waiting for EcoStart* will appear in the display.

The selected programme will start automatically when the estimated start time is reached.

Setting SmartStart

The SmartStart function is used for starting your dishwasher automatically at a time when your energy costs are most economical.

To use this function you may need further technical accessories.

If you have activated the SmartStart function in the Settings menu, the *Timer* ⌚ menu will no longer show the EcoStart function but will instead show SmartStart (see “Settings” chapter, “Miele@home” section).

If your energy provider offers this service, they will send a signal to your dishwasher when energy costs are at their most economical.

This signal will start the dishwasher.

You can set the time by which the selected programme has to be finished by. The dishwasher will then calculate the latest possible start time for the programme selected and will wait until this start time for the signal from the energy provider.

Options

Set the time by which the selected programme has to be finished by.

- Set the hours with the \vee/\wedge sensor controls.
- Touch the minute number block.
- Use the \vee/\wedge sensor controls to enter the minutes and confirm your entry by touching **OK**.

The message **Waiting for SmartStart** will appear in the display.

- Close the door.

The selected programme will start automatically as soon as the energy provider has sent the signal or the latest possible calculated start time has been reached.

Changing and deleting the timer

You can change the time set for the timer or delete it in order to start the selected programme immediately.

Changing the timer

- Open the door.
- Touch the  timer option in the display.

You can use the \vee/\wedge sensor controls to change the time for the timer.

Deleting the timer

- Select the  option and confirm with **OK**.

The time for the timer is reset to the current time of day.

The display switches back to the Extras menu for the selected programme.



Once you have closed the door, the programme starts within one minute.

The timer stops if you switch off the dishwasher while a timer is running or touch the  sensor control and confirm the query with **Yes**.

You can also change the time set for the timer or delete it using the Miele@mobile app.

Activating Remote start

You can start your dishwasher remotely using the Miele@mobile app. To do this, you first need to install the app on your mobile device, connect the dishwasher to your WiFi network (see “Settings” chapter, “Miele@home” section) and, if applicable, activate the Remote control option (see “Settings” chapter, “Remote control” section).

- Open the door.
- Switch the dishwasher on using the  sensor control.
- Touch the  sensor control.

The  sensor control lights up.

- Switch the dishwasher off using the  sensor control.
- Close the door.

The dishwasher can now be operated remotely using the Miele@mobile app.

The Remote start option will remain activated until you deactivate it again using the  sensor control. The option will also remain active if you switch the dishwasher off and back on again in the meantime.

Even if the Remote start option is not active, you can check the status of your dishwasher and apply settings using the Miele@mobile app.





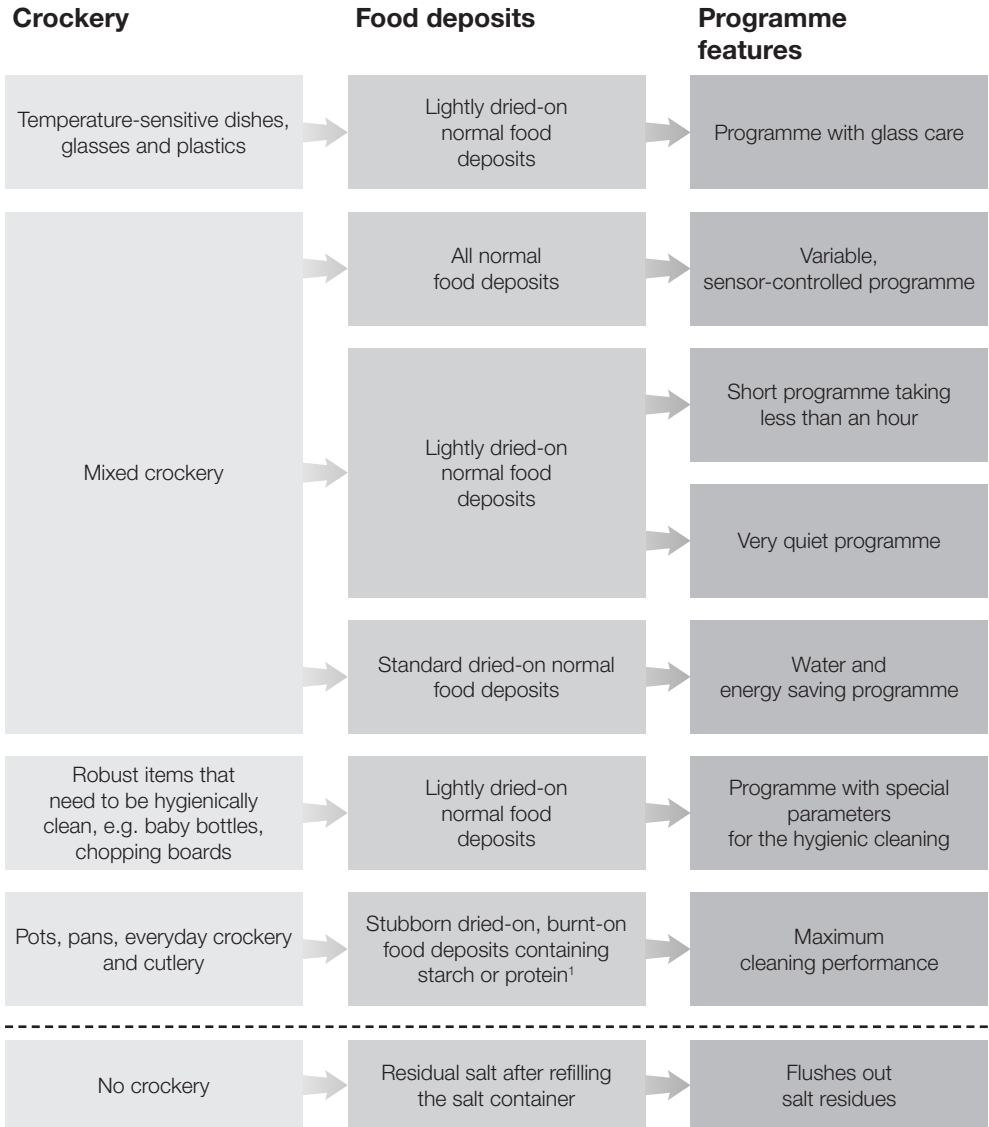































If you start a programme by closing the dishwasher door, the remote start option will automatically be activated for the duration of the programme.

Programme overview



¹ Food such as potatoes, pasta, rice or stews can leave starchy deposits. Deposits containing protein can be left by food such as fried meat or fish.

Programme overview

Programme ²	Consumption estimate ³
 Gentle 45 °C 	Energy consumption  Water consumption  Programme duration 
 Auto 45–65 °C 	Energy consumption  Water consumption  Programme duration 
 QuickPowerWash 65 °C 	Energy consumption  Water consumption  Programme duration 
 ExtraQuiet 55 °C 	Energy consumption  Water consumption  Programme duration 
 ECO 50 °C	Energy consumption  Water consumption  Programme duration 
 Hygiene 70 °C 	Energy consumption  Water consumption  Programme duration 
 Intensive 75 °C 	Energy consumption  Water consumption  Programme duration 
 QuickPowerWash 65 °C  + Express 	Programme duration 13 minutes, no heating up, solely for flushing out salt.

² All programmes can be combined with the “Express” or “IntenseZone” programme options.

³ The estimated values may change due to the selected settings or programme options, or the conditions in which the appliance is being used.

Programme overview

Programme	Programme sequence				
	Pre-wash	Main wash °C	Interim rinse	Final rinse °C	Drying
ECO 50 °C ¹	-	50	✓	46	✓
Auto 45–65 °C	Variable programme sequence, sensor-controlled adjustment to load size and level of soiling				
	As required	55–65	✓	55–70	✓
Gentle 45 °C	✓	45	✓	55–70	✓
ExtraQuiet 55 °C	-	55	✓	55–70	✓
QuickPowerWash 65 °C	-	65	✓	65	✓
Hygiene 70 °C	-	70	✓	70	✓
Intensive 75 °C	✓	75	✓	55–70	✓
Normal 60 °C	✓	60	✓	55–70	✓
SolarSave	✓✓	✓	✓	✓	✓
Tall items 65 °C	✓	65	✓	55–70	✓
Pasta/Paella	✓	75	✓	55–70	✓
Glasses	-	45	✓	55–70	-
Maintenance programme	-	75	✓✓	70	✓

¹ This programme is the most efficient in terms of its combined energy and water consumption for cleaning normally soiled crockery.

Programme overview

Consumption ²				
Electrical energy		Water	Time ²	
Cold water 15 °C kWh	Hot water 60 °C kWh	Litres	Cold water 15 °C h:min	Hot water 60 °C h:min
0.73	0.52	8.9	3:55	3:41
0.65–1.05 ^{3,4}	0.40–0.55 ^{3,4}	6.0–13.0 ^{3,4}	2:03–3:37	1:55–3:21
0.90	0.40	13.0	2:46	2:28
0.95	0.60	9.5	4:01	3:50
1.20	0.75	10.5	0:58	0:58
1.30	0.90	10.5	2:14	2:02
1.30	0.85	14.0	3:12	3:03
1.00	0.50	13.0	2:27	2:12
-	0.07	27.0	-	2:48
1.10	0.50	13.0	2:33	2:14
1.30	0.80	14.0	2:54	2:43
0.80	0.45	9.5	1:29	1:14
1.70	1.00	19.0	2:10	1:47

² Values were calculated under standardised testing conditions. In practice, the selected settings, programme options or use conditions may result in different consumption values.

³ Minimum value: half load with light soiling

⁴ Maximum value: full load with heavy soiling

Programme overview

Further programmes

SolarSave

Programme operating without heating when the dishwasher is connected to a hot water supply of at least 45 °C (see “Installation” chapter, “Water inlet” section). This programme is suitable for cleaning a mixed load with normal household food residues that have slightly dried on.

Normal 60 °C

Programme for cleaning a mixed load with normal household food residues.

Tall items 65 °C

Programme for especially large, temperature-resistant items such as very large pots/pans. In order to make space for large items in the lower basket, remove the upper basket for washing with this programme.

Pasta/Paella

Programme with long soak phases for mixed crockery, pots, pans, and non-delicate porcelain. This programme is especially suitable for removing soiling containing starch left by potatoes, pasta and rice.

Glasses

This programme does not use rinse aid and omits the drying phase. It is particularly suitable for cleaning beer glasses where a good head of froth is needed.

Maintenance programme

The dishwasher wash cabinet is generally self-cleaning. However, if residues or deposits occur, use the Maintenance programme programme to clean it. The dishwasher must not be loaded for this programme. This programme is designed for cleaning the wash cabinet using care products (dishwasher cleaner/dishwasher conditioner) (see “Optional accessories” chapter, “Appliance care” section). Follow the instructions on the packaging. When using dishwasher care products, detergent should not be dispensed. For this reason, automatic dispensing (if available) will be deactivated for this programme.

Selecting extras

You can use extras to adjust the programmes.

To do this, you can select or deselect the extras in the Extras menu of a selected programme before starting it.

- Open the door.
- Switch the dishwasher on using the  sensor control.
- Select a different programme as required.

All available extras are shown in the display.

Not all extras can be selected in every programme or used in combination. Extras that are not available are greyed out and cannot be selected.

- Select the extras you want.

The selected extras are marked in orange.

- If you want to cancel the selection of an extra, touch the sensor control for the extra again.
- When you have made all the settings you want, close the door to start the programme.

The selected extras will remain active for that particular programme until the settings are changed (except for the *ECO* programme).

Extras

IntenseZone

The *IntenseZone* extra increases cleaning performance in the lower basket.

Energy consumption increases due to the extended wash duration in the lower basket and increased temperature.

Express

The *Express* extra reduces the programme duration.

In order to achieve optimum cleaning results, the temperature, and therefore the energy consumption, will increase with this option.

The time by which the programme duration is shortened varies according to the selected programme.

Selecting the *Express* extra may take precedence over other selected options.

When used in combination with the *QuickPowerWash* programme, the *Express* extra results in a wash programme designed solely for the purpose of rinsing the cabinet to remove salt solution that leaked out after refilling the salt reservoir.

Extra clean

You can select this extra to increase the cleaning performance of the programmes.

If you activate this extra, the programme durations and the main wash temperatures will increase. The water and energy consumption may increase.

Extra dry

You can select this extra to increase the programme's drying performance.

If you activate this extra, the programme durations and final rinse temperatures will increase. The energy consumption may increase.

Check the condition of your dishwasher regularly (approx. every 4–6 months). In this way, faults and problems can be avoided.

 **Damage due to unsuitable cleaning agents.**

All surfaces are susceptible to scratching. Contact with unsuitable cleaning agents can alter or discolour the external surfaces.

Only use cleaning agents formulated for use on the relevant surfaces.

Cleaning the wash cabinet

The wash cabinet is largely self-cleaning, provided that the correct amount of detergent is always used.

However, if residues such as limescale or grease have been deposited, use the Maintenance programme programme to clean the dishwasher (see “Programme overview” chapter, “Additional programmes ” section) with dishwasher cleaner (see “Optional accessories” chapter, “Appliance care” section). Follow the instructions on the product packaging.

Miele cleaning and care products are available to order from the Miele Customer Service Department or from the Miele online shop.

- Clean the filters in the wash cabinet regularly.

Hygiene cycle

If you mainly use low temperature programmes, there is a risk of bacteria and unpleasant odours building up in the wash cabinet. To prevent this happening the dishwasher will automatically increase the temperature in the final rinse of the selected programme after several programmes using low temperatures have been run. This is to prevent the build-up of residues and odours.

This programme results in higher energy consumption.

You can activate or deactivate this function (see “Settings” chapter, “Hygiene cycle” section).

If you switch off the Hygiene cycle, run the *Intensive 75 °C* programme once per month to clean the wash cabinet and prevent odours from developing.

Cleaning the door and the door seal

The door seal and the sides of the dishwasher door cannot be reached and cleaned by the spray arm jets. As a result, mould can develop here.

- Wipe the door seals regularly with a damp cloth to remove food deposits.
- Wipe off any food or drink residues that may have dripped onto the sides of dishwasher door.

Cleaning and care

Cleaning the control panel

- The control panel should **only** be wiped with a damp cloth.

Cleaning the reflector panel

The reflector panel for the optical in-operation indicator light is situated on the cover sheeting underneath the worktop.

- The reflector panel should only be cleaned with a damp cloth if necessary.

Cleaning the appliance front



Damage due to soiling.

Soiling that is left too long might become impossible to remove and could cause the external surfaces to alter or discolour.

It is therefore best to remove any soiling immediately.

- Clean the appliance front with a clean soft sponge and a solution of warm water and washing-up liquid. After cleaning, wipe the surfaces dry using a soft cloth.
A clean, damp microfibre cloth without detergent can also be used.

To avoid damaging the external surfaces, do not use the following:

- Detergents containing soda, ammonia, acids or chlorides
- Detergents containing descaling agents
- Abrasive detergents, e.g. scouring powder, scouring liquid, or pumice stones
- Detergents containing solvents
- Stainless steel cleaning agents
- Dishwasher cleaner
- Oven cleaner
- Glass cleaning agents
- Hard, abrasive brushes or sponges, e.g. pot scourers, brushes or sponges that have been previously used with abrasive cleaning agents
- Eraser stain remover blocks
- Sharp metal scrapers
- Wire wool
- Steam cleaners

Cleaning the AutoDos

You should regularly check (about every 2–3 months when the PowerDisk is empty) that the pouring channel is clean, and clean it if necessary. This helps keep the AutoDos working properly.

In order to ensure that the AutoDos works at its best, check it each time you replace the PowerDisk and clean it if needed.

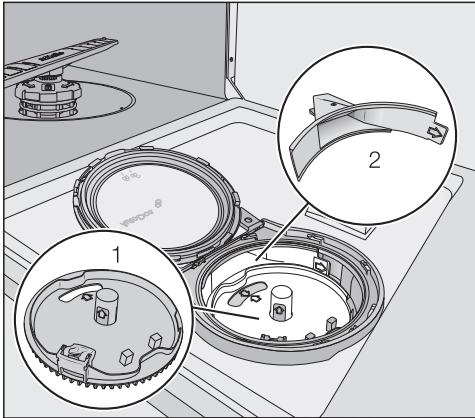

1 PowerDisk holder

2 Pouring channel for dispensing the detergent from the PowerDisk into the wash cabinet

- Turn the AutoDos lid to  and open it.
- Remove the PowerDisk if appropriate.

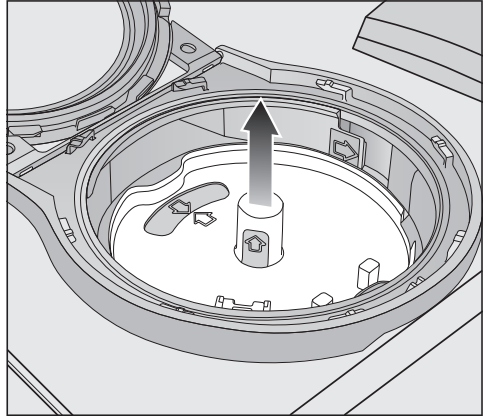

- Pull the PowerDisk holder upwards by the yellow tabs and remove it. When doing so, do not pull on the side tab.

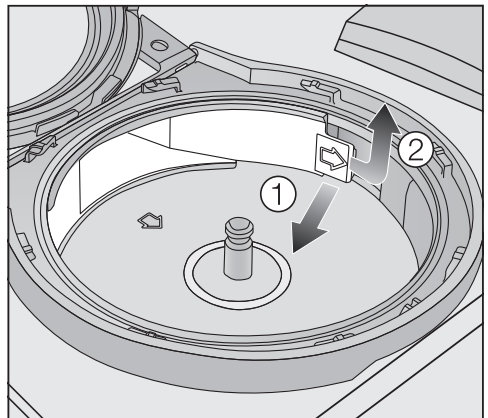

- Use the tab (see arrow) ① to release the pouring channel and pull it out ②.

Cleaning and care

- Clean the pouring channel using water and a soft brush if necessary.

It is very important that no moisture is able to access the inside of the AutoDos system during cleaning.

- Dry the pouring channel well so that the detergent powder does not clump together.
- Insert the pouring channel again until the tab clicks into place.

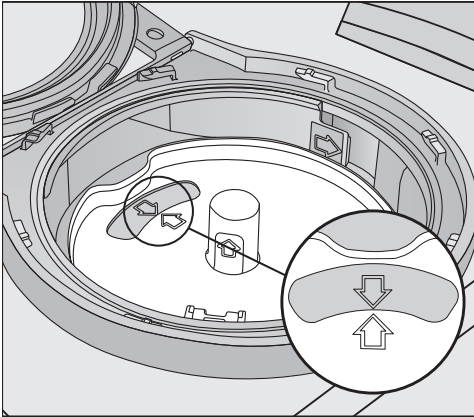

- Put the holder back into place so that the arrows in the PowerDisk holder and in the viewing window point towards each other. The holder must lie flat.

The AutoDos lid must close tightly so that the detergent powder does not get wet and clump together. Make sure that all seals are clean.

- Insert a PowerDisk.
- Close the AutoDos lid and turn it until the lid handle is directly below the  symbol. (see “Detergent” chapter, “Inserting a PowerDisk” section).

Regularly check the lower spray arm for any blockages to ensure that the detergent outlet of the AutoDos can be fully flushed out (see “Cleaning and care” chapter, “Cleaning the spray arms” section).

Cleaning the spray arms

Particles of food can get stuck in the spray arm nozzles and bearings. The spray arms should therefore be inspected regularly (approx. every 2–4 months).

⚠ Damage due to soiling entering the circulation system.

Without filters, soiling can enter the circulation system and cause a blockage.

Do not run a wash programme without the lower spray arm or without the filters.

When cleaning the filters and spray arms, make sure that coarse soiling cannot get into the circulation system.

- Switch the dishwasher off.

Removing the upper and middle spray arms

- Take out the 3D MultiFlex tray (if your dishwasher is fitted with one).
- Push the upper spray arm upwards to engage the inner ratchet. Then unscrew the spray arm by rotating the screw thread anti-clockwise.

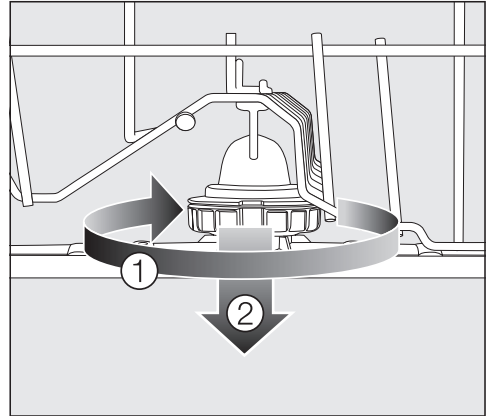

- Rotate the screw thread of the middle spray arm clockwise ① (see diagram) and remove the spray arm ②.

Removing the lower spray arm

- Remove the lower basket.

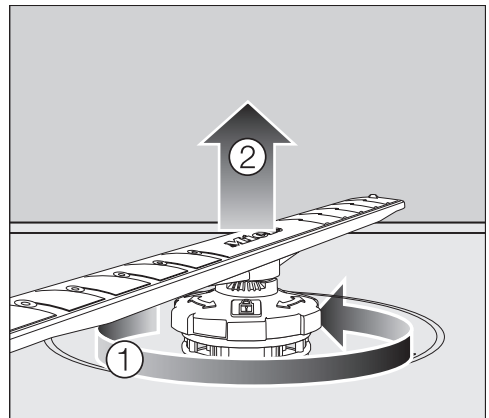

- Rotate the screw thread of the lower spray arm anti-clockwise ① and pull the spray arm upwards to remove ②.

Cleaning and care

Cleaning the spray arms

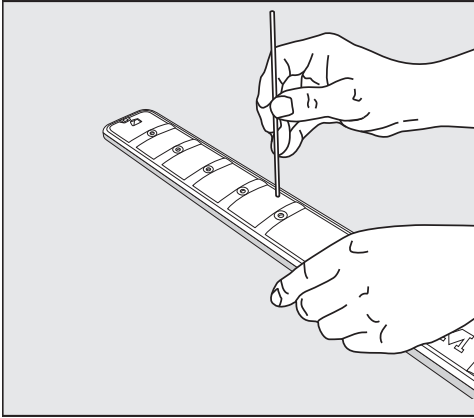



- Use a pointed object to push food particles in the nozzles into the spray arm.
- Rinse the spray arm thoroughly under running water.

Refitting the spray arms

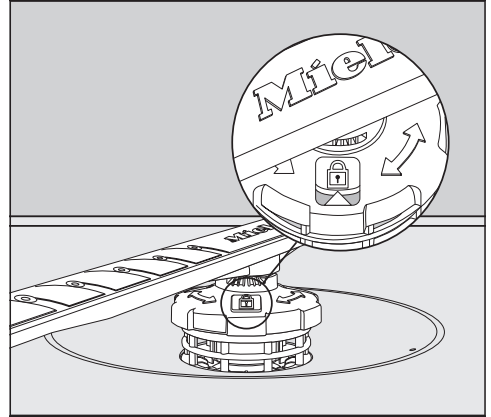
- Refit the upper and middle spray arms.
- Refit the lower spray arm and ensure that the filter combination lies flat in the base of the wash cabinet.



- Rotate the screw thread of the lower spray arm clockwise until the arrow in the viewing window points to the lock symbol .
- Make sure the spray arms can rotate freely.

 Damage due to soiling entering the circulation system.

The lower spray arm is used to secure the filter combination. Without filters, coarse soiling can enter the circulation system and cause a blockage.

Do not run a wash programme without the lower spray arm or without the filters.

Checking the filters in the wash cabinet

The filter combination in the base of the wash cabinet retains coarse soiling from the suds solution. This prevents soiling getting into the circulation system and re-entering the wash cabinet through the spray arms.

 **Damage due to soiling entering the circulation system.**

Without filters, soiling can enter the circulation system and cause a blockage.

Do not run a wash programme without the lower spray arm or without the filters.

When cleaning the filters and spray arms, make sure that coarse soiling cannot get into the circulation system.

The filters can become blocked by soiling that collects over time. The level of soiling and the time it takes before the filters need cleaning will vary depending on use.

The message **Remove filters and clean them if necessary** will appear in the display after every 50 programme cycles.

- Check the filter combination.
- Clean it, if necessary.
- Then confirm the message with **OK**.

Cleaning the filters

- Switch the dishwasher off.
- Remove the lower spray arm (see “Cleaning and care” chapter, “Cleaning the spray arms” section).
- Before removing the filter combination, remove any coarse soiling to prevent it from entering the circulation system.

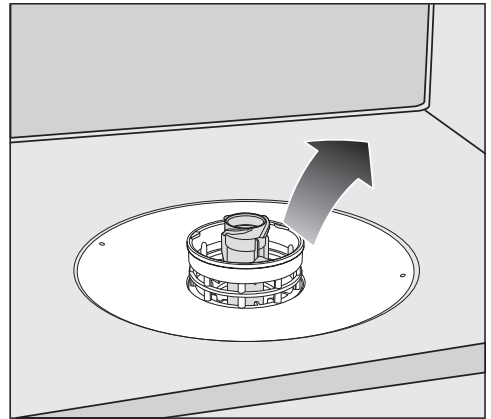

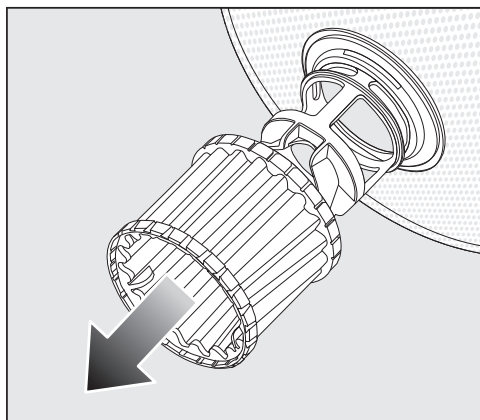

- Remove the filter combination.

Cleaning and care

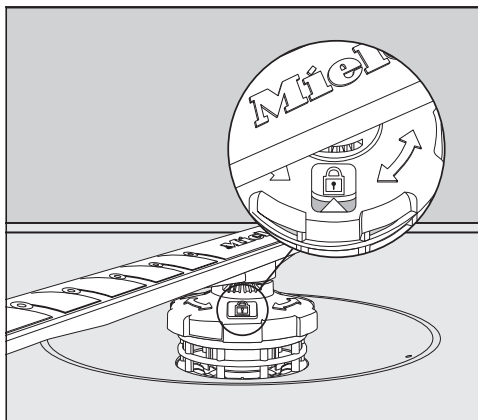

- In order to clean the inside of the filter, pull the microfilter on the plastic ring downwards and away from the filter combination.
- Rinse all the parts under running water. If necessary, use a soft cleaning brush to remove soiling.
- Insert the microfilter back into the filter combination.
- Refit the filter combination so that it lies flat in the base of the wash cabinet.
- Refit the lower spray arm to the filter combination using the screw thread.



- Rotate the screw thread clockwise until the arrow in the viewing window points to the lock symbol .

 Damage due to soiling entering the circulation system.

The lower spray arm is used to secure the filter combination. Without filters, coarse soiling can enter the circulation system and cause a blockage.

Do not run a wash programme without the lower spray arm or without the filters.

Cleaning the water inlet filter

A filter is incorporated in the screw thread to protect the water inlet valve. If the filter is soiled, insufficient water flows into the wash cabinet.

 Risk of electric shock from mains voltage.

The plastic housing of the water connection contains an electrical valve. The housing must not be dipped in water.

- Disconnect the dishwasher from the mains.
To do this, turn off the dishwasher, switch off at the socket and remove the plug.
- Close the stopcock.
- Unscrew the water inlet valve.

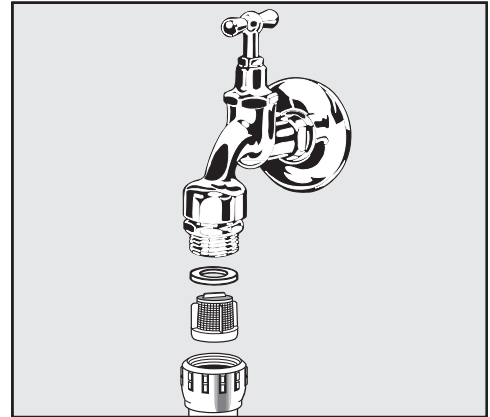

- Remove the seal from the screw thread.
- Using pointed pliers, take hold of the plastic filter slat and remove the filter.
- Rinse the filter under running water.
- Reassemble in reverse order.

Screw the screw thread securely back onto the stopcock. Slowly open the stopcock. If water drips out, tighten the screw thread.

Never forget to put the filter back in place after cleaning.

Cleaning and care

Cleaning the drain pump

If water remains in the wash cabinet after the end of a programme, the water has not been pumped away. The drain pump may be blocked by foreign objects. These are easy to remove.

- Disconnect the dishwasher from the mains.
To do this, turn off the dishwasher, switch off at the socket and withdraw the plug.
- Take the filter combination out of the wash cabinet (see “Cleaning and care” chapter, “Cleaning the filters”).
- Scoop the water out of the cabinet using a suitable small container or utensil.

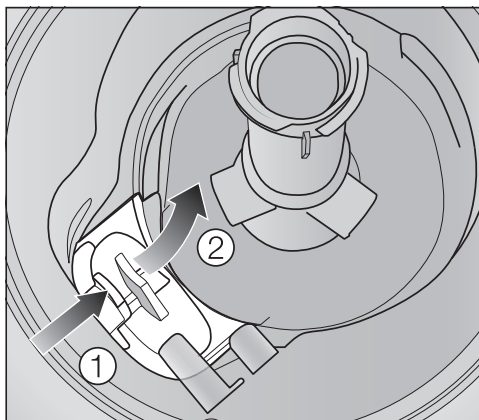

- Press the catch of the drain pump cover inwards ①.
- Tip the cover inwards until it is released ②.
- Rinse the cover thoroughly under running water and remove all foreign objects.

Cleaning and care

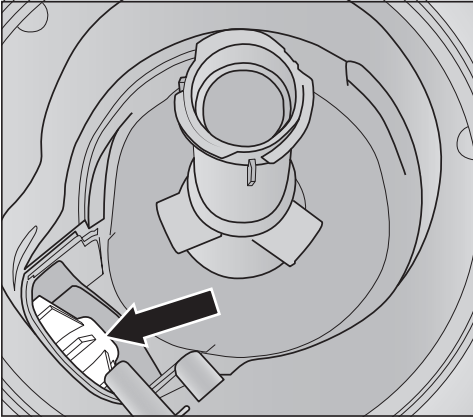

The drain pump (see arrow) is underneath the cover.

! Risk of injury from glass splinters.

It is especially difficult to see glass splinters in the drain pump.

Take care when cleaning the drain pump.

- Carefully remove all foreign objects from the drain pump. Check the drain pump impeller by manually turning it. You will feel a little resistance when you turn the impeller.
- Refit the cover by placing it down vertically from above.

Ensure that the catch engages correctly.

! Damage due to incorrect cleaning.

The components are delicate and can be damaged during cleaning. Take care when cleaning the drain pump.

Problem solving guide

Many malfunctions and faults that can occur in daily operation can be easily remedied. Time and money will be saved because a service call will not be needed.



The following guide may help you to find the reason for a malfunction or a fault, and to correct it.

This section only lists faults that you can remedy yourself. All other faults are shown in  Fault FXX.

Technical problems

Problem	Cause and remedy
The dishwasher will not start.	The door is not closed properly. ■ Raise the door upwards until the catch engages.
	The dishwasher is not plugged in. ■ Insert the plug and switch on at the socket.
	The mains fuse has tripped. ■ Reset the trip switch in the fuse box or replace the fuse in the plug (see data plate for minimum fuse rating).
	The dishwasher is not switched on. ■ Switch the dishwasher on using the  sensor control.
The dishwasher stops during a programme.	The mains fuse has tripped. ■ Reset the trip switch in the fuse box or replace the fuse in the plug (see data plate for minimum fuse rating). ■ If the mains fuse trips again, contact Miele Service.
After the programme has started, the optical in-operation indicator light is not visible.	The reflector panel was not correctly fitted. ■ Re-fit the reflector panel correctly (see installation sheet).

Fault messages



Problem	Cause and remedy
<p>The optical in-operation indicator light is flashing quickly. The alarm tone is sounding. One of the following faults appears in the display:</p>	<p>Before rectifying the problem:</p> <ul style="list-style-type: none"> ■ Switch the dishwasher off.
<p> Fault F XX: A fault has occurred; switch the appliance off and back on again. Restart the programme. If the fault occurs again, call Miele Service</p>	<p>There may be a technical fault.</p> <ul style="list-style-type: none"> ■ Switch the dishwasher back on after a few seconds. ■ Select the programme you want. ■ Close the door. <p>If the fault message appears again, there is a technical fault.</p> <ul style="list-style-type: none"> ■ Switch the dishwasher off. ■ Close the stopcock. ■ Call the Miele Customer Service Department.
<p> Waterproof fault: Switch the appliance off, close the stopcock, call Miele Service.</p>	<p>The Waterproof system has reacted.</p> <ul style="list-style-type: none"> ■ Switch the dishwasher off. ■ Close the stopcock. ■ Call Miele Service.
<p> Fault F 78: A technical fault has occurred. Switch off the appliance, close the stopcock and call Miele Service.</p>	<p>Circulation pump fault.</p> <ul style="list-style-type: none"> ■ Switch the dishwasher off. ■ Switch the dishwasher back on. ■ Select the programme you want. ■ Close the door. <p>If the fault message appears again, there is a technical fault.</p> <ul style="list-style-type: none"> ■ Switch the dishwasher off. ■ Close the stopcock. ■ Call the Miele Customer Service Department.

Problem solving guide

Door release

Problem	Cause and remedy
The optical in-operation indicator light is flashing quickly. The alarm tone is sounding. The following fault is indicated via the display:	Before rectifying the problem: <ul style="list-style-type: none">■ Switch the dishwasher off.
⚠ Fault F 33: Open the door manually. Call Miele Service	The door does not open automatically. There may be a technical fault. <ul style="list-style-type: none">■ Open the door manually (see “Before using for the first time” chapter, “Opening the door” section) and switch the dishwasher back on again.■ If the same fault message appears again, call the Miele Customer Service Department.
	The door does not close automatically. The door might be obstructed by an item inside the appliance. <ul style="list-style-type: none">■ If this is the case, remove the item causing an obstruction and switch the dishwasher on again.■ If the same fault message appears again, call the Miele Customer Service Department.

Water inlet fault

Problem	Cause and remedy
<p>The optical in-operation indicator light is flashing quickly. The alarm tone is sounding. One of the following messages appears in the display:</p>	
<p> Please open the stopcock</p>	<p>The stopcock is closed.</p> <ul style="list-style-type: none"> ■ Open the stopcock fully.
<p> Insufficient water intake. Open the stopcock fully. Refer to operating instructions if necessary</p>	<p>Before rectifying the problem:</p> <ul style="list-style-type: none"> ■ Switch the dishwasher off. <p>The water inlet is restricted.</p> <ul style="list-style-type: none"> ■ Open the stopcock fully and start the programme again. ■ Clean the filter in the water inlet (see “Cleaning and care” chapter, “Cleaning the filter in the water inlet” section). ■ The water-connection pressure is lower than 50 kPa. Seek professional advice. ■ The on-site connection for the water drainage may be too low and you will need to vent the water drainage (see “Installation” chapter, “Water drainage” section).
<p>The following fault message appears during the SolarSave programme: Intake temperature too low</p>	<p>The inlet water has not reached the required temperature of 45 °C (see “Installation” chapter, “Water inlet” section).</p> <ul style="list-style-type: none"> ■ Start the programme again. ■ If the fault message appears again, select a different programme.

Problem solving guide

Water drainage fault

Problem	Cause and remedy
<p>The optical in-operation indicator light is flashing quickly.</p> <p>The alarm tone is sounding.</p> <p>The message  Water was not pumped away, see operating instructions appears in the display</p>	<p>Before rectifying the problem:</p> <ul style="list-style-type: none">■ Switch the dishwasher off. <p>Water drainage fault.</p> <p>There might be water in the wash cabinet.</p> <ul style="list-style-type: none">■ Clean the filter combination (see “Cleaning and care” chapter, “Cleaning the filters” section).■ Clean the drain pump (see “Cleaning and care” chapter, “Cleaning the drain pump” section).■ Remove any kinks or loops in the drain hose.

Fault in the AutoDos (automatic dispensing)

Problem	Cause and remedy
<p>The message Insert PowerDisk. Deactivate AutoDos with OK. appears in the display.</p>	<p>The <i>AutoDos</i> function is active but no PowerDisk has been inserted.</p> <ul style="list-style-type: none"> ■ Insert a PowerDisk (see the “Detergent” chapter, “Automatic dispensing/AutoDos” section). ■ If you do not wish to use automatic dispensing, deactivate the function using <i>OK</i>.
<p>The optical in-operation indicator light is flashing quickly. The alarm tone is sounding. The programme does not start or a programme that has already started stops. The message AutoDos lid open appears in the display</p>	<p>The AutoDos lid has not been closed properly.</p> <ul style="list-style-type: none"> ■ Close the AutoDos lid and lock it fully (see “Detergent” chapter, “Automatic dispensing/AutoDos” section). ■ If the lid cannot be fully closed, check whether the PowerDisk holder is lying flat (see “Detergent” chapter, “Inserting a PowerDisk” section). ■ If the same fault message appears again, call the Miele Customer Service Department.
<p>The message PowerDisk empty. Deactivate AutoDos with OK. appears in the display.</p>	<p>The <i>AutoDos</i> function is active and the PowerDisk is empty.</p> <ul style="list-style-type: none"> ■ Replace the PowerDisk (see the “Detergent” chapter, “Automatic dispensing/AutoDos” section). If you do not wish to use automatic dispensing, deactivate the function using <i>OK</i>.
<p>The message PowerDisk empty. Deactivate AutoDos with OK. appears in the display even though you have inserted a new PowerDisk.</p>	<p>The dishwasher was switched off when the PowerDisk was replaced and it has therefore not recognised the new PowerDisk.</p> <ul style="list-style-type: none"> ■ Switch the dishwasher on before replacing the PowerDisk (see the “Detergent” chapter, “Automatic dispensing/AutoDos”, “Inserting a PowerDisk” section).

Problem solving guide

Problem	Cause and remedy
<p>The optical in-operation indicator light is flashing quickly. At the end of the programme, the alarm tone sounds and the display shows the following message:  Fault F 601: A fault has occurred; switch the appliance off and back on again. Restart the programme. If the fault occurs again, call Miele Service</p>	<p>There is a fault in the AutoDos.</p> <ul style="list-style-type: none"> ■ Switch the dishwasher off and back on again. ■ Check whether the PowerDisk holder and the PowerDisk have been fitted correctly (see the “Detergent” chapter, “Automatic dispensing/AutoDos” section). ■ Activate the <i>AutoDos</i> function and restart the programme. <p>If the fault message appears again, there is a technical fault. You can continue to use your dishwasher by deactivating automatic dispensing in the Extras menu of a programme and manually dispensing the detergent via the detergent compartment.</p> <ul style="list-style-type: none"> ■ If you wish to use automatic dispensing again, contact the Miele Customer Service Department.
<p>The optical in-operation indicator light is flashing quickly. At the end of the programme, the alarm tone sounds and the display shows the following message: Problem found with AutoDos. Please check AutoDos system. The dishwasher does not switch off at the end of the programme. The wash items may not be clean because an insufficient amount of detergent was dispensed. The <i>AutoDos</i> function is automatically deactivated during the programme sequence.</p>	<p>An empty PowerDisk has been inserted or the AutoDos is blocked by residual detergent. Detergent dosage is insufficient. The <i>AutoDos</i> function was automatically deactivated.</p> <ul style="list-style-type: none"> ■ Switch the dishwasher off and back on again. <p>Multiple messages appear in the display.</p> <ul style="list-style-type: none"> ■ Clean the pouring channel of the AutoDos (see “Detergent” chapter, “Cleaning the AutoDos” section). ■ Clean the lower spray arm (see “Cleaning and care” chapter, “Cleaning the spray arms” section). ■ Select <i>OK</i> to confirm each message. ■ Activate the <i>AutoDos</i> function by confirming the message <i>AutoDos</i> available using <i>OK</i>. ■ Start the programme again. <p>The programme duration will be extended by up to 2.5 hours to flush out the AutoDos detergent outlet.</p>

Spray arm fault

Problem	Cause and remedy
<p>During the programme and at the end of the programme, the display shows the following message: Check spray arms The dishwasher does not switch off at the end of the programme. The wash items may not be clean because no detergent was dispensed. The <i>AutoDos</i> function is automatically deactivated during the programme sequence.</p>	<p>The lower spray arm is blocked or the nozzles of the lower spray arm are clogged. The <i>AutoDos</i> function is automatically deactivated during the programme sequence because the <i>AutoDos</i> detergent outlet cannot be completely flushed out.</p> <ul style="list-style-type: none">■ Switch the dishwasher off and back on again. <p>Messages appear in the display.</p> <ul style="list-style-type: none">■ Perform a rotation check of the lower spray arm and rearrange the wash items if they are blocking the spray arm.■ Clean the lower spray arm (see “Cleaning and care” chapter, “Cleaning the spray arms” section).■ Select <i>OK</i> to confirm each message.■ Start the programme again.

Problem solving guide

General problems with the dishwasher

Problem	Cause and remedy
The door will not open when knocked.	<p>The Knock2open function has been permanently disabled.</p> <ul style="list-style-type: none">■ Switch the door opening function on again (see “Settings” chapter, “Knock2open” section). <p>If the door still will not open or if there is a power cut, the door can still be opened manually using the the door-opening mechanism supplied (see ”Before using for the first time” chapter, ”Door-opening mechanism” chapter).</p>
The indicator lights and the display are dark.	<p>The dishwasher has switched off automatically to save energy.</p> <ul style="list-style-type: none">■ Switch the dishwasher back on using the  sensor control.
The wash cabinet lighting does not come on when the door is opened.	<p>The wash cabinet lighting has been switched off permanently.</p> <ul style="list-style-type: none">■ Switch the lighting back on again (see “Settings” chapter, “BrilliantLight” section).
	<p>Faulty wash cabinet lighting.</p> <ul style="list-style-type: none">■ Call Miele Service.
Detergent residue is left in the detergent compartment at the end of a programme.	<p>The detergent compartment was still damp when detergent was added.</p> <ul style="list-style-type: none">■ Only add the detergent when the detergent compartment is dry.
The detergent compartment lid cannot be closed.	<p>Residual detergent is blocking the catch.</p> <ul style="list-style-type: none">■ Remove the residual detergent.
At the end of a programme there is a film of moisture on the inside of the door and possibly on the interior cabinet walls.	<p>This is part of the normal function of the drying system. The moisture will dissipate after a short while.</p>

Problem solving guide

Problem	Cause and remedy
Water remains in the wash cabinet at the end of a programme.	Before rectifying the problem: ■ Switch the dishwasher off.
	The filter combination in the wash cabinet is clogged. ■ Clean the filter combination (see “Cleaning and care” chapter, “Cleaning the filters” section).
	The drain pump is blocked. ■ Clean the drain pump (see “Cleaning and care” chapter, “Cleaning the drain pump” section).
	The drain hose is kinked. ■ Remove any kinks from the drain hose.

Problem solving guide

Noises

Problem	Cause and remedy
Knocking noise in the wash cabinet	A spray arm is knocking against a wash item. ■ Carefully open the door and rearrange the wash items that are obstructing the spray arm.
Rattling noise in the wash cabinet	Wash items are insecure in the wash cabinet. ■ Carefully open the door and rearrange the wash items so that they sit securely.
	There is a foreign object (e.g. glass shard) in the drain pump. ■ Remove the foreign object from the drain pump (see “Cleaning and care” chapter, “Cleaning the drain pump” section).
Knocking noise in the water pipes	This may be caused by the on-site installation or the cross-section of the piping. ■ However, this will not affect the functioning of the dishwasher in any way. If in doubt, contact a suitably qualified plumber.

Unsatisfactory washing result

Problem	Cause and remedy
<p>The wash items are not clean.</p>	<p>The wash items were not loaded correctly.</p> <ul style="list-style-type: none"> ■ See notes in the “Loading the dishwasher” chapter.
	<p>The programme was not powerful enough.</p> <ul style="list-style-type: none"> ■ Select a more powerful programme (see “Programme overview” chapter).
	<p>Not enough detergent was dispensed during manual detergent dispensing.</p> <ul style="list-style-type: none"> ■ Use more detergent or change the detergent you are using.
	<p>Items are blocking the path of the spray arms.</p> <ul style="list-style-type: none"> ■ Carry out a rotation check and if needed rearrange the items so that the spray arms can rotate freely.
	<p>The filter combination in the wash cabinet is not clean or was incorrectly fitted. This may have caused the spray arm jets to become blocked.</p> <ul style="list-style-type: none"> ■ Clean and/or fit the filter combination correctly. ■ Clean the spray arm jets if necessary (see “Cleaning and care” chapter, “Cleaning the spray arms” section).
<p>There are smears on glassware and cutlery. There is a bluish sheen on the surface of glassware. The film can be wiped off.</p>	<p>The rinse aid dosage is set too high.</p> <ul style="list-style-type: none"> ■ Reduce the dosage (see “Settings” chapter, “Rinse aid” section).

Problem solving guide

Problem	Cause and remedy
<p>Dishes are not dry or cutlery and glasses are flecked.</p>	<p>The rinse aid dosage is too low or the rinse aid container is empty.</p> <ul style="list-style-type: none"> ■ Replenish the rinse aid container, increase the dosage or change the brand of rinse aid (see “Before using for the first time” chapter, “Rinse aid” section).
	<p>Dishes were taken out of the wash cabinet too soon.</p> <ul style="list-style-type: none"> ■ Leave dishes in longer (see “Operation” chapter, “Unloading the dishwasher” section).
	<p>The duration of the drying phase for the selected programme is not sufficient for the dishes.</p> <ul style="list-style-type: none"> ■ Select the Extra dry extra (see “Extras” chapter, “Extra dry” section).
	<p>You have used combination products that have insufficient drying performance.</p> <ul style="list-style-type: none"> ■ Switch to another detergent, or replenish the rinse aid (see “Before using for the first time” chapter, “Rinse aid” section).
<p>Glassware has a brown or blue tinge. The film cannot be wiped off.</p>	<p>Ingredients from the detergent have formed a deposit.</p> <ul style="list-style-type: none"> ■ Switch to another detergent straight away.
<p>Glassware is dull and discoloured. The film cannot be wiped off.</p>	<p>The glassware is not dishwasher-proof. The surface has altered.</p> <ul style="list-style-type: none"> ■ No remedy. <p>Purchase glassware that is dishwasher-proof.</p>
<p>Tea or lipstick stains have not been completely removed.</p>	<p>The wash temperature of the selected programme was too low.</p> <ul style="list-style-type: none"> ■ Select a programme with a higher main wash temperature.
	<p>The bleaching effect of the detergent used is too low.</p> <ul style="list-style-type: none"> ■ Switch to another detergent.
<p>Plastic items are discoloured.</p>	<p>Natural dyes, e.g. from carrots, tomatoes or ketchup may be the cause. The amount of detergent used or its bleaching effect was not sufficient to deal with natural dyes.</p> <ul style="list-style-type: none"> ■ Use more detergent (see “Detergent” chapter). <p>Parts that are already discoloured will not revert to their original colour.</p>

Problem solving guide

Problem	Cause and remedy
<p>White residue is visible on the crockery. Clouding has occurred on glassware and cutlery. The film can be wiped off.</p>	<p>The rinse aid dosage is set too low.</p> <ul style="list-style-type: none"> ■ Increase the dosage (see “Settings” chapter, “Rinse aid” section).
	<p>There is no salt in the salt reservoir.</p> <ul style="list-style-type: none"> ■ Fill the salt reservoir (see “Before using for the first time”, “Dishwasher salt” section).
	<p>The salt reservoir cap has not been screwed on correctly.</p> <ul style="list-style-type: none"> ■ Replace it, making sure that it screws back on correctly.
	<p>Unsuitable combination detergents were used.</p> <ul style="list-style-type: none"> ■ Switch to another detergent. If using tabs or powder detergent, do not choose combination products and ensure you refill the dishwasher salt and rinse aid.
	<p>The water softener is programmed to too low a water hardness level.</p> <ul style="list-style-type: none"> ■ Programme the water softener to a higher water hardness level (see “Settings” chapter, “Water hardness” section).
<p>There are rust stains on cutlery.</p>	<p>The affected items are not corrosion resistant.</p> <ul style="list-style-type: none"> ■ No remedy. Purchase cutlery that is dishwasher-proof.
	<p>A programme was not run after dishwasher salt was added. Traces of salt have got into the normal wash cycle.</p> <ul style="list-style-type: none"> ■ Always run the  65 °C <i>QuickPowerWash</i> programme with the <i>Express</i> programme option selected and without any load in the dishwasher immediately after adding dishwasher salt.
	<p>The salt reservoir cap has not been screwed on correctly.</p> <ul style="list-style-type: none"> ■ Replace it, making sure that it screws back on correctly.

Service

Contact in case of malfunction

In the event of any faults which you cannot remedy yourself, please contact your Miele Dealer or Miele Service.

Contact information for Miele Service can be found at the end of this document.

Please note that telephone calls may be monitored and recorded for training purposes and that a call-out charge will be applied to service visits where the problem could have been resolved as described in this booklet.

Please quote the model and serial number of your appliance when contacting Miele. This information can be found on the data plate.

Warranty

For information on the appliance warranty specific to your country please contact Miele. See back cover for address.

In the UK, your appliance warranty is valid for 2 years from the date of purchase. However, you must activate your cover by calling 0330 160 6640 or registering online at www.miele.co.uk.

Note for test institutes

All information required regarding comparison testing and measuring noise levels is given in the **Comparison tests** leaflet.

Please order the latest version of this leaflet by email from:

– testinfo@miele.de

Please indicate your postal address, as well as the model and serial number of the dishwasher (see data plate).

You can also download the brochure from the Miele website.

Dishwasher detergent, rinse aid, and cleaning and care products are available for this dishwasher, as are optional accessories.

All the products have been designed for Miele appliances.

These and many other useful products can be ordered directly from Miele, from the Miele webshop, or from your Miele retailer.

Dishwasher detergent, rinse aid and salt

When selecting your Miele dishwasher, you opted for top quality and performance. To achieve optimum results all the time, it is important to use the right dishwasher products. Not all off-the-shelf products deliver the same results in all dishwashers.

For this reason Miele offers dishwasher products specifically designed for Miele appliances.

PowerDisk

Special Miele formula – for outstanding cleaning results in Miele dishwashers with AutoDos automatic dispensing.

- Exclusive Miele powder granulate
- With rinse aid and salt functions
- With components to protect silver and glass
- With active oxygen for thorough cleaning
- With super-active enzymes – effective even at low temperatures

In hard water areas, we recommend using the complete Miele system: the PowerDisk, rinse aid and salt perfectly match each other.

Detergent tabs

- Sparkling results even with stubborn food deposits
- Combination product with other functions such as rinse aid, dishwasher salt and glass protection additives
- Phosphate free – helps protect the environment
- No need to unwrap thanks to water-soluble wrapping

Powder detergent

- With active oxygen for thorough cleaning
- With enzymes that are effective even at low temperatures
- With glass-protection formula against corrosion

Rinse aid

- For sparkling glasses
- Helps crockery to dry
- With glass-protection formula against corrosion
- Specially designed cap for precise, easy dispensing

Dishwasher salt

- Prevents limescale on crockery and in the appliance
- Extra coarse-grained

Optional accessories

Appliance care

Miele cleaning and care products provide optimum care for your Miele dishwasher.

Dishwasher cleaner

- For use with the Maintenance programme programme without detergent dispensing
- Cleans the dishwasher effectively and thoroughly
- Removes grease, bacteria, and associated unpleasant odours
- Ensures excellent dishwashing results

Descaling agent

- Removes heavy limescale deposits
- Mild and gentle with natural citric acid

Conditioner

- Removes odours, limescale and light deposits
- Maintains the elasticity and leak tightness of the seals

Freshener

- Neutralises unpleasant odours
- Fresh, pleasant fragrance of lime and green tea
- Easy and convenient to attach to the dishwasher basket
- Very economical; lasts for 60 wash cycles

The Miele Waterproof system

Provided that your dishwasher has been installed correctly, the Miele Waterproof system will protect you from water damage throughout its lifetime.

Water inlet

 Danger to health due to wash water.

Water in the dishwasher is not drinking water.

Do not drink any water from the dishwasher.

 Health risk and risk of damage due to contaminated inlet water.

The quality of the incoming water must correspond to the drinking water specification of the country in which the dishwasher is being operated.

Connect the dishwasher to a drinking water supply.

The dishwasher may be connected to cold or hot water (up to max. 65 °C) supplies.

If energy-saving water heating sources such as solar energy circulation systems are used, we recommend connection to the hot water. This saves both time and electrical energy costs. Hot water is used in all programmes.

The SolarSave programme (if available) requires a hot water connection of between a minimum of 45 °C and a maximum of 65 °C (inlet temperature). The higher the water inlet temperature, the better the cleaning and drying results.

The inlet hose is approx. 1.5 m long. A 1.5 m long, flexible metal extension hose (tested to 14,000 kPa/140 bar) is available as an optional accessory from Miele specialist retailers or the Miele Customer Service Department.

Installation

A stopcock with a $\frac{3}{4}$ " threaded union is required for the connection. If a stopcock is not available, a qualified plumber should connect the dishwasher to the domestic water supply.

A non-return valve is not required. The appliance meets the requirements of the applicable DIN standards.

The water-connection pressure needs to be between 50 and 1,000 kPa. If the water-connection pressure is too high, a pressure reducing valve must be fitted.

⚠ Risk of damage from leaking water.

The connection point is subject to mains water pressure. Water leaking from it can cause damage.

You should therefore open the stopcock slowly and check for leaks. Correct the position of the washer and screw thread if appropriate.

⚠ Risk of damage due to excessive pressure.

A brief increase in the water pressure can damage components of the dishwasher.

This dishwasher must only be operated when it is connected to a fully vented plumbing system.

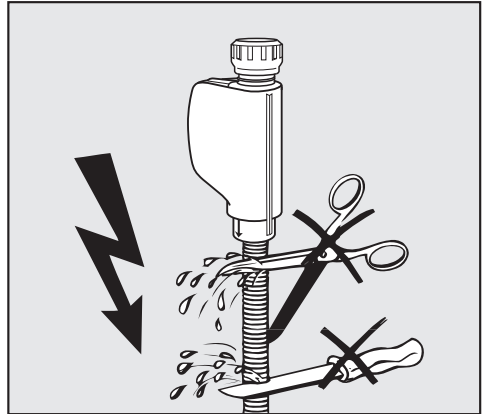

⚠ Risk of electric shock from mains voltage.

There are electrical components in the water inlet hose.

The inlet hose must not be shortened or damaged in any way (see illustration).

Water drainage

The dishwasher's drainage system is fitted with a non-return valve, which prevents dirty water from flowing back into the appliance via the drain hose.

The dishwasher is supplied with approx. 1.5 m of flexible drain hose with an internal diameter of 22 mm.

The drain hose can be extended using a connection piece to attach a further length of hose. The drainage length must not be longer than 4 m and the delivery head no higher than 1 m.

If the hose is to be directly fitted to the drainage outlet on site, use the hose clip supplied (see installation plan).

The hose can be directed to the left or the right of the appliance.

The on-site connector for the drain hose can be adapted to different hose diameters. If the connector extends too far into the drain hose, it must be shortened. Otherwise, the drain hose can become blocked.

The drain hose must not be shortened.

Lay the drain hose so that it does not kink and is not being subjected to pressure or tugged.

 Risk of damage from leaking water.

Leaking water can cause damage. After commissioning, make sure that the water is not leaking.

Installation

Venting the water drain

If the on-site drainage connection is situated lower than the guide path for the lower basket rollers in the open door, the drainage system must be vented. Otherwise, a siphoning effect during a programme can cause the appliance to empty itself of water.

- Open the dishwasher door fully.

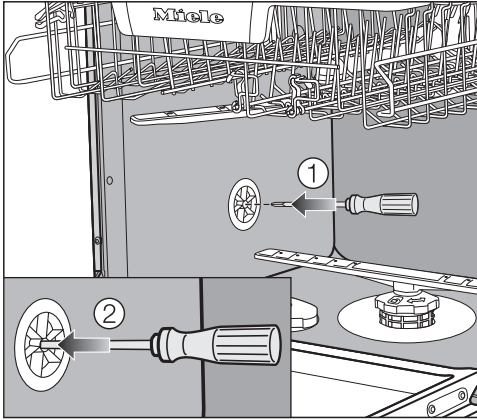

- Remove the lower basket.
- Insert a screwdriver into the middle opening of the vent valve in the left wash cabinet wall ①.
- Press the screwdriver further into the opening and push it through the membrane ② behind.

The vent opening for the water drain is now open.

Electrical connection

The dishwasher is supplied with a mains cable with moulded plug ready for connection to an earthed socket.

 Danger of suffocation due to gases.

Connecting the dishwasher to a multi-socket plug adapter or to an extension lead can overload the cable. This can cause a fire, releasing toxic gases.

For safety reasons, do not use an extension lead or multi-socket plug adapter.

 Risk of fire from overheating.

Connecting the dishwasher to a multi-socket plug adapter or to an extension lead can overload the cable.

For safety reasons, do not use an extension lead or multi-socket plug adapter.

The socket must be easily accessible after the dishwasher has been installed.

If the connection cable is damaged, it must only be replaced with a specific connection cable of the same type (available from Miele). For safety reasons, such replacement may only be carried out by a qualified technician or Miele Service.

Do not connect the dishwasher to a stand-alone inverter such as those used with an autonomous energy source e.g. **solar power**. When the appliance is switched on, power surges could result in a safety switch-off. This could damage the electronic module.

The dishwasher must not be used with **energy-saving devices** either. These reduce the amount of energy supplied to the appliance, causing it to overheat.

Before connecting the appliance, check that the connection data on the data plate (voltage, frequency and fuse rating) match the mains electricity supply and that the installed socket system matches that of the dishwasher. If in any doubt, consult a qualified electrician.

For technical data see the data plate located on the right side of the door.

The electrical installation must be comply with current local and national safety regulations (e.g. VDE 0100 in Germany/BS 7671 in the UK).

Technical data

Technical data

Dishwasher model	Normal	XXL
Height	80.5 cm (adjustable by +6.5 cm)	84.5 cm (adjustable by +6.5 cm)
Height of building-in niche	Min. 80.5 cm (+6.5 cm)	Min. 84.5 cm (+6.5 cm)
Width	59.8 cm	59.8 cm
Width of building-in niche	60 cm	60 cm
Depth	57 cm	57 cm
Weight	max. 47 kg	max. 54 kg
Voltage	See data plate	
Rated load	See data plate	
Fuse rating	See data plate	
Test certifications awarded	See data plate	
Water pressure	50–1,000 kPa (0.5–10 bar)	50–1,000 kPa (0.5–10 bar)
Hot water connection	Up to max. 65 °C	Up to max. 65 °C
Delivery head	Max. 1 m	Max. 1 m
Drainage length	Max. 4 m	Max. 4 m
Connection cable	Approx. 1.7 m	Approx. 1.7 m
Capacity	13/14 place settings*	13/14 place settings*

* Depending on model

Technical data

Dishwasher model	Normal	XXL
Power rating when switched off	0.4 W	0.4 W
Power rating when not switched off	8.0 W	8.0 W
Networked standby	1.0 W	1.0 W
Frequency band of the WiFi module	2.412 GHz–2.472 GHz	
Maximum transmission power of the WiFi module	< 100 mW	

Conformity declaration

Miele hereby declares that this dishwasher complies with Directive 2014/53/EU.

The complete text of the EU declaration of conformity is available from one of the following internet addresses:

- Products, Download from www.miele.co.uk
- For service, information, operating instructions etc: go to www.miele.co.uk/domestic/customer-information-385.htm and enter the name of the product or the serial number

Technical data

Data sheet for household dishwashers

In acc. with delegated regulation (EU) No. 1059/2010

MIELE	
Model name/identifier	G 7960 SCVI
Rated capacity in standard place settings, for the standard cleaning cycle	14
Energy efficiency class	
A+++ (most efficient) to D (least efficient)	A+++
Annual energy consumption (AE _c) ¹	208 kWh/year
Energy consumption of the standard cleaning cycle (E _c)	0,73 kWh
Weighted power consumption in off-mode (P _o)	0,40 W
Power consumption in left-on mode (P _l)	8,00 W
Weighted annual water consumption (AW _c) ²	2.492 Litres/year
Drying efficiency class	
A (most efficient) to G (least efficient)	A
Standard programme to which the information in the label and the fiche relates ³	ECO
Programme time for the standard cleaning cycle	235 min
Duration of the left-on mode (T _l) ⁴	10 min
Airborne acoustical noise emissions	42 dB(A) re 1 pW
Built-in	•

- Yes, standard feature

¹ Based on 280 standard cleaning cycles using cold water fill and the consumption of the low power modes. Actual energy consumption will depend on how the appliance is used.

² Based on 280 standard cleaning cycles. Actual water consumption will depend on how the appliance is used.

³ This programme is suitable to clean normally soiled tableware and is the most efficient programme in terms of combined energy and water consumption.

⁴ If the household dishwasher is equipped with a power management system.

Data sheet for household dishwashers

In acc. with delegated regulation (EU) No. 1059/2010

MIELE	
Model name/identifier	G 7965 SCVI XXL
Rated capacity in standard place settings, for the standard cleaning cycle	14
Energy efficiency class	
A+++ (most efficient) to D (least efficient)	A+++
Annual energy consumption (AE _c) ¹	208 kWh/year
Energy consumption of the standard cleaning cycle (E _c)	0,73 kWh
Weighted power consumption in off-mode (P _o)	0,40 W
Power consumption in left-on mode (P _l)	8,00 W
Weighted annual water consumption (AW _c) ²	2.492 Litres/year
Drying efficiency class	
A (most efficient) to G (least efficient)	A
Standard programme to which the information in the label and the fiche relates ³	ECO
Programme time for the standard cleaning cycle	235 min
Duration of the left-on mode (T _l) ⁴	10 min
Airborne acoustical noise emissions	42 dB(A) re 1 pW
Built-in	•

- Yes, standard feature

- ¹ Based on 280 standard cleaning cycles using cold water fill and the consumption of the low power modes. Actual energy consumption will depend on how the appliance is used.
- ² Based on 280 standard cleaning cycles. Actual water consumption will depend on how the appliance is used.
- ³ This programme is suitable to clean normally soiled tableware and is the most efficient programme in terms of combined energy and water consumption.
- ⁴ If the household dishwasher is equipped with a power management system.

Settings

You can alter the dishwasher's controls to suit changing requirements by adjusting the settings.

The settings can be altered at any time.

Opening the settings menu

- Switch the dishwasher on using the  sensor control.

The Programmes menu will appear in the display.

For further information about the display functionality, see the "Display functions" section in the "Guide to the appliance" chapter.

- Switch to the main menu using the  sensor control.
- Touch the **Settings** sensor control.

The display will change to the **Settings** menu.

Changing settings

- Select the setting you want to change.

The selected setting is marked in orange.

- Change the value displayed and confirm with *OK*.

or

- Touch an option to select it.
- To exit a sub-menu again, use the  **Back** sensor control.

The display will revert to the menu above.

Closing the settings menu



- Touch the  sensor control.

The display will change to the main menu.

Language

The display can be set to appear in one of several different languages.

You can change the language used in the display and also the country via the Language  sub-menu.

The flag after the word Language  serves as a guide if a language that you do not understand has been set. In this case keep selecting the menu option that has a flag after it until you reach the Language  sub-menu.

Time

The current time of day must be set before you can use the timer option.

Setting the clock format

You can select either a 24-hour or 12-hour clock.

- Select the setting you want for the clock format.

Setting the time of day

You can set the current time of day.

- Set the hours and the minutes and confirm by pressing *OK*.

The time of day has now been saved.

Settings

Water hardness

Your dishwasher is fitted with a water softener.

- You should programme the dishwasher to the correct water hardness for your area.
- Your local water authority will be able to advise you of the water hardness level in your area.
- Where the water hardness fluctuates e.g. between 1.8 and 2.7 mmol/l (10–15 °d - German scale) always programme the dishwasher to the higher value (2.7 mmol/l or 15 °d in this example).

If the water hardness in your area is available in a unit other than °d, you can convert the values as follows:
 $1\text{ °d} = 0.18\text{ mmol/l} = 1.78\text{ °f}$

Setting the water hardness level

- Select the water hardness level in your area and confirm using *OK*.

AutoDos (automatic dispensing)

If you later wish to change the fill level or dispensing amount of the PowerDisk, you can adjust the pre-set values according to the information on the packaging.

These settings are important in order for the PowerDisk almost empty message to be displayed correctly. These settings have no influence on the amount of detergent dispensed in each wash programme.

Setting PowerDisk fill level

The PowerDisks currently available contain 400 g of detergent.

- Select the PowerDisk fill level menu option and confirm with *OK*.
- Enter the PowerDisk fill quantity and confirm with *OK*.

Setting Dosage amount

The PowerDisks currently available dispense approximately 7 g of detergent per rotation.

- Select the Dosage amount menu option and confirm with *OK*.
- Select the dispensing quantity of the PowerDisk and confirm with *OK*.

Rinse aid

You can adjust the rinse aid dosage for best results.

The rinse aid dosage can be set from 0 to 6 ml.

3 ml is the factory default setting.

The rinse aid dosage can turn out to be higher than the set value due to the automatic adjustment of the programme.

If spots appear on crockery and glassware:

- Increase the rinse aid dosage.

If clouding or smearing appears on crockery and glassware:

- Decrease the rinse aid dosage.

Miele@home

Your dishwasher is equipped with an integrated WiFi module.

You can connect your dishwasher to your WiFi network.

This will increase the energy consumption, even when the dishwasher is switched off.

The “Settings” and “Miele@home settings” menus will be added as additional menu options.

Make sure that your WiFi network signal strength is strong enough at the installation site of your dishwasher.

There are a number of ways of connecting your dishwasher to your WiFi network:

Settings

App

The Miele@mobile app is available to download free of charge from the Apple App Store® or from the Google Play Store™.



- Select the App menu option and confirm with *OK*.
- Follow the instructions in the app.

Once your dishwasher is connected to your WiFi network, you can use the app to carry out the following tasks:

- Control your dishwasher remotely
- Call up information on the operating status of your dishwasher
- Call up information on the programme sequence of your dishwasher
- Set up a Miele@home network with other WiFi-enabled Miele appliances

WPS

As an alternative to networking via the Miele@mobile app, you can connect your dishwasher to your WiFi network using WPS (Wireless Protected Setup).

Your WiFi router must support WPS.

- Confirm the message Press the WPS button on your router. with *OK*.
- Activate the WPS function on your router within two minutes.
- Once the connection has been established, confirm the message with *OK*.

If the connection fails, you have probably not activated WPS on your router quickly enough. Repeat the steps above.

Deactivate

If you do not wish to use the WiFi module of your dishwasher, you can switch it off.

- Select the **Deactivate** menu option and confirm with **OK**.

In the **Miele@home** menu, the menu option **Activate** will now be displayed instead of **Deactivate**.

Activate

If you wish to connect your dishwasher to your WiFi network, you can turn on the WiFi module.

- Select the **Activate** menu option and confirm with **OK**.

In the **Miele@home** menu, the menu option **Deactivate** will now be displayed instead of **Activate**.

Display Connection status

You can call up the current connection status of your dishwasher.

- Select the **Connection status** menu option and confirm with **OK**.
- Use the \vee/\wedge sensor controls to consecutively call up the WiFi signal strength, the name of your router and the associated IP address.
- Select **OK** to confirm the messages.

Set up again

This menu option only appears if you have already connected your dishwasher to your WiFi network.

Connecting via the app

- Select the **App** menu option and confirm with **OK**.
- Follow the instructions in the app.

Connecting via WPS

- Select the **WPS** menu option and confirm with **OK**.
- Follow the instructions in the display.

Settings

Remote control

This menu option will only be displayed if you have connected your dishwasher to your WiFi network (see “Settings” chapter, “Miele@home” section)

If you wish to permanently switch off the Remote control option, you can do this under this menu option. The  sensor control will then no longer be available to select until you change this setting again.

Even if the Remote control option is switched off, you can use Miele@mobile to call up information about your appliance. However, you cannot start any programmes or change any settings from it.

Remote Update

The RemoteUpdate menu option is only displayed and can only be selected if the requirements for using Miele@home have been met (see “Before using for the first time” chapter, “Miele@home” section).

The RemoteUpdate function is used for updating the software in your dishwasher. If an update is available for your dishwasher, it will automatically download it. Updates will not be installed automatically. They must be initiated manually.

If you do not install an update, you can continue to use your dishwasher as usual. However, Miele recommends installing updates.

Activating/deactivating

The RemoteUpdate function is activated as standard. Available updates will be downloaded automatically and will only be installed if you initiate them.

Deactivate RemoteUpdate if you do not wish any updates to be downloaded automatically.

Running a RemoteUpdate

Information about the content and scope of a RemoteUpdate will be provided in the Miele@mobile app.

A message will appear in your dishwasher display if a software update is available.

You can install the update immediately or postpone it until later. When the appliance is switched on again, you will be reminded about the update.

Switch RemoteUpdate off if you do not wish to install updates.

Updates may take several minutes.

Please note the following information about the RemoteUpdate function:

- You will only receive a message when an update is available.
- Once an update has been installed, it cannot be undone.
- Do not switch the dishwasher off during the update. Otherwise, the update will be aborted and will not be installed.
- Some software updates can only be carried out by Miele Service.

SmartStart

This menu option will only be displayed if you have connected your dishwasher to your WiFi network (see “Settings” chapter, “Miele@home” section)

The SmartStart function is used for starting your dishwasher automatically at a time when your energy costs are most economical.

To use this function you may need further technical accessories.

If you have activated SmartStart Permitted, the Timer ⌚ menu of the selected programme will no longer show EcoStart but will instead show SmartStart. The dishwasher will then start within the timeframe specified when it receives a signal from the energy supplier. If it has not received a signal from the energy supplier by the latest possible start time, the dishwasher will start automatically.

Settings

EcoStart

In order to run your dishwasher in the most economical way, you can use the EcoStart option to take advantage of your electricity supplier's cheaper energy tariffs (see "Options" chapter, "Timer" section).

With this option selected, your dishwasher will start automatically at your electricity supplier's cheapest tariff times.

To use this option, you must first set up to three energy tariff time zones in which the dishwasher can start. You can allocate different priorities to these time zones. The time with the cheapest energy tariff will be given Priority 1.

Contact your electricity supplier to find out the times of the cheapest energy tariffs.

Once the energy tariff times have been set, you can use the EcoStart option to set the latest finish time required for each programme.

The dishwasher will then start automatically during the cheapest energy tariff time. The programme will end at the set finish time at the latest.

Setting the energy tariff times

Before you can use the EcoStart option, you must set at least one energy tariff time.

- Select an energy tariff time to set from T1 to T3.

The start of the energy tariff time selected will be displayed.

- Set the hours and minutes for the start time.

- Select Finish.

The end of the energy tariff time selected will be displayed.

- Set the hours and minutes for the end time and confirm both with *OK*.

The energy tariff time will be saved.

You can now select the priority of the saved energy tariff time.

- Select the priority you want.

The selected settings are displayed.

The energy tariff time will be activated.

Changing the energy tariff times

You can change the start, end or priority of an energy tariff time.

- Select an energy tariff time to change from T1 to T3.
- Select the setting you want to change.
- Change the setting and confirm with *OK*.

The selected settings are displayed.

The change will be saved.

Deleting the energy tariff times

You can delete the settings for an energy tariff time and in doing so deactivate the *EcoStart* option for this time zone.

- Select an energy tariff time to delete from T1 to T3.
- Select  Delete.
- Confirm the query with *Yes*.

The settings for the energy tariff time selected will be reset.

- Confirm the message with *OK*.

The energy tariff time will be deleted.

Settings

Consumption (EcoFeedback)

You can set whether the energy and water consumption is displayed for the selected programme. This function shows the estimated consumption before a programme, and the actual consumption after the end of the programme.

You can also call up the total consumption of energy and water for all the wash programmes you have previously run on your dishwasher (see “Caring for the environment” chapter, “EcoFeedback consumption data” section).

Display Display consumption

- Select the Display consumption menu option.
- Select the setting you want.

Display Total consumption

- Select the Total consumption menu option.

The values for energy and water are displayed.

You can delete the values for the total consumption.

- Select the  menu option.
- Select the Yes menu option.

The values are deleted.

Temperature

The temperature can be displayed in °C/Celsius or °F/Fahrenheit.

The factory default setting is °C/Celsius.

Display brightness

You can set the display brightness to one of seven different levels on the bar chart.

Volume

A buzzer sequence will sound at the end of a programme or if there is a fault as long as the buzzers are activated.

Buzzer in the event of a fault

In the event of a fault, the alarm tone will sound four times at intervals with a short pause between each set of tones.

The alarm tone that sounds when there is a fault cannot be deactivated.

Buzzers

The buzzer at the end of a programme will sound four times at intervals with a short pause between each set of tones.

The volume of the buzzer at the end of the programme can be selected from one of seven levels. If no volume is selected, the buzzer is switched off.

Keypad tone

An audible tone sounds each time a sensor control outside of the touch display is pressed.

The volume for the keypad tone can be set to one of seven different levels. If no volume is selected, the keypad tone is switched off (except the  *On/Off* sensor control).

Welcome melody

If you switch the dishwasher on or off, a brief melody will sound.

You can switch the melody off.

Refill reminders

If you only ever use combination detergent products or automatic dispensing using Miele PowerDisks (if available), you can switch off the refill reminders for dishwasher salt and rinse aid if you wish.

Please make sure that if you stop using combination detergents, you refill the dishwasher salt and rinse aid. Switch the refill reminders back on.

Settings

AutoOpen

In some programmes the door automatically opens slightly to assist the drying process.

This function can be deactivated if you wish.



Risk of damage due to steam. Steam from the dishwasher could damage the edges of delicate work-tops when you open the door at the end of the programme if the fan is no longer running.

If you have deactivated the automatic door opening function but would still like to open the door at the end of the programme, then make sure that you open the door fully.

Knock2open

You can choose whether the door should open after 1 or 2 knocks.

The function can be deactivated, in which case the door has to be fitted with a handle to open it.

BrilliantLight

This dishwasher is equipped with wash cabinet interior lighting.

When the door is open, the lighting switches off automatically after 15 minutes.

You can also switch off the wash cabinet interior lighting permanently.

Hygiene cycle

If you mainly use low temperature programmes (< 50 °C), there is a risk of bacteria and unpleasant odours building up in the wash cabinet (see “Cleaning and care” chapter, “Hygiene cycle” section).

To prevent this, the dishwasher will automatically increase the temperature in the final rinse of the selected programme after several low-temperature programmes have been run if this programme is selected. This is to prevent the build-up of residues and odours.

This programme results in higher energy consumption.

Heat accumulator

This dishwasher is equipped with a heat accumulator (see “Caring for the environment” chapter, “EcoTech heat accumulator” section).

Select State

The heat accumulator function can be switched off if you do not wish to use it.

- Select the *State* menu option.
- Select the setting you want and confirm with *OK*.

Empty manually

You can manually empty the heat accumulator, e.g. for a longer period of absence, or before moving the appliance to a new location.

- In doing so, please ensure that the dishwasher is properly connected.
- Select the *Empty manually* menu option.

The process starts straight away.

Software version

You can call up the electronic software version of your dishwasher for technical support purposes.

Legal information

You can view legal information about the open source licences for your dishwasher.

Showroom

For demonstration purposes only.

The dishwasher is equipped with a demo mode for showroom use.

Factory default

You can reset all the dishwasher settings and its network configuration to the factory default settings.

WiFi module settings (where applicable) have to be reset separately.

Appliance settings

You can use this menu option to reset all dishwasher settings, except WiFi module settings, to the factory default settings.

Network configuration

You can use this menu option to reset all WiFi module settings to the factory default settings.



United Kingdom

Miele Co. Ltd.
Fairacres, Marcham Road
Abingdon, Oxon, OX14 1TW
Tel: 0330 160 6600
Internet: www.miele.com

Australia

Miele Australia Pty. Ltd.
ACN 005 635 398
ABN 96 005 635 398
1 Gilbert Park Drive
Knoxfield, VIC 3180
Tel: 1300 464 353
Internet: www.miele.com.au

China

Miele (Shanghai) Trading Ltd.
1-3 Floor, No. 82 Shi Men Yi Road
Jing' an District
200040 Shanghai, PRC
Tel: +86 21 6157 3500
Fax: +86 21 6157 3511
E-mail: info@miele.cn
Internet: www.miele.cn

Miele (Hong Kong) Limited

41/F - 4101, Manhattan Place
23 Wang Tai Road
Kowloon Bay, Hong Kong
Tel: (852) 2610 1025
Fax: (852) 3579 1404
Email:
customerservices@miele.com.hk
Website: www.miele.hk

India

Miele India Pvt. Ltd.
Ground Floor
Copia Corporate Suites
Plot No. 9, Jasola
New Delhi - 110025
Tel: 011-46 900 000
Fax: 011-46 900 001
E-mail: customercare@miele.in
Internet: www.miele.in

Ireland

Miele Ireland Ltd.
2024 Bianconi Avenue
Citywest Business Campus
Dublin 24
Tel: (01) 461 07 10
Fax: (01) 461 07 97
E-Mail: info@miele.ie
Internet: www.miele.ie

Malaysia

Miele Sdn Bhd
Suite 12-2, Level 12
Menara Sapura Kencana
Petroleum
Solaris Dutamas No. 1
Jalan Dutamas 1
50480 Kuala Lumpur, Malaysia
Phone: +603-6209-0288
Fax: +603-6205-3768

New Zealand

Miele New Zealand Limited
IRD 98 463 631
Level 2, 10 College Hill
Freemans Bay, Auckland 1011
New Zealand
Tel: 0800 464 353
Internet: www.miele.co.nz

Singapore

Miele Pte. Ltd.
163 Penang Road
04 - 03 Winsland House II
Singapore 238463
Tel: +65 6735 1191
Fax: +65 6735 1161
E-Mail: info@miele.com.sg
Internet: www.miele.sg

South Africa

Miele (Pty) Ltd
63 Peter Place, Bryanston 2194
P.O. Box 69434, Bryanston 2021
Tel: (011) 875 9000
Fax: (011) 875 9035
E-mail: info@miele.co.za
Internet: www.miele.co.za

Taiwan

K.E. & Kingstone Co., Ltd.
6th Fl., No. 120, Sec. 2
Jianguo N. Rd.
Taipei, Taiwan
TEL: +886 2 2502-7256
FAX: +886 2 2502-3077
E-mail: kenk@kenk.com.tw
Website:
www.kenk.com.tw/ke/miele

Thailand

BHIRAJ TOWER at EmQuartier
43rd Floor Unit 4301-4303
689 Sukhumvit Road
North Klongton Sub-District
Vadhana District
Bangkok 10110, Thailand

United Arab Emirates

Miele Appliances Ltd.
Gold & Diamond Park
Office No. 6-217
Sheikh Zayed Road
P.O. Box 11 47 82 - Dubai
Tel. +971 4 3044 999
Fax. +971 4 3418 852
800-MIELE (64353)
E-Mail: info@miele.ae
Website: www.miele.ae

Manufacturer: Miele & Cie. KG, Carl-Miele-Straße 29, 33332 Gütersloh, Germany

G 7960, G 7965

en-GB

M.-Nr. 11 200 140 / 00