

## Operating and installation instructions Induction hobs



To avoid the risk of accidents or damage to the appliance it is **essential** to read these instructions before it is installed and used for the first time.

# Contents

---

<b>Warning and Safety instructions</b> .....	5
<b>Caring for the environment</b> .....	15
<b>Guide to the appliance</b> .....	16
Hob.....	16
Controls and display .....	17
<b>Before using for the first time</b> .....	18
Cleaning the hob for the first time .....	18
Switching on the hob for the first time .....	18
Miele@home .....	19
Setting up Miele@home .....	20
Cancelling the process.....	21
Resetting settings.....	21
Con@ctivity.....	22
Setting up Con@ctivity .....	22
Cancelling the process.....	24
Resetting settings.....	24
<b>Induction</b> .....	25
How it works.....	25
Pans.....	25
Noises.....	27
<b>Tips on saving energy</b> .....	28
<b>Setting ranges</b> .....	29
<b>Operation</b> .....	30
Using the appliance.....	30
Positioning cookware .....	31
Switching on the hob .....	32
Setting the power level.....	32
Switching the hob off .....	32
Residual heat indicator.....	32
Power level setting - Extended setting range.....	32
Auto heat-up .....	33
Booster .....	34
Keeping warm .....	35
<b>Timer</b> .....	36
Minute minder .....	36
Switch off automatically .....	37

---

<b>Additional functions</b> .....	38
Stop & Go .....	38
Recall .....	38
Wipe protection .....	39
Demonstration/showroom mode .....	39
Displaying hob data .....	40
<b>Safety features</b> .....	41
System lock/safety lock .....	41
Safety switch-off .....	42
Overheating protection .....	43
<b>Programming</b> .....	44
<b>Note for test institutes</b> .....	47
<b>Cleaning and care</b> .....	48
<b>Problem solving guide</b> .....	50
<b>Optional accessories</b> .....	54
<b>After sales service</b> .....	55
Contact in case of malfunction .....	55
Data plate .....	55
Warranty .....	55
<b>Installation</b> .....	56
Safety instructions for installation .....	56
Safety distances .....	57
Installation notes .....	61
Surface-mounted installation .....	61
Flush-fit installation .....	62
Installation dimensions – Surface-mounted .....	63
KM 7667 FR .....	63
KM 7667 FL, KM 7867 FL .....	64
KM 7677 FR .....	65
KM 7677 FL .....	66
Surface-mounted installation .....	67
Installation dimensions – Flush .....	68
KM 7617 FX .....	68
KM 7667 FL, KM 7867 FL .....	69
KM 7677 FL .....	70
Flush-fit installation .....	71
Electrical connection .....	72

# Contents

---

<b>Product data sheets .....</b>	<b>75</b>
<b>Conformity declaration .....</b>	<b>77</b>

## Warning and Safety instructions

---

This hob complies with all relevant local and national safety requirements. Inappropriate use can, however, lead to personal injury and material damage.

Read the operating and installation instructions carefully before using the hob. They contain important information on safety, installation, use and maintenance. This prevents both personal injury and damage to the hob.

In accordance with standard IEC 60335-1, Miele expressly and strongly advises that you read and follow the instructions in the chapter on installing the hob as well as the safety instructions and warnings.

Miele cannot be held liable for injury or damage caused by non-compliance with these instructions.

Keep these instructions in a safe place and pass them on to any future owner.

# Warning and Safety instructions

---

## Correct application

- ▶ This hob is intended for domestic use and use in other similar environments.
- ▶ This hob is not intended for outdoor use.
- ▶ It is intended for domestic use only to cook food and keep it warm. Any other use is not supported by the manufacturer and could be dangerous.
- ▶ This hob is not intended for use by people with reduced physical, sensory or mental capabilities or lack of experience and knowledge, unless they have been given supervision and instruction concerning its use by a person responsible for their safety. They may only use the hob unsupervised if they have been shown how to use it in a safe way. They must be able to recognise and understand the dangers of misuse.

### Safety with children

- ▶ Children under 8 years of age must be kept away from the hob unless they are constantly supervised.
- ▶ Children over 8 years of age may use the hob without supervision if its operation has been clearly explained to them and they are able to use it safely. Children must be able to understand and recognise the possible dangers caused by incorrect operation.
- ▶ Children must not be allowed to clean the hob unsupervised.
- ▶ Please supervise children in the vicinity of the hob and do not let them play with it.
- ▶ The hob gets hot when in use and remains hot for a while after being switched off. Keep children well away from the hob until it has cooled down and there is no danger of burning.
- ▶ Danger of burning! Do not store anything which might arouse a child's interest in storage areas above or behind the hob. Otherwise they could be tempted into climbing onto the appliance with the risk of burning themselves.
- ▶ Risk of burning and scalding. Place pots and pans on the cooking zone in such a way that children cannot pull them down and burn themselves.
- ▶ Danger of suffocation! Whilst playing, children may become entangled in packaging material (such as plastic wrapping) or pull it over their head with the risk of suffocation. Keep packaging material away from children.
- ▶ Activate the system lock to ensure that children cannot switch on the hob inadvertently. Use the safety lock when the hob is in use to prevent children from altering the settings selected.

# Warning and Safety instructions

---

## Technical safety

- ▶ Unauthorised installation, maintenance and repairs can cause considerable danger for the user. Installation, maintenance and repairs must only be carried out by a Miele authorised technician.
- ▶ Damage to the hob can compromise your safety. Check the hob for visible signs of damage. Do not use the hob if it is damaged.
- ▶ Reliable and safe operation of this hob can only be assured if it has been connected to the mains electricity supply.
- ▶ The hob must not be connected to the inverter of an autonomous power supply such as e.g. **a solar power system**. When the hob is switched on, power surges could result in a safety switch-off. This could damage the electronic module.
- ▶ The electrical safety of this hob can only be guaranteed when correctly earthed. It is essential that this standard safety requirement is met. If in any doubt please have the electrical installation tested by a qualified electrician.
- ▶ To avoid the risk of damage to the hob, make sure that the connection data on the data plate (voltage and frequency) match the mains electricity supply before connecting it to the mains. Consult a qualified electrician if in doubt.
- ▶ Do not connect the hob to the mains electrical supply by a multi-socket adapter or extension lead. These are a fire hazard and do not guarantee the required safety of the appliance.
- ▶ For safety reasons, this hob may only be used after it has been built in.
- ▶ This hob must not be used in a non-stationary location (e.g. on a ship).



## Warning and Safety instructions

---

- ▶ Never open the casing of the hob.

Touching or tampering with electrical connections or components and mechanical parts is highly dangerous to the user and can cause operational faults.

- ▶ While the hob is under warranty, repairs should only be undertaken by a Miele authorised service technician. Otherwise the warranty is invalidated.

- ▶ Miele can only guarantee the safety of the appliance when genuine original Miele replacement parts are used. Faulty components must only be replaced by Miele spare parts.

- ▶ The hob is not intended for use with an external timer switch or a remote control system.

- ▶ The hob must be connected to the electricity supply by a qualified electrician (see “Installation – Electrical connection”).

- ▶ If the mains connection cable is damaged, it must be replaced with a special mains connection cable by a qualified electrician (see “Electrical connection” in the “Installation” chapter).

- ▶ The hob must be disconnected from the mains electricity supply during installation, maintenance and repair work. Ensure that power is not supplied to the appliance until after it has been installed or until any maintenance or repair work has been carried out.

- ▶ Danger of electric shock. Do not use the hob if it is faulty, or if the ceramic surface is cracked, chipped or damaged in any way. Switch it off immediately. Disconnect the hob from the mains electricity supply. Contact Miele Service.

- ▶ If the hob is installed behind a cabinet door, do not close the door while the hob is in use. Heat and moisture can build up behind the closed door. This can result in damage to the hob, the housing unit and the floor. Do not close the door until the residual heat indicators go out.

## Warning and Safety instructions

---

► In areas which may be subject to infestation by cockroaches or other vermin, pay particular attention to keeping the appliance and its surroundings clean at all times. Any damage caused by cockroaches or other vermin will not be covered by the warranty.

### Correct use

- ▶ The hob gets hot when in use and remains hot for a while after being switched off. There is a danger of burning until the residual heat indicators go out.
- ▶ Oil and fat can overheat and catch fire. Do not leave the hob unattended when cooking with oil and fat. If it does ignite do not attempt to put the flames out with water.  
Disconnect the hob from the mains and use a suitable fire blanket, saucepan lid, damp towel or similar to smother the flames.
- ▶ Do not leave the hob unattended whilst it is being used. It should be continually monitored whilst boiling and flash frying.
- ▶ Flames could set the grease filters of a cooker hood on fire. Do not flambé under a cooker hood.
- ▶ Spray canisters, aerosols and other inflammable substances can ignite when heated. Therefore do not store such items or substances in a drawer under the hob. Cutlery inserts must be heat-resistant.
- ▶ Do not heat an empty pan.
- ▶ Do not heat up food in closed containers e.g. tins or sealed jars on the hob, as pressure can build up in the container, causing it to explode.
- ▶ Do not cover the hob, e.g. with a hob cover, a cloth or protective foil. The material could catch fire, shatter or melt if the hob is switched on by mistake or if residual heat is still present.
- ▶ When the appliance is switched on either deliberately or by mistake, or when there is residual heat present, there is the risk of metal items placed on the hob heating up. Other materials can melt or catch fire. Damp pan lids might adhere to the ceramic surface and be difficult to dislodge. Do not use the hob as a resting place for anything. Switch the hob off after use.

## Warning and Safety instructions

---

- ▶ You could burn yourself on the hot hob. Protect your hands with heat-resistant pot holders or gloves when handling hot pots and pans. Do not let them get wet or damp, as this causes heat to transfer through the material more quickly with the risk of scalding or burning yourself.
- ▶ When using an electrical appliance, e.g. a hand-held food blender, near the hob, ensure that the cable of the electrical appliance cannot come into contact with the hot hob. The insulation on the cable could become damaged.
- ▶ Grains of salt, sugar and sand (e.g. from cleaning vegetables) can cause scratches if they get under pan bases. Make sure that the ceramic surface is clean before placing pans on it.
- ▶ Even a light object can cause damage in certain circumstances. Do not drop anything on the ceramic surface.
- ▶ Placing hot pans on the sensors and indicators could damage the electronics underneath. Do not place hot pans on the sensors or indicators.
- ▶ Do not allow solid or liquid sugar, or pieces of plastic or aluminium foil to get onto the hob when it is hot, as they can damage the ceramic surface when it cools down. If this should occur, switch off the appliance and scrape off all the sugar, plastic or aluminium residues whilst still hot, using a shielded scraper blade suitable for use on glass. Wear oven gloves when doing this. Allow the ceramic surface to cool down and then clean it with a suitable ceramic hob cleaning agent.
- ▶ Pans which boil dry can cause damage to the ceramic glass. Do not leave the hob unattended whilst it is being used.
- ▶ Only use pots and pans with smooth bases. Rough bases will scratch the ceramic glass.
- ▶ Lift pans into position on the hob. Sliding them into place can cause scuffs and scratches.

## Warning and Safety instructions

---

- ▶ Because induction heating works so quickly, the base of the pan could, under certain circumstances, heat up to the temperature at which oil or fat self-ignites within a very short time. Never leave the hob unattended during use!
- ▶ Heat oil or fat for a maximum of one minute. Never use the Booster function to heat oil or fat.
- ▶ For people fitted with a heart pacemaker: Please note that the area immediately surrounding the hob is electromagnetically charged. It is very unlikely to affect a pacemaker. However, if in any doubt, consult the manufacturer of the pacemaker or your doctor.
- ▶ To prevent damage to items which are susceptible to electromagnetic fields, e.g. credit cards, digital storage devices, pocket calculators, etc, do not leave them in the immediate vicinity of the hob.
- ▶ Metal utensils stored in a drawer under the hob can become hot if the appliance is used intensively for a long time.
- ▶ The hob is fitted with a cooling fan. If a drawer is fitted directly underneath the hob, ensure that there is sufficient space between the drawer and its contents and the underside of the hob in order to ensure sufficient ventilation for the hob.
- ▶ If a drawer is fitted directly underneath the hob, do not store any pointed or small items, paper, serviettes, etc. in the drawer. They could get in through the ventilation slots or be sucked into the casing by the fan and damage the fan or impair cooling.

## Warning and Safety instructions

---

### Cleaning and care

- ▶ Do not use a steam cleaning appliance to clean this hob. The steam could reach electrical components and cause a short circuit.
- ▶ If the hob is built in over a pyrolytic oven, the hob should not be used whilst the pyrolytic process is being carried out, as this could trigger the overheating protection mechanism on the hob (see relevant section).

### Disposal of the packing material

The packaging is designed to protect the appliance from damage during transportation. The packaging materials used are selected from materials which are environmentally friendly for disposal and should be recycled.

Recycling the packaging reduces the use of raw materials in the manufacturing process and also reduces the amount of waste in landfill sites.

### Disposing of your old appliance

Electrical and electronic appliances often contain valuable materials. They also contain specific materials, compounds and components, which were essential for their correct function and safety. These could be hazardous to human health and to the environment if disposed of with your domestic waste or if handled incorrectly. Please do not, therefore, dispose of your old appliance with your household waste.



Please dispose of it at your local community waste collection / recycling centre for electrical and electronic appliances, or contact your dealer or Miele for advice. You are also responsible for deleting any personal data that may be stored on the appliance being disposed of. Please ensure that your old appliance poses no risk to children while being stored prior to disposal.

# Guide to the appliance

---

## Hob

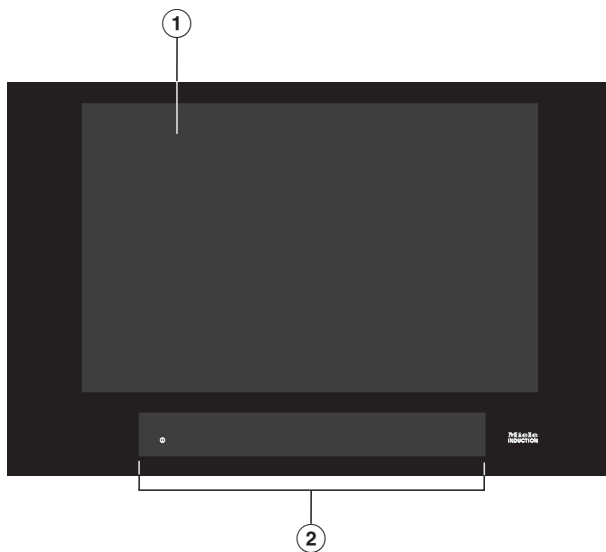
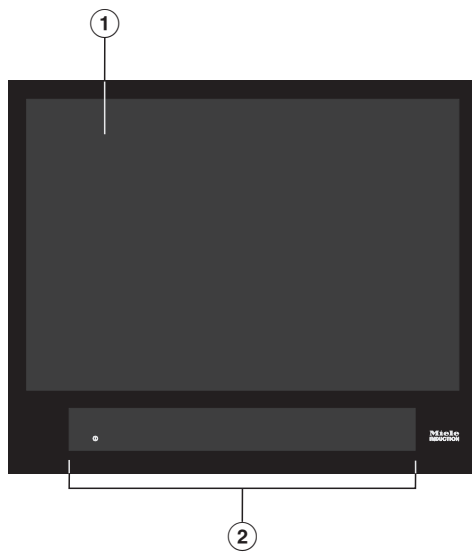

- ① Useable surface of the hob for a maximum of 4 pans
- ② Controls and indicators



## Controls and display

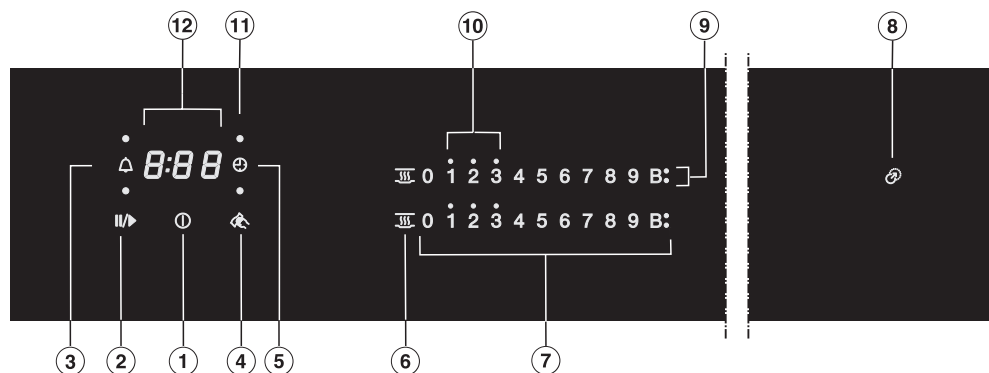

### Sensor controls

- ① For switching the hob on and off
- ② Stop & Go
- ③ Minute minder
- ④ Wipe protection
- ⑤ Switch off automatically
- ⑥ Keeping warm function
- ⑦ Numerical keybank
  - For setting the power level
  - For setting the timer

### Display / Indicator lights

- ⑧ Positioning aid
- ⑨ Booster activated
- ⑩ Residual heat
- ⑪ Pan assignment automatic switch-off
- ⑫ Timer display

*0:00* to     Time  
*9:59*

*LOC*             System lock/safety lock activated

*dE*                Demonstration mode activated

## Before using for the first time

---

- Please stick the extra data plate for the appliance supplied with this documentation in the space provided in the “After sales service” section of this booklet.
- Remove any protective wrapping and stickers.

### Cleaning the hob for the first time

- Before using for the first time, clean the hob with a damp cloth only and then wipe dry.

### Switching on the hob for the first time

The metal components have a protective coating which may give off a slight smell when heated up for the first time. The induction coils may also give off a slight smell for the first few hours of operation. This smell will be less noticeable with each subsequent use before dissipating completely.

The smell and any vapours given off do not indicate a faulty connection or appliance and they are not hazardous to health.

Please note that the heating up time on induction hobs is very much shorter than on conventional hobs.

# Before using for the first time

## Miele@home

Pre-requisite: Home WiFi network

Your hob is equipped with an integrated WiFi module. The hob can be connected to the household WiFi network.

If your Miele cooker hood is also connected to the home WiFi network, you can control the cooker hood automatically with the Con@ctivity function. Further information can be found in the installation and operating instructions for your cooker hood.

Make sure that the signal of your WiFi network is sufficiently strong in the place where your hob is installed.

There are a number of ways of connecting your hob to your WiFi network.

### Availability of the WiFi connection

The WiFi connection shares a frequency range with other appliances (including microwave ovens and remote control toys). This can give rise to sporadic or even complete connection failures. Therefore, the availability of featured functions cannot be guaranteed.

## Miele@home availability

The ability to use the Miele@mobile app depends on the availability of the Miele@home service in your country.

The Miele@home service is not available in every country.

For information about availability, please visit [www.miele.com](http://www.miele.com).

## Miele@mobile App

The Miele@mobile App is available to download free of charge from the Apple App Store® or from the Google Play Store™.



After installing the Miele@mobile App on a mobile device, you can do the following:

- Call up information on the operating status of your appliance
- Call up information on the programme sequence of your appliance
- Set up a Miele@home network with other Wi-Fi enabled Miele appliances

# Before using for the first time

## Setting up Miele@home

### Connecting via the app

The Miele@mobile app can be used to connect to your network.

- Install the Miele@mobile app on your mobile device.

To connect, you will need:

1. your WiFi network password
2. the password for your hob

The password for your hob consists of the last 9 digits of the serial number. This can be found on the appliance's data plate.

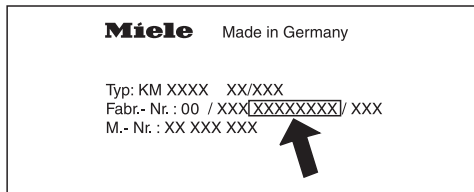

- Switch the hob on.
- Place an induction-compatible pan on the hob.
- Start the Miele@mobile app.
- Touch and hold the 0 and 5 sensor controls on the numerical display at the same time for 6 seconds.

The seconds can be seen counting down in the timer display. After the time has elapsed, the code  $\text{C:}01$  is displayed in the timer display for 10 seconds.

You now have 10 minutes to configure the WiFi.

- Follow the instructions in the app.

## Connecting via WPS

**Prerequisite:** you must have a WPS (WiFi protected setup) compatible router.

- Switch the hob on.
- Place an induction-compatible pan on the hob.
- Touch and hold the 0 and 6 sensor controls on the numerical display at the same time for 6 seconds.

The seconds can be seen counting down in the timer display. After the 6 seconds have elapsed, a progress light appears during the connection attempt (for max. 120 seconds).

The WPS login is only active during these 120 seconds.

- Activate the WPS function on your WiFi router.

If the connection was successful, the code  $\text{C:}02$  appears in the timer display. If the connection could not be established, the timer display will show the code  $\text{C:}01$ . You have probably not activated WPS on your router quickly enough. Repeat the steps above.

**Tip:** If your WiFi router does not support WPS, please connect via the Miele@mobile app.

## Canceling the process

- Touch any sensor control.

## Resetting settings

Resetting is not required when replacing the router.

- Switch the hob on.
- Place an induction-compatible pan on the hob.
- Touch and hold the 0 and 9 sensor controls on the numerical display at the same time for 6 seconds.

The seconds can be seen counting down in the timer display. After the time has elapsed, the code `∞:00` is displayed in the timer display for 10 seconds.

Reset the settings if you are disposing of your hob, selling it or putting a used hob into operation. This is the only way to ensure that all personal data has been removed and the previous owner will no longer be able to access the hob.

# Before using for the first time

---

## Con@ctivity

Con@ctivity is the direct communication system between an electric Miele hob and a Miele cooker hood. Con@ctivity enables the cooker hood to operate automatically depending on the operational state of a hob.

Further information can be found in the installation and operating instructions for your cooker hood.

### Availability of the WiFi connection

The WiFi connection shares a frequency range with other appliances (including microwave ovens and remote control toys). This can give rise to sporadic or even complete connection failures. Therefore, the availability of featured functions cannot be guaranteed.

## Setting up Con@ctivity

### Con@ctivity via the home WiFi network (Con@ctivity 3.0)

Prerequisite:

- Home WiFi network
- WiFi-enabled Miele cooker hood

- Connect the cooker hood and the hob to your home WiFi network (see “Initial commissioning – Miele@home”).

The Con@ctivity function will be activated automatically.

## Before using for the first time

### Con@ctivity via a direct WiFi connection (Con@ctivity 3.0)

Prerequisite: WiFi-enabled Miele cooker hood

If you do not have a home network, you can establish a direct connection between the hob and the cooker hood.

- Switch the cooker hood off.
- Press and hold the + (**B**\*) control.
- Press the – (**1**\*) control at the same time.

\* Cooker hoods with sensor controls.

**2** will light up constantly, and **3** will flash on and off.

The cooker hood is ready for connection for the next two minutes.

- Switch the hob on.
- Place an induction-compatible pan on the hob.
- Touch and hold the 0 and 7 sensor controls on the numerical display at the same time for 6 seconds.

The seconds can be seen counting down in the timer display. After the time has elapsed, a progress light appears during the connection attempt. If the connection was successful, the code `C:D2` appears in the timer display. If the connection could not be established, the timer display will show the code `C:D1`. Repeat the steps above.

When successfully connected, **2** and **3** will light up constantly on the cooker hood.

- Quit connection mode on the cooker hood by pressing the run-on control <sup>5</sup>  <sup>15</sup>.

Con@ctivity is now activated.

With a direct WiFi connection, it is not possible to connect the hob and the cooker hood to a home network. If this is desired later, the direct WiFi connection between the hob and the cooker hood must first be reset (see “Initial commissioning – Con@ctivity” and “Disconnecting the WiFi” in the operating and installation instructions for the cooker hood).

# Before using for the first time

---

## Canceling the process

- Touch any sensor control.

## Resetting settings

Resetting is not required when replacing the router.

- Switch the hob on.
- Place an induction-compatible pan on the hob.
- Touch and hold the 0 and 9 sensor controls on the numerical display at the same time for 6 seconds.

The seconds can be seen counting down in the timer display. After the time has elapsed, the code `∞:00` is displayed in the timer display for 10 seconds.

Reset the settings if you are disposing of your hob, selling it or putting a used hob into operation. This is the only way to ensure that all personal data has been removed and the previous owner will no longer be able to access the hob.



## How it works

Induction coils are located under the ceramic surface. These coils create a magnetic field that reacts directly with the base of the pan and heats it up. The ceramic surface itself is heated up indirectly by the heat given off by the pan.

The position, size and shape of the pots and pans are recognised automatically by the induction hob.

An induction cooking zone only works when a pan with a magnetic base is placed on it (see “Pans”).

The pan base material and the positions of the pans on the hob affect the power of the induction coils. This can affect the cooking behaviour.



Risk of burning due to hot items. When the appliance is switched on either deliberately or by mistake, or when there is residual heat present, there is the risk of metal items placed on the hob heating up.

Do not use the appliance as a resting place for anything.

After use, switch the hob off with the  sensor control.

## Pans

### Pan size

**Round** pans should preferably have a base diameter from 145 mm up to a maximum of 350 mm. Pans with a base diameter between 100 mm and 145 mm will not be detected in every position on the hob.

**Oval/square** pans must not exceed dimensions of 380 mm x 300 mm.

### Suitable pans

- stainless steel pans with a magnetic base
- enamelled steel pans
- cast iron pans

Please be aware that the properties of the pan base can affect the evenness with which the food heats up (e.g. when making pancakes). The base of the pan must be able to distribute the heat evenly. A sandwich base made of stainless steel is particularly suitable.

# Induction

---

## Unsuitable pans.

- stainless steel pans without a magnetic base
- aluminium or copper pans
- glass, ceramic or earthenware pots and pans

## Testing pans

To test whether a pan is induction-compatible, hold a magnet to the base of the pan. If the magnet sticks, the pan is generally suitable.

## Unsuitable pan indicator

When the hob is switched on and you place a pan on a cooking zone but the corresponding number display does not appear:

- the diameter of the base of the pan is too small or
- the pan is unsuitable

## Tips

- Use only pans with smooth bases. Rough pan bases can scratch the ceramic glass.
- Always lift pans to move them. This will help prevent scratching. If any scratches do appear as a result of pans being pushed around, this will not affect the function of the hob. These scratches are normal signs of use and are not grounds for making a complaint.
- Please note that the maximum diameter quoted by manufacturers often refers to the diameter of the top rim of the pan. The diameter of the base (generally smaller) is more important.



- Where possible, use pans with vertically straight sides. If a pan has angular sides, induction also acts on the sides of the pan. The sides of the pan may discolour or the coating may peel off.

## Noises

The following noises can occur in the pan, depending on what it is made of and how it has been constructed:

Buzzing on the higher power settings. This will decrease or cease altogether when the power setting is reduced.

If the pan base is made of layers of different materials (e.g. in a sandwiched base), it might emit a crackling sound.

You might hear a clicking sound from the electronic switches, especially on lower settings.

A whirring sound, when the cooling fan comes on. This switches on to protect the electronics when the hob is being used intensively. The fan may continue to run after the appliance has been switched off.

## Tips on saving energy

---

- Use a lid whenever possible to minimise heat loss.
- Select a smaller pan when cooking small quantities. A smaller pan uses less energy than a larger pan with very little in it.
- Cook with as little water as possible.
- Once food has come to the boil or the oil in the pan is hot enough for frying, reduce the heat to a lower setting.
- Use a pressure cooker to reduce cooking times.

## Setting ranges

The hob is programmed with 9 power levels at the factory. If you wish to fine-tune a setting, you can extend the power level range to 17 power levels (see “Programming”).

	Setting range	
	Factory setting (9 power levels)	Extended setting (17 power levels)
Melting butter Melting chocolate Dissolving gelatine	1–2	1–2.
Warming up small quantities of liquid Keeping warm food which sticks easily Cooking rice or porridge Defrosting vegetables frozen in a block	2–4	2–3.
Warming up liquid and semi-solid food Steaming fruit Simmering potatoes (pans with lids)	4–6	3.–5.
Making omelettes or lightly fried eggs Gently frying meat patties Steaming fish and vegetables Cooking dumplings and dried pulses Defrosting and reheating frozen food Thickening sauces, e.g. Hollandaise	5–7	4.–7.
Gently frying fish, escalopes, sausages, fried eggs (without overheating the fat)	6–8	6–7.
Cooking potato fritters, pancakes, etc.	7–8	7–8.
Boiling large quantities of water Bringing to the boil Flash frying large amounts of meat	9	8.–9

These settings should only be taken as a guide. The power of the induction coils will vary depending on the pan base size and material and the positions of the pans on the hob. For this reason, it is possible that the power levels will need to be adjusted slightly to suit your pans. As you use the hob, you will get to know which settings suit your pans best. When using new pans that you are not familiar with, set the power level below the one specified.

# Operation

## Using the appliance

This ceramic hob is equipped with electronic sensor controls which react to finger contact. For safety reasons, in order to switch the appliance on, the On/Off ① sensor needs to be touched for a little longer than the other sensors. Each time a sensor control is activated, an audible signal sounds.

Only the printed On/Off ① symbol is visible when the hob is switched off. More sensors light up when the hob is switched on.

 Malfunction due to dirty and/or covered sensor controls.

If the sensor controls are dirty or covered this could cause them to fail to react, to activate a function or even to switch the appliance off automatically (see “Safety features”, “Safety switch-off”). Placing hot pans on the sensor controls/indicators can damage the electronic unit underneath.

Keep the sensor controls and indicators clean.

Do not place anything over the sensor control or indicators.

Do not place hot pans over the sensor controls or indicators.



①

① Sensor controls and indicators

## Positioning cookware

You can use a maximum of 4 pans at the same time on this hob.

### Tips

- You can position the pans anywhere on the useable surface of the hob.
- We recommend switching the hob on first and then placing the pans on it. If you do this, the pans will be detected more quickly by the hob.
- If you are using several pans at once, position them as far apart as possible. This will enable the hob to recognise each of them individually.
- Move pans on the hob one after the other, not all at the same time.
- When you move a pan on the hob, the associated numerical keybank lights up. The set power level “goes along” with it.
- Pans with a base diameter between 100 and 145 mm will not be detected in every position on the hob.

## Possible faults

You place a pan on the hob and the associated numerical keybank does not appear.

The pan cannot be detected in this position because it is very small.

- Re-position the pan. If it is still not detected, use a different pan.

There are several pans on the hob. You place another pan on the hob and the  symbol lights up.

The pans are too close together.

- Re-position the pans.

Move pans on the hob one after the other, not all at the same time.

You re-position a pan and the set power level starts to flash.

The pan cannot be detected.

- Touch the flashing power level.
- If the power level continues to flash, re-position the pan.

You re-position a pan, the set power level goes out and **0** lights up.

- Reset the power level.

# Operation

 Risk of fire with overheated food. Unattended food can overheat and catch alight. Do not leave the hob unattended whilst it is being used.

Please note that the heating up time on induction hobs is very much shorter than on conventional hobs.

## Switching on the hob

- Touch the ① sensor.

Other sensors will light up.

If no further entry is made, the hob will switch itself off after a few seconds for safety reasons.

## Setting the power level

- Place the pans in the required position on the hob.

The corresponding numerical keybank lights up.

- Touch the appropriate sensor control on the numerical keybank for the power level you want.

If you do not set a power level within approx. 10 seconds, the numerical keybank will go out.

## Switching the hob off

- Touch the ① sensor control.

## Residual heat indicator

If the an area of the ceramic surface is hot, the residual heat indicator will light up after the hob has been switched off. Depending on the temperature, a dot will appear above power levels 1, 2 and 3.

The dots of the residual heat indicator go out one after the other as the ceramic surface cools down. The last dot only goes out when the ceramic surface is safe to touch.

 Risk of burning due to hot ceramic surface. The ceramic surface will be hot after use. Do not touch the ceramic surface while the residual heat indicators are on.

## Power level setting - Extended setting range

- Touch the numerical keybank in between two number sensors.

The numbers to the left and right of the interim level light up brighter than the others.

Example:

If you have set power level 7. the numbers 7 and 8 will be brighter than the other numbers.



## Auto heat-up

When Auto heat-up has been activated, the cooking zone switches on automatically at the highest setting and then switches to the continued cooking setting which you have previously selected. The heat-up time depends on which continued cooking setting has been chosen (see chart).

### Activating Auto heat-up

- Touch the sensor for the continued cooking setting you want until a tone sounds and the sensor starts to pulsate.

During the heat-up time (see chart), the continued cooking level set will pulsate. With extended power levels (see “Programming”), the sensors for the power levels in front of and after the interim power level will pulsate if an extended power level setting has been selected.

Altering the continued cooking setting will deactivate Auto heat-up.

### Deactivating Auto heat-up

- Touch the sensor for the continued cooking setting.
- or
- Set another power level.

Continued cooking setting*	Heat-up time [min : sec]
1	Approx. 0:15
1.	Approx. 0:15
2	Approx. 0:15
2.	Approx. 0:15
3	Approx. 0:25
3.	Approx. 0:25
4	Approx. 0:50
4.	Approx. 0:50
5	Approx. 2:00
5.	Approx. 5:50
6	Approx. 5:50
6.	Approx. 2:50
7	Approx. 2:50
7.	Approx. 2:50
8	Approx. 2:50
8.	Approx. 2:50
9	–

\* The continued cooking settings with a dot after the number are only available if the power level range has been extended (see “Programming”).

# Operation

---

## Booster

When activated, the power is boosted so that large quantities can be heated up quickly, e.g. when boiling water for cooking pasta. The boost in power is active for a maximum of 15 minutes.

You can use the Booster function for a maximum of 2 pans at the same time: 1 on the right-hand side of the hob and 1 on the left-hand side.

If the Booster function is switched on when

- no power level has been selected, the cooking zone will revert automatically to level 9 at the end of the Booster time or if the Booster function is switched off before this.
- a power level has been selected, the cooking zone will revert automatically to the power level selected at the end of the Booster time or if the Booster function is switched off before this.

While the Booster is in operation some of the power is taken away from the other induction coils. If another pan is in use on the same side of the hob, it will be affected as follows:

- Auto-heat-up is deactivated.
- The power level will be reduced.
- The linked cooking zone is switched off.

## Activating TwinBooster

### Level 1

- Place the pans in the required position on the hob.
- Select a power level if necessary.
- Touch the **B** sensor control.

The indicator ● for TwinBooster level 1 lights up.

### Level 2

- Place the pans in the required position on the hob.
- Select a power level if necessary.
- Touch the **B** sensor control twice.

The indicator ●● for TwinBooster level 2 lights up.

## Deactivating TwinBooster

- Touch the **B** sensor control repeatedly until the indicators go out.

or

- Set another power level.

## Keeping warm

This function is for keeping food warm which has just been cooked and is still hot. It is not for reheating food that has gone cold.

The maximum duration for keeping food warm is 2 hours.

- Only use pans for keeping food warm. Cover the pan with a lid.
- Stir firm or viscous food (mashed potatoes, stew) occasionally.
- Nutrients are lost when food is cooked, and continue to diminish when food is kept warm. The longer food is kept warm, the greater the loss of nutrients. Try to ensure that food is kept warm for as short a time as possible.

## Activating/deactivating the keeping warm function

- Touch the  sensor control on the corresponding numerical keybank.

## Keeping-warm temperatures

A keeping-warm temperature of 75 °C is set as standard. You can change the keeping-warm temperature (see “Programming”).

Use	Temperature °C
Melting chocolate	50–60
Keeping solid food and thick liquids warm	65–75
Keeping clear soups warm	80–90

The cooking result can be negatively affected if food is kept warm at excessively high temperatures. Food can change colour and even spoil.

# Timer

---

The hob has to be switched on if you want to use the timer.

A duration of between 1 minute (0:01) and 9 hours 59 minutes (9:59) can be set.

Durations of up to 59 minutes are shown in minutes (00:59) and durations of more than 60 minutes are shown in hours and minutes. Durations are entered in the order of hours, followed by minutes in tens and then units.

Example:

59 minutes = 00:59, touch: 5-9



80 min = 1:20, touch: 1-2-0

After the first number has been entered the timer display will light up constantly. After the second number has been entered, the first number will move to the left. After the third number has been entered, the first and second numbers will move to the left.

The timer can be used for the following two different functions:

- For setting the minute minder
- For automatically switching the hob off

The functions can be used at the same time. The shortest time is always displayed and the  sensor control (minute minder) or the indicator light for automatic switch-off pulsates.

Touch the  or  sensor control if you want to show the times remaining counting down in the background. If one switch-off time has been programmed for several pans, touch the  sensor control repeatedly until the indicator for the required pan pulsates.

## Minute minder

The minute minder is set using the numerical keybank for the left or front left cooking zone (depending on model).

### Setting the minute minder

- Touch the  sensor control.

The timer display starts flashing.

- Set the required time.

### Changing the minute minder duration

- Touch the  sensor control.

- Set the required time.

### Deleting the minute minder duration

- Touch the  sensor control repeatedly until 0:00 appears in the timer display.

## Switch off automatically

You can set a time after which the heat for a pan will switch off automatically. This function can be used for all pans at the same time.

The switch-off time is set on the numerical display for each pan you want to switch off automatically.

If the time programmed is longer than the maximum operating time allowed, the safety switch-off will switch off the cooking zone (see “Safety features – Safety switch-off”).

If you re-position a pan and reset the power level, the switch-off time will be deleted. You must then reset the switch-off time.

- Set a power level for the required pan.
- Touch the ⌚ sensor control.

The indicator light will start to flash.

- Set the required duration.
- If you want to set a switch-off time for other pans, follow the same steps as described above.

If more than one switch-off time is programmed, the shortest time remaining will be displayed, and the corresponding indicator light will flash. The other indicator lights will light up constantly.

- If you want to show the time remaining for another pan which is counting down in the background, touch

the ⌚ sensor control repeatedly until the indicator light for the pan you require flashes.

## Changing the switch-off time

- Touch the ⌚ sensor control repeatedly until the indicator light for the pan you require flashes.
- Set the required duration.

## Deleting the switch-off time

- Touch the ⌚ sensor control repeatedly until the indicator light for the pan you require flashes.
- Touch the 0 sensor control on the numerical display.

## Additional functions

---

### Stop & Go

When Stop & Go is activated, all power levels are reduced to 1.

The power levels and the timer settings cannot be altered; the hob can only be switched off. The minute minder, switch-off, Booster and AutoBoost times continue to run.

When the function is deactivated, the appliance switches back to the power level that was set last.

If the function is not deactivated within 1 hour, the hob will switch off.

### Activating/Deactivating

- Touch the II/▶ sensor control.

Use this function if there is a danger of food boiling over.

### Recall

If the hob is switched off by mistake during use, this function can be used to reset all settings. For this to work, the hob must be switched on again within 10 seconds of being switched off.

- Switch the hob on again.

The previously set power levels flash.

- Press one of the flashing power level indicators immediately.

All settings are restored.

## Wipe protection

The hob sensors can be locked for 20 s in order, for example, to remove soiling. The ① is not locked.

### Activating

- Touch the  sensor.

The time will count down in the timer display.

### Deactivating

- Touch the  sensor until the timer display goes out.

## Demonstration/showroom mode

These functions enable the hob to be demonstrated in showrooms without heating up.

### Activating/deactivating demonstration mode

When this mode is set, the hob can be operated as normal.

- Switch the hob on.
- Place an induction-compatible pan on the hob.
- Touch and hold the 0 and 2 sensor controls on the numerical display at the same time for 6 seconds.

In the timer display,  $dE$  flashes alternately with  $Dn$  (demonstration mode activated) or  $OFF$  (demonstration mode deactivated) for a few seconds.

### Activating/deactivating showroom mode

In showroom mode, cooking processes are simulated in an infinite loop. The sequence of the individual steps is repeated after 1 minute. When you touch a sensor control or place pans on the hob, it switches to demonstration mode.

- Switch the hob on.
- Place an induction-compatible pan on the hob.
- Touch and hold the 0 and 8 sensor controls on the numerical display at the same time for 6 seconds.

In the timer display,  $dE$  flashes alternately with  $Dn$  (showroom mode activated) or  $OFF$  (showroom mode deactivated) for a few seconds.

# Additional functions

---

## Displaying hob data

The model number and software version of the hob can be displayed.

### Model number/serial number

- Switch the hob on.
- Place an induction-compatible pan on the hob.
- Touch and hold the 0 and 4 sensor controls on the numerical display at the same time.

Numbers will appear in the timer display one after another, separated by a dash.

Example: *12 34* (model number KM 1234) – *1 23 45 67 89* (serial number)

### Software version

- Switch the hob on.
- Place an induction-compatible pan on the hob.
- Touch and hold the 0 and 3 sensor controls on the numerical display at the same time.

Numbers appear in the timer display:

Example: *2:00* = software version 2.00



## System lock/safety lock

Your hob is equipped with a system lock and a safety lock to prevent it being switched on or any settings being altered by mistake.

The **system lock** is activated when the hob is switched off. If the system lock is activated, the hob cannot be switched on and the timer cannot be used. A set minute minder time continues to count down. The hob is programmed so that the system lock must be activated manually. It can be programmed to be activated automatically 5 minutes after the hob has been switched off (see “Programming”).

The **safety lock** is activated when the hob is switched on. When the safety lock is activated, the hob can be operated only under certain conditions:

- The hob can only be switched off.
- Selected power levels **cannot** be changed.
- A set minute minder time can be modified.

If an unavailable sensor control is touched whilst the system lock or safety lock is activated *LDC* will appear in the timer display for a few seconds and a tone will sound.

## Activating the system lock

- Touch the  sensor for 6 seconds.



The seconds can be seen counting down in the timer display. When this time has elapsed *LDC* will appear in the timer display. The system lock has been activated.

## Deactivating the system lock

- Touch the  sensor for 6 seconds.



*LDC* will appear briefly in the timer display and then the seconds will be seen counting down. The system lock is deactivated once the time has elapsed.

## Activating the safety lock

- Touch and hold the  and  sensors at the same time for 6 seconds.

The seconds can be seen counting down in the timer display. When this time has elapsed *LDC* will appear in the timer display. The safety lock is activated.

## Deactivating the safety lock

- Touch and hold the  and  sensors at the same time for 6 seconds.

*LDC* will appear briefly in the timer display and then the seconds will be seen counting down. Once the time has elapsed, the lock function is deactivated.

# Safety features

## Safety switch-off

### Sensor controls are covered

Your hob will turn off automatically if one or several of the sensors remain covered for longer than 10 seconds, for example, by finger contact, food boiling over or by an object such as an oven glove or tea towel. ① flashes briefly above the  $\sqcup$  sensor control and a tone will sound.

$\sqcup$  will go out once you have removed the object and/or cleaned the hob and the hob will be ready to use again.

### Excessive operating time

The safety shut-off is triggered automatically if a zone is heated for an unusually long period of time. This time depends on the power level selected. If it has been exceeded, the heat switches off and the residual heat indicator appears. A power level can be selected in the usual way.

The hob is programmed to safety setting 0 at the factory. If necessary, a higher safety setting with a shorter maximum operating time can be set (see chart).

Power level*	Maximum operating time [h:min]		
	Safety setting		
	0**	1	2
1	10:00	8:00	5:00
1.	10:00	7:00	4:00
2/2.	5:00	4:00	3:00
3/3.	5:00	3:30	2:00
4/4.	4:00	2:00	1:30
5/5.	4:00	1:30	1:00
6/6.	4:00	1:00	0:30
7/7.	4:00	0:42	0:24
8	4:00	0:30	0:20
8.	4:00	0:30	0:18
9	1:00	0:24	0:10

\* The power levels with a dot after the number are only available if the power level range has been extended (see “Setting range”).

\*\* Factory default setting

### Overheating protection

All the induction coils and cooling elements for the electronics are fitted with an overheating protection mechanism. Before the induction coils and/or cooling elements get too hot, the overheating protection mechanism cuts in in one of the following ways:

#### Induction coils

- Any Booster function in operation will be switched off.
- The set power level will be reduced.
- The heat for a zone switches off automatically. *Err* flashes alternately with *044* in the timer display.

You can use the zone again as usual when the fault code has gone out.

#### Cooling elements

- Any Booster function in operation will be switched off.
- The set power level will be reduced.
- The heat switches off automatically.

The affected zones can only be used again as usual once the cooling element has cooled down to a safe level.

The overheating protection may be activated under the following circumstances:

- The pan being heated is empty.
- Fat or oil is being heated on a high power level.
- Insufficient ventilation to the underside of the hob.
- A hot zone being switched on after an interruption to the power supply.

If, despite removing the cause, the overheating protection mechanism triggers again, contact the Customer Service Department.

# Programming

---



You can adapt the programming of the hob to your personal needs. Several settings can be altered in succession.

After accessing programming mode, the  symbol appears and *P**ℓ* will appear in the timer display. After a few seconds *P:01* (Programme 01) will flash alternately with *ℓ:01* (Code) in the timer display.

## Change programming

### Accessing programming mode

The *II/▶* sensor is located approx. 1 cm (index finger width) to the left of the  sensor.

- **With the hob switched off**, touch the  and *II/▶* sensors at the same time until the  symbol and *P**ℓ* appear in the timer display.

### Setting a programme

For a two digit programme number you need to first set the tens position.

- Whilst the programme is visible in the display (e.g. *P:01*), touch the  sensor repeatedly until the number for the programme you want appears in the display or touch the appropriate number on the numerical keybank.

### Setting the code

- Whilst the code is visible in the display (e.g. *ℓ:01*), touch the  sensor repeatedly until the number for the code you want appears in the display or touch the appropriate number on the numerical keybank.

### To save the settings

- While the programme is showing in the display (e. g. *P:01*) touch the  sensor until the indicators go out.

### To avoid saving the settings

- While the code is showing in the display (e. g. *ℓ:01*) touch the  sensor until the indicators go out.

# Programming

Programme <sup>1)</sup>		Code <sup>2)</sup>	Settings
P:01	Demonstration/showroom mode	C:00	Demonstration mode off
		C:01	Demonstration mode on <sup>3)</sup>
		C:02	Showroom mode on <sup>3)</sup>
P:02	Power management <sup>4)</sup>	C:00	Off
		C:01	3680 W
		C:02	3000 W
		C:03	2000 W
		C:04	1000 W
P:03	Factory default setting	C:00	Factory default settings not restored
		C:01	Factory default settings restored
P:04	Number of power levels	C:00	9 power levels
		C:01	17 power levels <sup>5)</sup>
P:06	Audible tone when a sensor control is touched	C:00	Off <sup>6)</sup>
		C:01	Quiet
		C:02	Medium
		C:03	Loud
P:07	Buzzer for the timer	C:00	Off <sup>6)</sup>
		C:01	Quiet
		C:02	Medium
		C:03	Loud
P:08	System lock	C:00	System lock can only be activated manually
		C:01	System lock activated automatically
P:09	Maximum operating time	C:00	Safety setting 0
		C:01	Safety setting 1
		C:02	Safety setting 2

# Programming

Programme <sup>1)</sup>		Code <sup>2)</sup>	Settings
<b>P:10</b>	WiFi registration	<b>C:00</b>	Not active/deactivated
		C:01	Active but not configured
		C:02	Active and configured
		C:03	Connection possible via WPS push button
		C:04	WiFi reset to default (C:00)
		C:05	Direct WiFi connection between hob and cooker hood without app (Con@ctivity 3.0)
<b>P:12</b>	Sensor controls reaction speed	C:00	Slow
		<b>C:01</b>	Normal
		C:02	Fast
<b>P:14</b>	Confirmation of power level when position of pan is changed	C:00	Confirmation necessary
		<b>C:01</b>	Confirmation not necessary
<b>P:25</b>	Keeping-warm temperature	C:00	50 °C
		C:01	55 °C
		C:02	60 °C
		C:03	65 °C
		C:04	70 °C
		<b>C:05</b>	75 °C
		C:06	80 °C
		C:07	85 °C
		C:08	90 °C

1) Unlisted programmes are not assigned.

2) The factory setting is shown in bold.

3) After the hob has been switched on, *dE* appears in the timer display for a few seconds.

4) The total hob power may be reduced in order to meet the local network provider's requirements.

5) In the text and charts, the extended power levels are shown with a dot after the number for better understanding.

6) The keypad tone for the On/Off sensor control cannot be switched off.

### **Test food acc. to EN 60350-2**

9 power levels are programmed at the factory.

For testing in accordance with the above standard, programme the hob to the extended power level setting.

# Cleaning and care

---

 Danger of burning due to hot surfaces.

The ceramic surface will be hot after use.

Switch the hob off.

Allow the ceramic surface to cool down before cleaning the hob.

 Risk of damage due to moisture ingress.

The steam from a steam cleaning appliance could reach live electrical components and cause a short circuit.

Do not use a steam cleaner to clean the hob.

All surfaces could be discoloured or damaged if unsuitable cleaning agents are used. All surfaces are susceptible to scratching.

Remove all cleaning agent residues immediately.

Never use abrasive cleaning agents.

- Clean the hob after every use.
- Dry the hob thoroughly after cleaning with water to avoid limescale residue.

## Unsuitable cleaning agents

To avoid damaging the surfaces of the appliance, do not use:

- washing-up liquid
- cleaning agents containing soda, alkalines, ammonia, acids or chlorides
- cleaning agents containing descaling agents
- stain and rust removers
- abrasive cleaning agents, e.g. powder cleaners and cream cleaners
- solvent-based cleaning agents
- dishwasher cleaner
- oven sprays
- glass cleaning agents
- hard, abrasive brushes or sponges (e.g. pot scourers) or sponges which have been previously used and still contain abrasive cleaning agents
- melamine eraser blocks



## Cleaning the ceramic surface

 Risk of damage by pointed objects.

The seal between the hob and the worktop could suffer damage.

The seal between the ceramic surface and the frame could suffer damage.

Do not use pointed objects for cleaning.

Not all soiling and residues can be removed using a solution of washing-up liquid. An invisible film can develop that can lead to discolouration of the glass ceramic surface. This discolouration cannot be removed.

Clean the ceramic surface regularly with a proprietary ceramic glass cleaning agent.

- Remove any coarse soiling with a damp cloth and more stubborn soiling with a scraper suitable for use on glass.
- Then clean the ceramic glass surface with the Miele ceramic and stainless steel hob cleaner (see “Optional accessories”) or with a proprietary ceramic glass cleaner applied with kitchen paper or a clean cloth. Do not apply the cleaner while the hob is still hot, as this can result in marking. Please follow the cleaning agent manufacturer's instructions.
- Finally wipe the glass ceramic surface with a damp cloth and polish with a soft, dry cloth.

Residues can burn onto the hob the next time it is used and cause damage to the glass ceramic surface. Ensure that all cleaning agent residues are removed.

- **Spots** caused by limescale, water and aluminium residues (spots with a metallic appearance) can be removed using Miele's ceramic and stainless steel hob cleaner.

 Danger of burning due to hot surfaces.

The ceramic surface is hot during use.

Wear oven gloves when removing residues of sugar, plastic or aluminium foil from a hot ceramic surface with a scraper suitable for use on glass.

- Should any **sugar, plastic or aluminium foil** spill or fall onto the hot ceramic surface while it is in use, switch off the hob.
- Then carefully scrape off these residues **immediately** whilst they are still hot, using a scraper suitable for use on glass.
- Afterwards, clean the ceramic surface in its cooled state, as described above.

## Problem solving guide

---

Many malfunctions and faults that can occur in daily operation can be easily remedied. Time and money will be saved because a service call will not be needed.

The following guide may help you to find the reason for a malfunction or a fault, and to correct it.

Problem	Cause and remedy
<b>The hob cannot be switched on.</b>	<p>There is no power to the hob.</p> <ul style="list-style-type: none"><li>■ Check whether the fuse has tripped. Contact an electrician or Miele Service (for the minimum fuse rating, see data plate).</li></ul> <p>There may be a technical fault.</p> <ul style="list-style-type: none"><li>■ Disconnect the hob from the electricity supply for approx. 1 minute. To do this:<ul style="list-style-type: none"><li>– trip the relevant fuse or screw the fuse out completely, or</li><li>– switch off the residual current protection device</li></ul></li><li>■ If the appliance will still not turn on after resetting the trip switch in the fuse box or the residual current device, contact a qualified electrician or Miele Service.</li></ul>
<b>A smell and vapours are given off when the new appliance is being used.</b>	<p>The metal components have a protective coating. When the appliance is used for the first time, this causes a smell and possibly also vapour. The material from which the induction coils are made also gives off a smell in the first few hours of operation. With each subsequent use, the odour is reduced until it disappears completely. The smell and any vapours given off do not indicate a faulty connection or appliance and they are not hazardous to health.</p>
<b>After the hob has been switched on, or after touching a sensor, <i>LOC</i> appears in the timer display for a few seconds.</b>	<p>The system lock or safety lock is activated.</p> <ul style="list-style-type: none"><li>■ Deactivate the system lock or safety lock (see “System lock / Safety lock”).</li></ul>

## Problem solving guide

Problem	Cause and remedy
<b>The hob has switched off automatically. When the element is switched back on, <math>\text{E}</math> appears above the On/Off sensor control <math>\text{①}</math>.</b>	<p>One or more of the sensor controls are covered, e.g. by finger contact, food boiling over or an object.</p> <ul style="list-style-type: none"> <li>■ Clean off any dirt and/or remove the object (see “Safety features” – “Safety switch-off”).</li> </ul>
<b>After the hob has been switched on, <math>dE</math> appears in the timer display for a few seconds. The hob does not heat.</b>	<p>The hob is in demonstration mode.</p> <ul style="list-style-type: none"> <li>■ Touch the 0 sensor control on any of the numerical displays.</li> <li>■ Then touch the <math>\text{D}</math> and <math>\text{Z}</math> sensor controls at the same time until <math>dE</math> flashes alternately with <math>\text{OFF}</math> in the timer display.</li> </ul>
<b>When you place a pot or a pan on the hob the corresponding numerical keybank does not appear.</b>	<p>The pan cannot be detected in this position because it is very small.</p> <ul style="list-style-type: none"> <li>■ Re-position the pan. If it is still not detected, use a different pan.</li> </ul>
	<p>The pan is unsuitable.</p> <ul style="list-style-type: none"> <li>■ Use suitable pans (see “pans” in the “Induction” chapter).</li> </ul>
<b>The  symbol lights up.</b>	<p>The pans are too close together.</p> <ul style="list-style-type: none"> <li>■ Re-position the pans. Move the pans one after the other, not all at the same time.</li> </ul>
<b>You re-position a pan and the set power level starts to flash.</b>	<p>The pan cannot be detected.</p> <ul style="list-style-type: none"> <li>■ Touch the flashing power level.</li> <li>■ If the power level continues to flash, re-position the pan.</li> </ul>
<b>You re-position a pot or a pan, the set power level goes out and 0 lights up.</b>	<p>The pan cannot be detected.</p> <ul style="list-style-type: none"> <li>■ Reset the power level.</li> </ul>
<b>A zone switches itself off automatically.</b>	<p>It has been operated for too long.</p> <ul style="list-style-type: none"> <li>■ Switch a power level back on again (see “Safety switch off” in the “Safety features” chapter).</li> </ul>
<b>A zone or the whole hob switches off automatically.</b>	<p>The overheating protection mechanism has been activated.</p> <ul style="list-style-type: none"> <li>■ See “Overheating protection” in the “Safety features” chapter.</li> </ul>

## Problem solving guide

Problem	Cause and remedy
<b>The Booster has deactivated early automatically.</b>	<p>The overheating protection mechanism has been activated.</p> <ul style="list-style-type: none"> <li>■ See “Safety features”.</li> </ul>
<b>A zone is not working in the usual way on the power setting selected.</b>	<p>The overheating protection mechanism has been activated.</p> <ul style="list-style-type: none"> <li>■ See “Overheating protection” in the “Safety features” chapter.</li> </ul>
<b>In comparable cooking and frying processes there are slight differences in cooking durations and browning.</b>	<p>This is not a fault.</p> <p>The pan base material and the positions of the pans on the hob affect the power of the induction coils. This in turn affects the cooking behaviour.</p>
<b>The food in the pan does not heat up when the Auto heat-up function is switched on.</b>	<p>A large amount of food is being heated up.</p> <ul style="list-style-type: none"> <li>■ Start cooking at the highest power level and then turn down to a lower one manually later on.</li> </ul>
	<p>The pan is not conducting heat properly.</p> <ul style="list-style-type: none"> <li>■ Use a different pot or pan which conducts heat properly.</li> </ul>
<b>An operating noise can be heard after the appliance has been switched off.</b>	<p>The cooling fan runs until the hob has cooled down and then switches off automatically.</p>
<b><i>Err</i> alternating with 30 flashes in the timer display and a buzzer sounds.</b>	<p>The hob is incorrectly connected.</p> <ul style="list-style-type: none"> <li>■ Disconnect the hob from the mains electricity supply.</li> <li>■ Call Miele Service. The hob must be connected to the mains according to the wiring diagram.</li> </ul>

## Problem solving guide

Problem	Cause and remedy
<p><b>“E” and a number, e.g. E-0, is flashing alternately with a 3-digit number in the timer display.</b></p>	<p>Numbers <i>120–125</i> The fan is blocked or defective.</p> <ul style="list-style-type: none"> <li>■ Make sure it has not been blocked by an object.</li> <li>■ Remove the obstruction.</li> <li>■ If this fault code continues to appear in the display, contact the Customer Service Department.</li> </ul> <p>Other numbers Fault in a zone</p> <ul style="list-style-type: none"> <li>■ Disconnect the power supply to the hob for approx. 1 minute.</li> <li>■ If the problem persists after power has been restored, please contact the Customer Service Department.</li> </ul>
<p><b><i>Err</i> flashes alternately with numbers in the timer display.</b></p>	<p><i>Err044</i> The overheating protection mechanism has been activated.</p> <ul style="list-style-type: none"> <li>■ See “Safety features – Overheating protection”.</li> </ul> <p><i>Err</i> and other numbers There is a fault in the electronic module.</p> <ul style="list-style-type: none"> <li>■ Disconnect the power supply to the hob for approx. 1 minute.</li> <li>■ If the problem persists after power has been restored, please contact the Customer Service Department.</li> </ul>

## Optional accessories

---

Miele offer a comprehensive range of useful accessories as well as cleaning and conditioning products for your Miele appliances.

These products can be ordered through the Miele Webshop.

They can also be ordered from Miele (see end of this booklet for contact details) or from your Miele dealer.

### Pans

Miele offer a wide range of pans which are perfect for Miele hobs. Please refer to the Miele website for more details on individual products.

- Pans in various sizes
- Frying pan with lid
- Anti-stick pans
- Wok
- Gourmet oven dishes

### Cleaning and care products

#### Ceramic and stainless steel hob cleaner 250 ml



Removes heavy soiling, limescale deposits and aluminium residues

#### Microfibre cloth

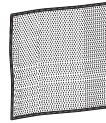

Removes finger marks and light soiling

### Contact in case of malfunction

In the event of any faults which you cannot remedy yourself, please contact your Miele Dealer or Miele Service.

Contact information for Miele Service can be found at the end of this document.

Please note that telephone calls may be monitored and recorded for training purposes and that a call-out charge will be applied to service visits where the problem could have been resolved as described in this booklet.

Please quote the model and serial number of your appliance when contacting Miele. This information can be found on the data plate.

### Data plate

Stick the extra data plate supplied with the appliance here. Make sure that the model number matches the one specified on the back cover of this document.



### Warranty

For information on the appliance warranty specific to your country please contact Miele. See back cover for address.

In the UK, your appliance warranty is valid for 2 years from the date of purchase. However, you must activate your cover by calling 0330 160 6640 or registering online at [www.miele.co.uk](http://www.miele.co.uk).

# Installation

---

## Safety instructions for installation

 **Damage risk from incorrect installation.**  
Incorrect installation can cause damage to the hob.  
The hob must only be installed by a qualified person.

 **Risk of electric shock.**  
Incorrect connection to the mains supply may result in an electric shock.  
The hob must be connected to the electrical supply by a qualified person only.

 **Damage from falling objects.**  
Take care not to damage the hob when fitting wall units or a cooker hood above it.  
Fit the wall units and the cooker hood before the hob.

- ▶ The veneer or laminate coatings of worktops (or adjacent kitchen units) must be treated with 100 °C heat-resistant adhesive which will not dissolve or distort. Any backmoulds must be of heat-resistant material.
- ▶ The hob must not be installed over a fridge, fridge-freezer, freezer, dishwasher, washing machine, washer-dryer or tumble dryer.
- ▶ This hob must not be installed above ovens or cookers unless these have a built-in cooling down fan.
- ▶ After installation, ensure that nothing can come into contact with the connection cable and that it is without hindrance.
- ▶ The electrical cable may not come into contact with any moving kitchen component (e.g. a drawer) or be subject to mechanical obstruction which could damage it.
- ▶ Observe carefully the safety clearances listed on the following pages.



## Safety distances

### Safety distance above the hob

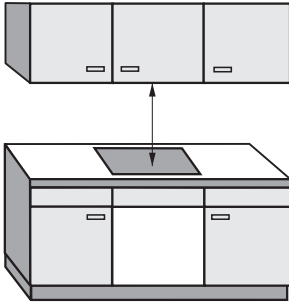

The safety distance specified by the manufacturer of the cooker hood must be maintained between the hob and the cooker hood above it.

If combustible objects are installed above the hob (e.g., cabinets, utensil rail, etc.), a minimum safety distance of 600 mm must be maintained.

When two or more appliances which have different safety distances are installed together below a cooker hood, you should observe the greatest specified safety distance.

# Installation

## Safety distances to the sides and back of the hob

It is advisable to install the hob with plenty of space either side of it.

The minimum distance ① shown below must be maintained between the back of the hob and a tall unit or wall.

The minimum distance ②, ③ shown below must be maintained between a tall unit or a wall to the left or right of the hob with a minimum distance of 300 mm on the opposite side.

① Minimum distance between the **back** of the worktop cut-out and the rear edge of the worktop:  
50 mm

② Minimum distance between the worktop cut-out and a wall or tall unit to the **right** of it:  
50 mm.

③ Minimum distance between the worktop cut-out and a wall or tall unit to the **left** of it:  
50 mm.

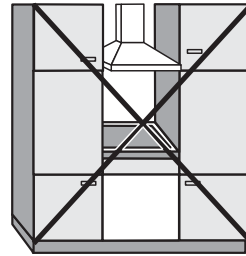

Not allowed

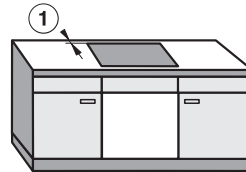
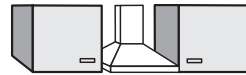

Highly recommended

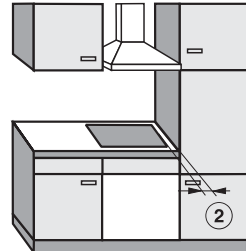

Not recommended

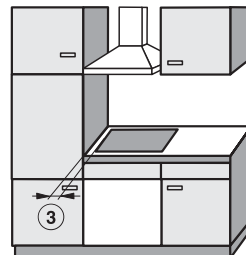

Not recommended

## Minimum safety distance underneath the hob

To ensure sufficient ventilation to the hob, a minimum distance must be left between the underside of the hob and any oven, intermediate shelf or drawer.

The minimum gap between the underside of the hob and

- Upper edge of oven: 2 mm
- Upper edge of intermediate shelf: 2 mm
- Upper edge of drawer: 5 mm
- Base of drawer: 75 mm

## Intermediate shelf

It is not necessary to fit an intermediate shelf underneath the hob, but one may be fitted if you wish.

Leave a gap of 10 mm at the back between the cabinet and the intermediate shelf to **accommodate the power cable**.

A gap of 20 mm is recommended at the front between the cabinet and intermediate shelf for better **ventilation** of the hob.

# Installation

## Safety distance when installing the appliance near a wall with additional niche cladding

A minimum safety distance must be maintained between the worktop cut-out and any niche cladding to protect it from heat damage.

If the niche cladding is made from a combustible material (e.g. wood) a minimum safety distance ⑤ of 50 mm must be maintained between the cut-out and the cladding.

If the niche cladding is made from a non-combustible material (e.g. metal, natural stone, ceramic tiles) the minimum safety distance ⑤ between the cut-out and the cladding will be 50 mm less the thickness of the cladding.

Example: 15 mm niche cladding

50 mm - 15 mm = minimum safety distance of 35 mm

### Flush-fitted hobs

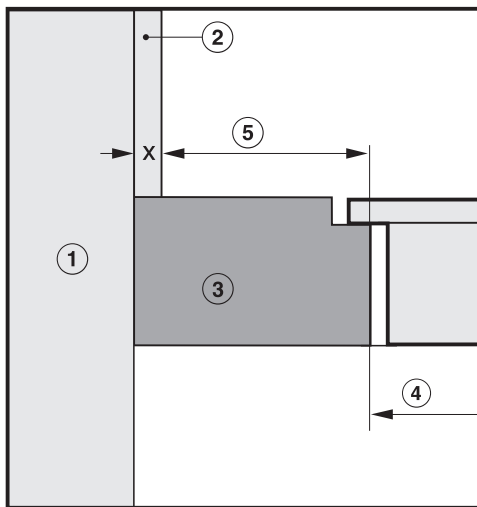

### Hob with frame or bevelled edge

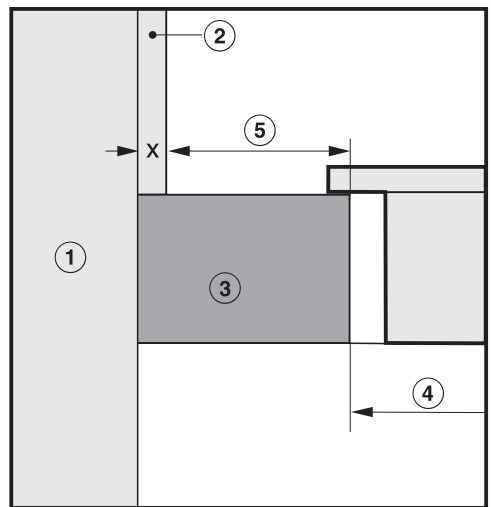

- ① Masonry
- ② Niche cladding dimension  $x$  = thickness of the niche cladding material
- ③ Worktop
- ④ Worktop cut-out
- ⑤ Minimum distance to  
**combustible** materials 50 mm  
**non-combustible** materials 50 mm - dimension  $x$

## Installation notes

### Surface-mounted installation

#### Seal between the hob and the worktop

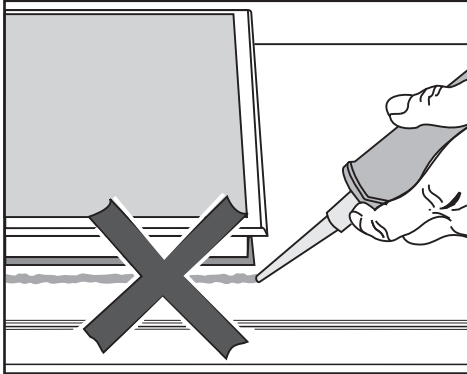

 **Damage caused by incorrect installation.**

Using sealant under the hob could result in damage to the hob and the worktop if the hob ever needs to be removed for servicing.

Do not use sealant between the hob and the worktop.

The sealing strip under the edge of the hob provides a sufficient seal for the worktop.

### Tiled worktops

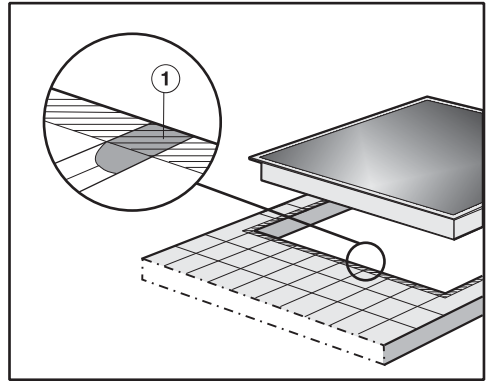

Grout lines ① and the hatched area underneath the hob frame must be smooth and even. If they are not the hob will not sit flush with the worktop and the sealing strip underneath the hob will not provide a good seal between the hob and the worktop.

# Installation

---

## Flush-fit installation

Flush-fit installation is only possible in natural stone (granite, marble), solid wood and tiled worktops. Certain models are suitable for building into glass worktops – please see the relevant label on the hob. When using a worktop made from any other material, please check first with the worktop manufacturer that it is suitable for installing a flush-fit hob.

The internal width of the base unit underneath the appliance must be at least as wide as the inner worktop cut-out (see “Installation – Building-in dimensions – flush fit”), so that the hob is easily accessible from underneath after installation and the bottom half of the casing can be removed for maintenance. If the underside of the hob is not freely accessible after installation, any sealant used to plug the gaps around the appliance must be removed to enable the hob to be lifted out of the cut-out should this be necessary.

## Natural stone worktops

The hob is set directly in the cut-out.

## Solid wood worktops, tiled worktops, glass worktops

The hob is secured inside the cut-out with wooden battens. The battens must be provided on site, and are not supplied with the appliance.

## Sealing strip

Dismantling the hob for service purposes may damage the sealing strip underneath the edge of the hob.

Always replace the sealing strip before reinstalling the hob.

## Installation dimensions – Surface-mounted

All dimensions are given in mm.

### KM 7667 FR

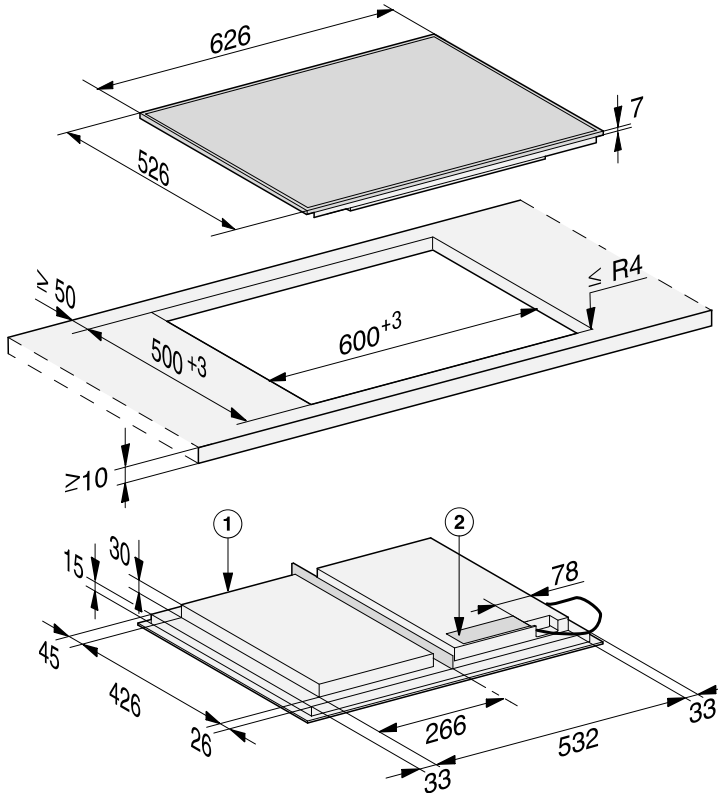

① Front

② Mains connection box

The mains connection cable (L = 1440 mm) is supplied loose

# Installation

KM 7667 FL, KM 7867 FL

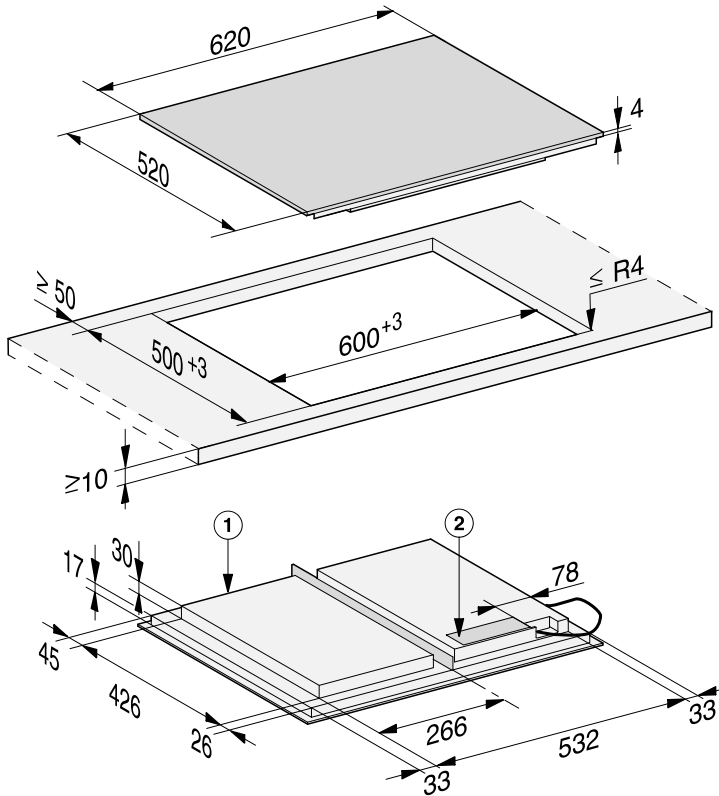

① Front

② Mains connection box

The mains connection cable (L = 1440 mm) is supplied loose



## KM 7677 FR

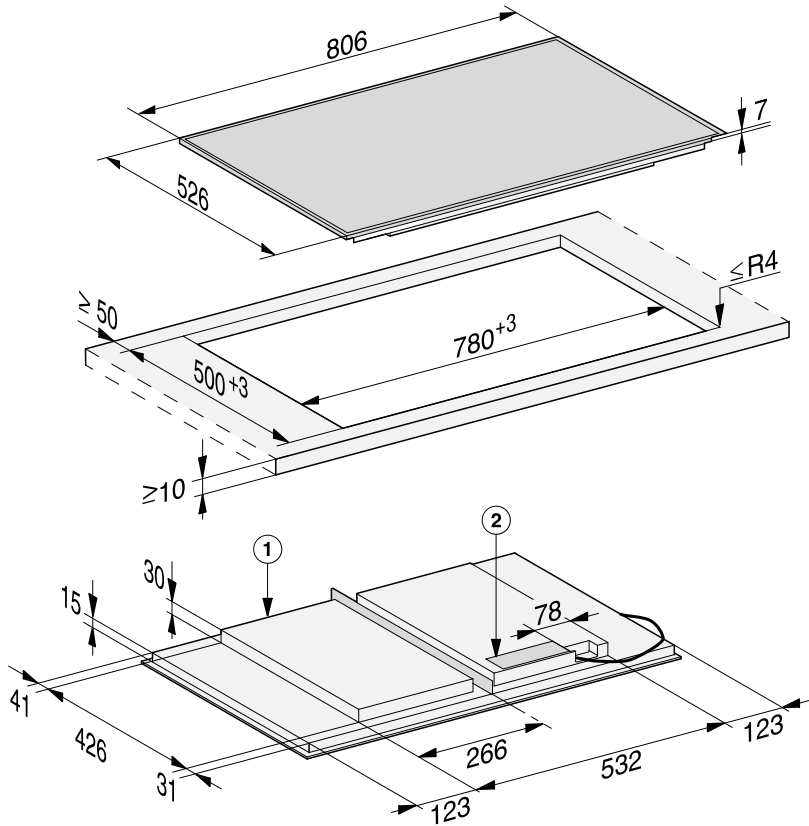

① Front

② Mains connection box

The mains connection cable (L = 1440 mm) is supplied loose

# Installation

## KM 7677 FL

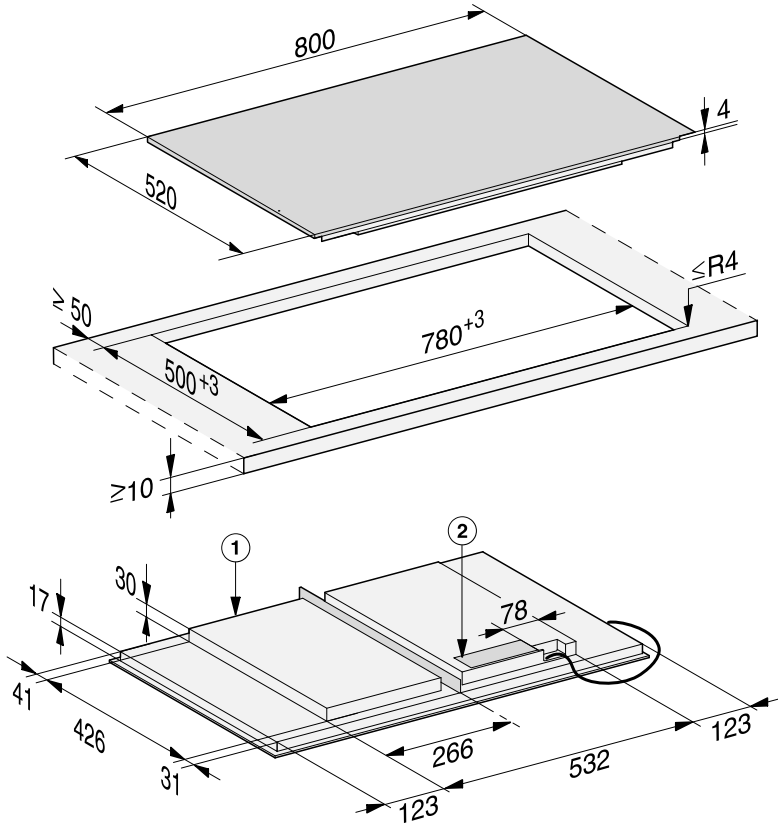

① Front

② Mains connection box

The mains connection cable (L = 1440 mm) is supplied loose

## Surface-mounted installation

- Create the worktop cut-out. Remember to maintain the minimum safety distances (see “Installation – Safety distances”).
- Seal any cut surfaces on **wooden worktops** with a special varnish, silicone sealant or resin to prevent the wood from swelling as a result of moisture ingress. The sealant must be heat-resistant.

Make sure that the sealant does not come into contact with the top of the worktop.

- Stick the supplied sealing strip under the edge of the hob. Do not apply the sealing strip under tension.

 Risk of damage from incorrect connection.

The hob electronics may be damaged if a short-circuit occurs.

The power cable must be connected to the hob by a qualified electrician.

- Connect the power cable by following the instructions in the wiring diagram on the hob (see “Installation – Electrical connection”).
- Feed the power cable for the hob down through the worktop cut-out.
- Place the hob centrally in the cut-out. When doing this, make sure that the seal of the appliance sits flush with the worktop on all sides. This is important to ensure an effective seal all round.

If the seal does not sit flush with the worktop in the corners, the corner radius ( $\leq R4$ ) can be carefully cut to fit using a jigsaw.

- Connect the hob to the electricity supply (see “Installation – Electrical connection”).
- Check that the hob works.



## KM 7667 FL, KM 7867 FL

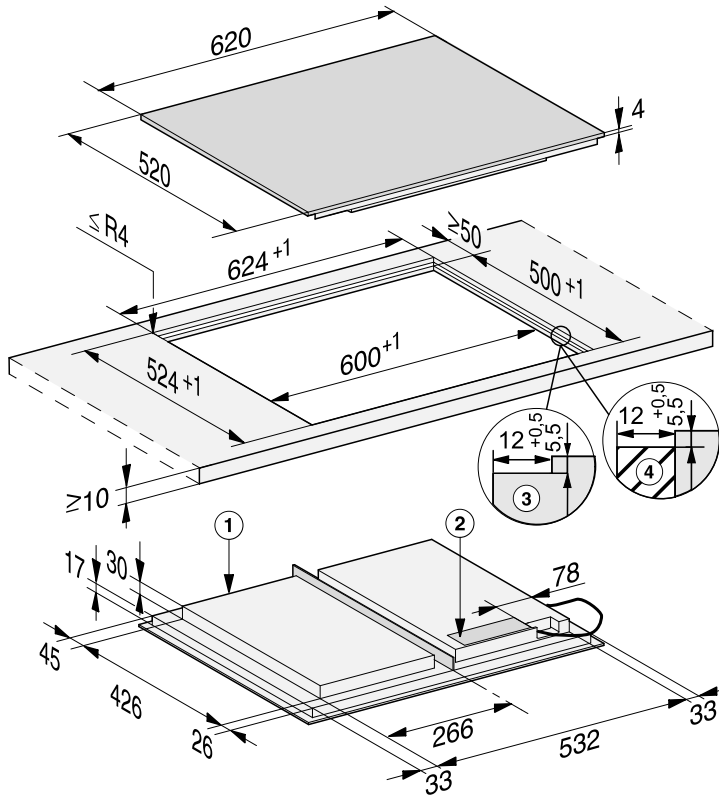

- ① Front
- ② Mains connection box  
The mains connection cable (L = 1440 mm) is supplied loose
- ③ Stepped cut-out, natural stone worktop
- ④ Wooden batten 12 mm (not supplied)



## Flush-fit installation

- Create the worktop cut-out. Remember to maintain the minimum safety distances (see “Installation – Safety distances”).
- Solid wood, tiled and glass worktops: Fix a wooden frame 5,5 mm below the top edge of the worktop.

 Risk of damage from incorrect connection.

The hob electronics may be damaged if a short-circuit occurs.

The power cable must be connected to the hob by a qualified electrician.

- Connect the power cable by following the instructions in the wiring diagram on the hob (see “Installation – Electrical connection”).
- Stick the supplied sealing strip under the edge of the hob. Do not apply the sealing strip under tension.
- Feed the power cable for the hob down through the worktop cut-out.
- Centre the hob in the cut-out.

The gap between the ceramic surface and the worktop must be at least 2 mm wide. This is required so that the hob can be sealed.

- Connect the hob to the electricity supply (see “Installation – Electrical connection”).
- Check that the hob works.
- Seal the gap between the hob and worktop with a silicone sealant that is heat-resistant to at least 160 °C.

 Damage from unsuitable sealant. Unsuitable sealant can damage natural stone.

For natural stone worktops and natural stone tiles, only use silicone sealant that is specially formulated for natural stone. Follow the manufacturer’s instructions.

# Installation

---

## Electrical connection

 Risk of damage from incorrect connection.

Unauthorised installation, maintenance and repairs can cause considerable danger for the user.

Miele cannot be held liable for damage or injury caused by unauthorised installation, maintenance or repair work, or by an inadequate or faulty on-site earthing system (e.g. electric shock).

This hob must be connected to the electrical supply by a qualified electrician.

The electrician must be familiar with and comply with the national regulations and any additional regulations of the local electricity provider (e.g. BS 7671 in the UK).

After installation, ensure that all electrical components are shielded and cannot be accessed by users.

## Total power rating

See data plate

## Connection data

The connection data is quoted on the data plate. Please ensure these match the household mains supply.

Please see wiring diagrams for connection. (N.B. This appliance is supplied single phase only in the UK / AUS / NZ).

## Residual current device

For extra safety, it is advisable to protect the appliance with a suitable residual current device (RCD) with a trip range of 30 mA.

## WARNING

**THIS APPLIANCE MUST BE EARTHED**

## Disconnecting devices

It must be possible to disconnect the hob from the mains at all poles using disconnecting devices! A contact distance of at least 3 mm must be observed in the switched-off state! The disconnecting devices are overcurrent protection devices and residual current protection devices.



## Disconnecting from the mains

 Risk of electric shock.

There is a risk of electric shock if the appliance is connected to the mains supply during repair or service work. After disconnection, ensure the appliance cannot be switched back on by mistake.

To disconnect the appliance from the mains power supply, do one of the following depending on installation:

### Safety fuses

- Completely remove fuses.

### Automatic circuit breakers

- Press the (red) test button until the middle (black) button springs out.

### Built-in circuit breakers

- Circuit breakers at least type B or C:  
Switch the lever from 1 (on) to 0 (off).

### Residual current device (RCD)

- Switch the main switch from 1 (on) to 0 (off) or press the test button.

## Mains connection cable

The hob must be connected to the electrical supply with a special connection cable, type H 05 VV-F (PVC insulated) with a suitable diameter.

Please see wiring diagram for connection. (N.B. This appliance is supplied single phase only in the UK / AUS / NZ).

See the data plate on the hob for the correct voltage and frequency.

## Replacing the mains connection cable

 Risk of electric shock.

Incorrect connection to the power supply may result in an electric shock.

The mains cable must only be replaced by a qualified electrician.

When replacing the mains cable only use cable type H 05 VV-F with a suitable cross section. A suitable connection cable is available to order from Miele.

# Installation

## Wiring diagram

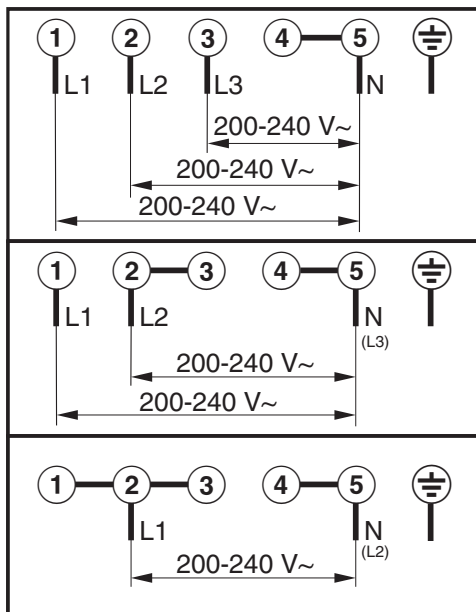

The following data sheets apply to the models described in this operating instruction manual.

## Information for domestic electric hobs

In acc. with regulation (EU) No. 66/2014

<b>MIELE</b>	
<b>Model name/identifier</b>	KM 7617
Number of cooking zones and/or areas	
For circular cooking zones: diameter of useful surface area/cooking zone For non-circular cooking zones or areas: length and width of useful surface area per electric cooking zone or area	1. = 573x376 mm 2. = 3. = 4. = 5. = 6. =
Energy consumption per cooking zone or area calculated per kg (EC <sub>electric cooking</sub> )	-
Energy consumption for the hob calculated per kg (EC <sub>electric hob</sub> )	188,5 Wh/kg

## Information for domestic electric hobs

In acc. with regulation (EU) No. 66/2014

<b>MIELE</b>	
<b>Model name/identifier</b>	KM 7667
Number of cooking zones and/or areas	
For circular cooking zones: diameter of useful surface area/cooking zone For non-circular cooking zones or areas: length and width of useful surface area per electric cooking zone or area	1. = 573x386 mm 2. = 3. = 4. = 5. = 6. =
Energy consumption per cooking zone or area calculated per kg (EC <sub>electric cooking</sub> )	-
Energy consumption for the hob calculated per kg (EC <sub>electric hob</sub> )	188,5 Wh/kg

# Product data sheets

## Information for domestic electric hobs

In acc. with regulation (EU) No. 66/2014

MIELE	
Model name/identifier	KM 7677
Number of cooking zones and/or areas	
For circular cooking zones: diameter of useful surface area/cooking zone For non-circular cooking zones or areas: length and width of useful surface area per electric cooking zone or area	1. = 603x381,5 mm 2. = 3. = 4. = 5. = 6. =
Energy consumption per cooking zone or area calculated per kg (EC <sub>electric cooking</sub> )	-
Energy consumption for the hob calculated per kg (EC <sub>electric hob</sub> )	188,5 Wh/kg

## Information for domestic electric hobs

In acc. with regulation (EU) No. 66/2014

MIELE	
Model name/identifier	KM 7867
Number of cooking zones and/or areas	
For circular cooking zones: diameter of useful surface area/cooking zone For non-circular cooking zones or areas: length and width of useful surface area per electric cooking zone or area	1. = 573x386 mm 2. = 3. = 4. = 5. = 6. =
Energy consumption per cooking zone or area calculated per kg (EC <sub>electric cooking</sub> )	-
Energy consumption for the hob calculated per kg (EC <sub>electric hob</sub> )	188,5 Wh/kg

## Conformity declaration

---

Miele hereby declares that this ceramic induction hob complies with Directive 2014/53/EU.

The complete text of the EU declaration of conformity is available from one of the following internet addresses:

- Products, Download from [www.miele.co.uk](http://www.miele.co.uk)
- For service, information, operating instructions etc: go to [www.miele.co.uk/domestic/customer-information-385.htm](http://www.miele.co.uk/domestic/customer-information-385.htm) and enter the name of the product or the serial number

Frequency band of the WiFi module	2.4000 GHz – 2.4835 GHz
-----------------------------------	-------------------------

Maximum transmitting power of the WiFi module	< 100 mW
---	----------





## United Kingdom

Miele Co. Ltd.  
Fairacres, Marcham Road  
Abingdon, Oxon, OX14 1TW  
Tel: 0330 160 6600  
Internet: [www.miele.com](http://www.miele.com)

## Australia

Miele Australia Pty. Ltd.  
ACN 005 635 398  
ABN 96 005 635 398  
1 Gilbert Park Drive  
Knoxfield, VIC 3180  
Tel: 1300 464 353  
Internet: [www.miele.com.au](http://www.miele.com.au)

## China

Miele (Shanghai) Trading Ltd.  
1-3 Floor, No. 82 Shi Men Yi Road  
Jing' an District  
200040 Shanghai, PRC  
Tel: +86 21 6157 3500  
Fax: +86 21 6157 3511  
E-mail: [info@miele.cn](mailto:info@miele.cn)  
Internet: [www.miele.cn](http://www.miele.cn)

## Miele (Hong Kong) Limited

41/F - 4101, Manhattan Place  
23 Wang Tai Road  
Kowloon Bay, Hong Kong  
Tel: (852) 2610 1025  
Fax: (852) 3579 1404  
Email:  
[customerservices@miele.com.hk](mailto:customerservices@miele.com.hk)  
Website: [www.miele.hk](http://www.miele.hk)

## India

Miele India Pvt. Ltd.  
Ground Floor  
Copia Corporate Suites  
Plot No. 9, Jasola  
New Delhi - 110025  
Tel: 011-46 900 000  
Fax: 011-46 900 001  
E-mail: [customercare@miele.in](mailto:customercare@miele.in)  
Internet: [www.miele.in](http://www.miele.in)

## Ireland

Miele Ireland Ltd.  
2024 Bianconi Avenue  
Citywest Business Campus  
Dublin 24  
Tel: (01) 461 07 10  
Fax: (01) 461 07 97  
E-Mail: [info@miele.ie](mailto:info@miele.ie)  
Internet: [www.miele.ie](http://www.miele.ie)

## Malaysia

Miele Sdn Bhd  
Suite 12-2, Level 12  
Menara Sapura Kencana  
Petroleum  
Solaris Dutamas No. 1  
Jalan Dutamas 1  
50480 Kuala Lumpur, Malaysia  
Phone: +603-6209-0288  
Fax: +603-6205-3768

## New Zealand

Miele New Zealand Limited  
IRD 98 463 631  
Level 2, 10 College Hill  
Freemans Bay, Auckland 1011  
New Zealand  
Tel: 0800 464 353  
Internet: [www.miele.co.nz](http://www.miele.co.nz)

## Singapore

Miele Pte. Ltd.  
163 Penang Road  
# 04 - 03 Winsland House II  
Singapore 238463  
Tel: +65 6735 1191  
Fax: +65 6735 1161  
E-Mail: [info@miele.com.sg](mailto:info@miele.com.sg)  
Internet: [www.miele.sg](http://www.miele.sg)

## South Africa

Miele (Pty) Ltd  
63 Peter Place, Bryanston 2194  
P.O. Box 69434, Bryanston 2021  
Tel: (011) 875 9000  
Fax: (011) 875 9035  
E-mail: [info@miele.co.za](mailto:info@miele.co.za)  
Internet: [www.miele.co.za](http://www.miele.co.za)

## Taiwan

K.E. & Kingstone Co., Ltd.  
6th Fl., No. 120, Sec. 2  
Jianguo N. Rd.  
Taipei, Taiwan  
TEL: +886 2 2502-7256  
FAX: +886 2 2502-3077  
E-mail: [kenk@kenk.com.tw](mailto:kenk@kenk.com.tw)  
Website:  
[www.kenk.com.tw/ke/miele](http://www.kenk.com.tw/ke/miele)

## Thailand

BHIRAJ TOWER at EmQuartier  
43rd Floor Unit 4301-4303  
689 Sukhumvit Road  
North Klontong Sub-District  
Vadhana District  
Bangkok 10110, Thailand

## United Arab Emirates

Miele Appliances Ltd.  
Showroom 1  
Eiffel 1 Building  
Sheikh Zayed Road, Umm Al Sheif  
P.O. Box 114782 - Dubai  
Tel. +971 4 3044 999  
Fax. +971 4 3418 852  
800-MIELE (64353)  
E-Mail: [info@miele.ae](mailto:info@miele.ae)  
Website: [www.miele.ae](http://www.miele.ae)

**Manufacturer:** Miele & Cie. KG, Carl-Miele-Straße 29, 33332 Gütersloh, Germany

KM 7617 FX, KM 7667 FR, KM 7667 FL, KM 7677 FR,  
KM 7677 FL, KM 7867 FL