

ASKO



Instructions for use
GAS-INDUCTION HOB
HIG1995AD

Pictograms used:



Important information



Tip

CONTENTS

Your gas-induction hob

Introduction	4
Control panel	6
Description	7

Safety instructions

Temperature safety	8
Cooking-time limiter	8

Use induction

Using the touch controls	9
Induction cooking	9
How does induction work	10
Induction noises	10
Pans	11

Operation induction

Switching on the hob and setting the power	13
Residual warmth indicator	13
Boost	14
Two cooking zones behind each other	14
How to bridge the Vario induction zones	15
Switching off	16
Stand-by modus	16
Eco stand-by modus	16
Child lock	17
Pause	18
Recognizing a mode	18
Timer / Kitchen timer	19
Switching on and off the beep	21
Automatic pan detection	21
Automatic cooking programs	22
Healthy cooking	25
Cooking settings	26

Maintenance induction

Cleaning	27
----------	----

Faults induction

General	28
Troubleshooting table	28

Operation gas

Ignition and adjustment	30
Use	30

Maintenance gas

Cleaning	33
----------	----

Faults gas

Troubleshooting table	34
-----------------------	----

Environmental aspects

Disposal of packaging and appliance	36
-------------------------------------	----

YOUR GAS-INDUCTION HOB

Introduction

This hob has been designed for the real lover of cooking. The hob consists of a gas wok burner and four induction cooking zones.

Cooking on an induction hob has a number of advantages. It is easy, because the hob reacts quickly and can also be set to a very low power level. Because, moreover, it can also be set to a high power level, it can bring things to the boil very quickly. The ample space between the cooking zones makes cooking comfortable.

Cooking on an induction hob is different from cooking on a traditional appliance. Induction cooking makes use of a magnetic field to generate heat. This means that you cannot use just any pan on it. The pans section gives more information about this.

You can prepare wok dishes much more effectively with the high-power wok burner (gas). Thanks to the spark ignition integrated into the knob, you can ignite and operate the wok burner with one hand.

For optimum safety the wok burner is fitted with a thermo-electric flame protection. The induction part of the hob is equipped with several temperature protections and a residual heat indicator, which shows which cooking zones are still hot.

This manual describes how you can make the best possible use of the induction hob. In addition to information about operation, you will also find background information that can assist you in using this product. You will also find cooking tables and maintenance tips.

Read the manual thoroughly before using the appliance, and store these instructions in a safe place for future reference.

YOUR GAS-INDUCTION HOB

The manual also serves as reference material for service technicians.

Please, therefore, stick the appliance identification card in the space provided, at the back of the manual. The appliance identification card contains all the information that the service technician will need in order to respond appropriately to your needs and questions.

Enjoy your cooking!



Attention

Pans that have already been used for cooking on a gas hob are no longer suitable for use on an induction hob.

YOUR GAS-INDUCTION HOB

Control panel

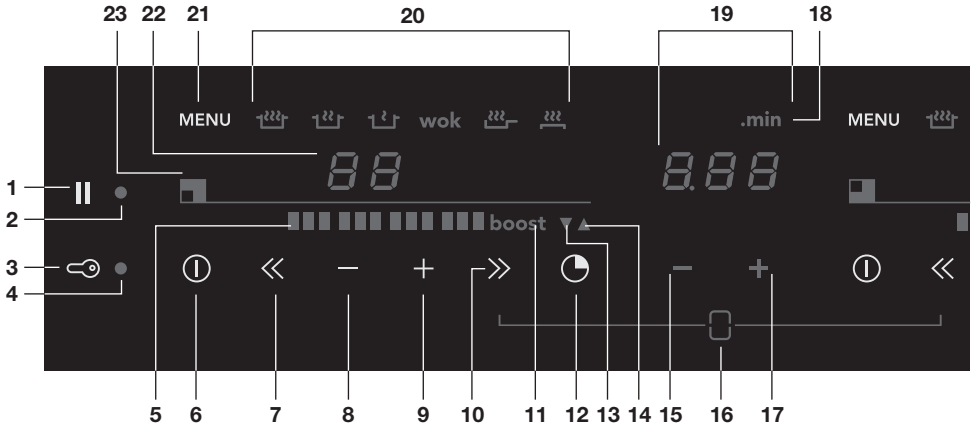

1. Pause button
2. Pause indicator
3. Childproof lock/Eco stand-by button
4. Childproof lock indicator/Eco stand-by indicator
5. Level indicator in cubes
6. On/off button
7. Reduce the power quickly
8. Reduce the power
9. Raise the power
10. Raise the power quickly
11. Boost
12. Timer/alarmclock button
13. Alarmclock indicator
14. Cooking time indicator
15. 'Reduce the time' button
16. Bridge function (Two zones are connected; this creates one 'big' zone. Control 2 zones with one slider).
17. 'Raise the time' button
18. 'Minutes after dot' indicator
19. Timer/alarmclock
20. Menu functions
21. Menu button
22. Level indicator
23. Cooking zone indicator

YOUR GAS-INDUCTION HOB

Description

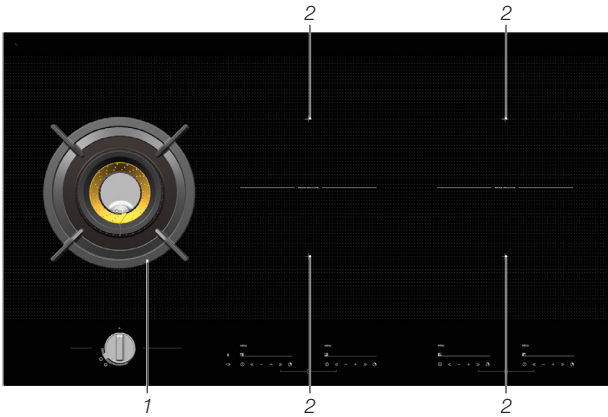

1. Cookingzone left wok burner (gas)
2. Vario zone 180 x 220 mm 3,7 kW (zones that can be connected)

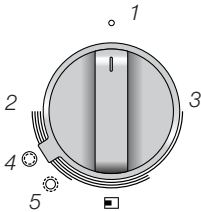

1. 0 position
2. High setting
3. Low setting
4. Wok setting (wok burner)
5. Roasting setting (wok burner)



Before use, read the separate safety instructions first!

Temperature safety

- A sensor continuously measures the temperature of certain parts of the hob. Every induction zone is equipped with a sensor that measures the temperature of the bottom of the pan to avoid any risk of overheating when a pan boils dry. In case of temperatures rising too high, the power is reduced automatically or the hob switches off automatically.

Cooking-time limiter



- The cooking-time limiter is a safety function of your cooking appliance. It will operate if you forget to switch off your hob.
- Depending on the setting you have chosen, the cooking time will be limited as follows:

Setting	The cooking zone switches automatically off after:
1 and 2	9 hours
3, 4 and 5	5 hours
6, 7 and 8	4 hours
9	3 hours
10	2 hours
11 and 12	1 hour

The cooking-time limiter switches the cooking zones off if the time in the table has elapsed.

Setting	The cooking zone switches automatically to setting 12 after:
boost	10 minutes

USE INDUCTION

Using the touch controls

The touch controls may take some getting used to if you are used to other (rotary) controls. Place the tip of your finger flat on the control to achieve the best results. You do not have to apply any pressure.

The touch sensors only react to the light pressure of a fingertip. Do not operate the controls with any other objects. The hob will not switch on when your pet walks over it.

Induction cooking

Induction cooking is fast

- To start you will be surprised by the speed of induction cooking. Especially at higher settings, foods and liquids will boil very rapidly. It is best not to leave pans unattended to avoid them boiling over or boiling dry.

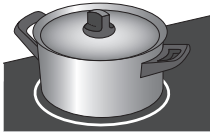

No heat loss and cold handles with induction cooking.

The power will be adjusted

- In the case of induction cooking, it is only the part of the zone on which the pan stands that is used. If you use a small pan on a large zone, the power will be adjusted to the diameter of the pan. The power will thus be lower and it will take longer before the food in the pan comes to the boil.

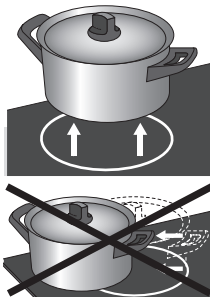

Attention

- Grains of sand may cause scratches which cannot be removed. Only put pans with a clean base on the cooking surface and always pick pans up to move them.
- Do not use the hob as a worktop.
- Always keep the lid on the pan when cooking, in order to avoid energy loss.

USE INDUCTION

How does induction work

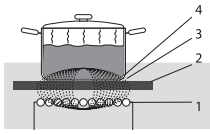

The coil (1) in the hob (2) generates a magnetic field (3). By placing a pan with an iron base (4) on the coil, a current is induced in the base of the pan.

A magnetic field is generated in the appliance. By placing a pan with an iron base on a cooking zone, a current is induced in the pan base. This induced current generates heat in the base of the pan.

Easy

The electronic controls are accurate and easy to set. On the lowest setting, you can melt chocolate directly in the pan, for example, or cook ingredients that you would normally heat in a bain-marie.

Fast

Thanks to the induction hob's high power levels, bringing food to the boil is very quick. Cooking food through takes just as long as for other types of cooking.

Clean

The hob is easy to clean. Because the cooking zones do not get any hotter than the pans themselves, food spills cannot burn on.

Safe

The heat is generated in the pan itself. The glass top does not get any warmer than the pan. This means that the cooking zone is considerable cooler compared to that from a Ceramic hob or a gasburner. Once a pan has been taken away, the cooking zone cools down quickly.

Induction noises

A ticking sound

This is caused by the capacity limiter on the front and back zones. Ticking can also occur at lower settings.

Pans are making noise

Pans can make some noise during cooking. This is caused by the energy flowing from the hob to the saucepan. At high settings this is perfectly normal for some pans. It will not damage either the pans or the hob.

The fan is making noise

To enlarge the lifespan of the electronics, the appliance is equipped with a fan. If you use the appliance intensely, the fan is activated to cool down the appliance and you will hear a buzzing sound. The fan runs on for several minutes after the hob has been switched off.

Automatic power-on function

When the automatic power-on function (APD) is active, you will hear a ticking noise, even if the zone is not being used.

Pans

Pans for induction cooking

Induction cooking requires a particular quality of pan.



Attention

- Pans that have already been used for cooking on a gas hob are no longer suitable for use on an induction hob.
- Only use pans that are suitable for electric and induction cooking with:
 - a thick base (minimum 2.25 mm);
 - a flat base.
- The best are pans with the 'Class Induction' quality mark.



Tip

You can check for yourself whether your pans are suitable using a magnet. A pan is suitable if the base of the pan is attracted by the magnet.

Suitable	Unsuitable
Special stainless steel pans	Earthenware
Class Induction	Stainless steel
Hard-wearing enamelled pans	Porcelain
Enamelled cast-iron pans	Copper
	Plastic
	Aluminium

One is advised to use the pans recommended by Asko for the automatic cooking programs.



Attention

Be careful with enamelled sheet-steel pans:

- the enamel may chip (the enamel comes loose from the steel), if you switch the hob on at a high setting when the pan is (too) dry;
- the base of the pan may warp - due, for example, to overheating or to the use of too high a power level.



Attention

Never use pans with a misshapen base. A hollow or rounded base can interfere with the operation of the overheating protection, so that the appliance becomes too hot. This may lead to the glass top cracking and the pan base melting. Damage arising from the use of unsuitable pans or from boiling dry is excluded from the guarantee.

Pan diameter

The maximum pan diameter is 18 cm. The diameter of the bottom of the pan must be at least 12 cm. If a pan is too small the zone will not work.

Pressure cookers

Induction cooking is very suitable for cooking in pressure cookers.

The cooking zone reacts very quickly, and so the pressure cooker is quickly up to pressure. As soon as you switch a cooking zone off, the cooking process stops immediately.

Switching on the hob and setting the power

The cooking zones have 12 levels. Beside it there is a level 'boost'.

1. Place a pan in the middle of a cooking zone.
2. Press the child lock button.

You will hear a single beep.

3. Press the on/off button of the cooking zone concerned.

A flashing '-' appears in the display and you will hear a single beep. If no further action is taken, the cooking zone will automatically switch off after a few seconds.

4. Press the + or - button, or the << or >> button to select the desired setting. The cooking zone starts automatically in the level that has been set (when a pan is detected).

- ▷ If you press the + or - button first, level 6 appears.
- ▷ If you press the >> button first, level 12 + 'boost' appear in the display. This is power level 'boost' and you can use this setting if you want to bring dishes to the boil quickly (see page 14).
- ▷ If you press the << button first, level 1 will appear.



Tips

- With the + or - button you can raise or reduce the power setting step by step. By pressing the << or >> button, you can raise or reduce the power setting quick.
- Press and hold the << , - , + or >> button to set the desired power level more quickly.

Pandetection

If the hob does not detect a (ferrous) pan after the cooking power has been set, the display will blink and the hob will remain cold. If a (ferrous) pan is not placed on the cooking zone within 1 minute, the cooking zone will automatically switch off.

Residual warmth indicator

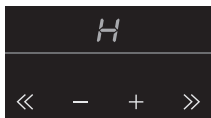

A cooking zone that has been used intensively will retain heat for several minutes after it has been switched off. An 'H' appears in the display as long as the cooking zone is hot.

Boost

You can use the 'boost' function to cook at the highest power level during a short period of time (max. 10 minutes). After the maximum boost time the power will be reduced to setting 12.



Switching on 'boost'

1. Put a pan on a cooking zone.
2. Press the >> button immediately after you have switched on the zone.

Level 12 and 'boost' appear in the display.

- If a cooking zone has already been set to a power level and you want to use 'boost', press several times the >> button or the + button of the cooking zone concerned.

Switching off 'boost'

'Boost' has been switched on, the display shows level 12 and 'boost'.

1. Press the << button or the - button.

In the display you will see a lower level.

Or:

2. Press the on/off button of the cooking zone you want to switch off.

You will hear a beep and the level in the display disappears.

The cooking zone has been switched off completely.

Two cooking zones one in front of the other

- Two cooking zones one in front of the other affect each other. When both of these cooking zones are switched on at the same time, the power is automatically shared between them. The first set cooking zone will remain at the set setting at all times. The maximum set setting for the cooking zones to the front or back that is added later, depends on the setting of the first cooking zone. When you have reached the maximum amount of cooking setting combinations, the last set setting will start to flash and is automatically lowered to the highest possible setting.
- Two cooking zones alongside each other have no effect on each other. You can set both cooking zones on a high setting.
- If the vario zones are bridged, they cannot be set to boost and the menu functions cannot be used.

How to bridge the Vario induction zones

The Vario induction zones can be bridged (linked) to each other. This creates 1 large zone that can be used for example for a large fish pan or one large cooking pan.

- If the vario zones are bridged, they cannot be set to boost and the menu functions cannot be used.

Use a (fish) pan where at least one of the centre/middle positions of the vario zones is covered.

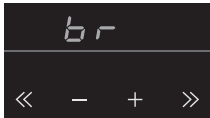

Activating the bridge mode

1. Place the large pan on both cooking zones so that these are both well covered.
2. Switch the front cooking zone on.
3. Hold two keys down at the same time (for a few seconds): first press the << button on the rear vario zone and then immediately the >> button on the front vario zone.

'BR' will appear in the display on the rear zone. Then use the front zone control to set a cooking level for both zones.

4. Set the desired cooking level using the + or - button, or the << or >> button of the front zone. Both zones are heated in the level set.

Deactivating the bridge mode

1. Press simultaneously on the >> button on the front vario zone and the << button on the very back vario zone to switch off the 'bridge' level.

Or:

2. Press the on/off button of the cooking zone you want to switch off. *You will hear a beep and the level in the display disappears. The cooking zone has been switched off completely.*

Switching off

Switching off one cooking zone

Press the on/off button of the cooking zone you want to switch off.

You will hear a beep and the level in the display disappears.

- If all cooking zones have been switched off in this way, the hob will automatically be in the stand-by mode (also refer to 'stand-by mode').

Switching off all cooking zones

Press the child lock button to switch off all the cooking zones at the same time.

You will hear a beep. The red childproof lock indicator next to the child lock button will blink very slowly.

- The induction hob is now in eco stand-by modus (see also 'eco stand-by modus').

Stand-by mode

In stand-by mode the induction hob is switched off. You can switch to the stand-by mode from the eco stand-by mode, or by switching off all cooking zones.

From the stand-by mode you can directly start cooking by pressing the on/off button of the desired cooking zone.

Switching the hob from the eco stand-by mode to the stand-by mode

The red light next to the child lock button keeps slowly going on and off.

- Press the child lock button for a short while to switch to the stand-by mode.

A single beep will be heard. All lights on the hob are out.

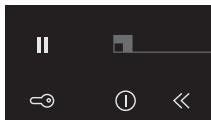

Eco stand-by mode

In the eco stand-by mode the hob is switched off and it uses as little energy as possible.

The hob can also be switched to the eco stand-by mode from the stand-by mode and when cooking zones are still active.



Did you know that

The hob uses less than 0,5 Watt in the eco- stand-by mode. That is even less than in the stand-by mode of the hob.

Switching the hob to the eco stand-by mode

- Press the child lock button.

You will hear a single beep. The eco stand-by mode is active, the red light next to the child lock button keeps slowly going on and off.

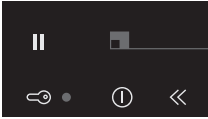

From the eco stand-by mode you can't immediately start cooking. To be able to, the hob first needs to be switched to the stand-by mode.



Did you know that

After 30 minutes in the stand-by mode the hob will automatically switch to the eco stand-by mode to prevent unnecessary energy consumption.

Child lock

Your induction hob is equipped with a childproof lock that lets you lock the appliance. It prevents unintended switching on.

Switching on the child lock

1. Press the child lock button for two seconds.

You will hear a double beep. All buttons are in-active now, except for the child lock button. The hob first switches to the eco stand-by mode and then to the childproof lock mode. The red light is constantly on.

2. Press the button again for 2 seconds to get the hob of the childproof lock.

A single beep will be heard. The hob is now in the stand-by mode. The red light next to the child lock button is out.

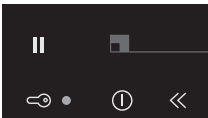

Tip

Set the hob to the child lock mode before cleaning the hob to prevent it from accidentally switching on.



Did you know that

When the hob is set to the child lock, it uses just as little energy as when it is in the eco stand-by mode.

Pause

With this pause function, you can set the entire hob to 'pause' for 5 minutes during cooking. In this way you can leave or clean the hob in a safe way during a short period of time, without losing settings.

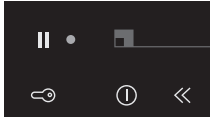

Switching the hob to the pause mode

- Press the pause button once.
You will hear a double beep, the settings change into a lower setting and the red light next to the pause button flashes.
 - ▷ Any set timers/kitchen timers stop. All cooking zones are automatically changed to a lower setting.
 - ▷ All buttons are inactive except for the child lock button and the pause button.
 - ▷ The on/off button of the individual cooking zones also remain active, they do however react with a delay of two seconds.
- If you press the pause button again within 5 minutes, the paused cooking process will be resumed.
You will hear a double beep, the hob resumes the settings as they were set before the pause.
- If you do not undertake any further action within 5 minutes:
All active cooking zones will be switched off automatically. After that the pause button will keep flashing for 25 minutes to indicate the cooking processes have been ended by the pause mode. The hob automatically switches from the pause mode to the eco stand-by mode after 25 minutes.

Recognizing a mode

The stand-by mode	Not a single light is lit.
The eco stand-by mode	The red light next to the child lock button keeps slowly going on and off.
The child lock mode	The red light next to the child lock button is constantly on.
The pause mode	The red light next to the pause button flashes.

Timer / Kitchen timer

The timer/alarmclock button of each cooking zone has two functions:

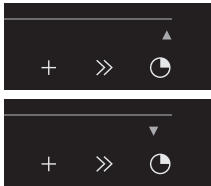

The timer function	The kitchen timer function
This function can be recognized by the red small arrow pointing up.	This function can be recognized by the red small arrow pointing down.
The time increases in the timer function.	The time decreases in the kitchen timer function.
The timer cannot be linked to a cooking zone.	The kitchen timer can be linked to a cooking zone. This means the cooking zone switches off if the set time has passed.
When the timer button is pressed, the timer function automatically switches on after 3 seconds if you do nothing.	The kitchen timer function can be reached from the timer function by pressing the red + button or red - button.



Attention

- Per set of two cooking zones (front and back) one timer/kitchen timer is available.
- The timer/kitchen timer can only be linked to one of both cooking zones per set of two cooking zones.
- The timer-/kitchen timer function can also be used without activating an accompanying cooking zone.

Switching on the timer

1. Press the timer/alarmclock button of the cooking zone once.

The display of the timer lights up and you'll see three zeroes flashing. Under that appears a + and -.

- If you do not set a time with the + or - button, the timer will start running automatically after 3 seconds. The timer can go as far as 9 hours and 59 minutes.

The red arrow pointing up lights up and the time increases.

2. Press the timer/alarmclock button of the cooking zone again, to switch it off.

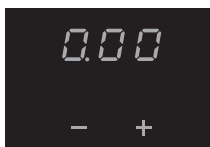

Switching on the kitchen timer

1. Press the timer/alarmclock button of the cooking zone once.
2. Press the + or - button to switch from the timer function to the kitchen timer function. After that you can set the desired cooking time with the + button. Then you can change the set time with the - button.

The red small arrow pointing down lights up. Time is counting down.

3. Press the timer/alarmclock button of the cooking zone again, to switch it off.



Attention

- The kitchen timer is linked to the cooking zone if the accompanying cooking zone is switched on. The kitchen timer stops as soon as the pan is removed and resumes when the pan is put back.
- If the kitchen timer is linked to a cooking zone, the cooking zone will switch off after the set time has passed.

The kitchen timer alarm beeps for a quarter of an hour while decreasing as the time passes, while '0.00' and the arrow pointing down keeps flashing. Press the timer/alarm clock button of the cooking zone again, to switch off the kitchen timer alarm. Press the timer/alarm clock button again for the cooking zone where the red arrow pointing down is flashing, or remove the pan from the zone to switch off the timer again.

Setting the cooking time

- Switch the kitchen timer on.

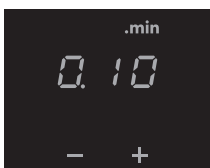
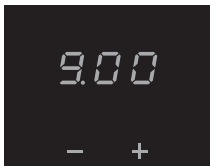

Button	Steps of x per button contact	Time
+	x = 1 minute	0.00 to ...
-	x = 10 seconds	5.00 - 0.00
-	x = 30 seconds	9.00 - 5.00
-	x = 1 minute	... to 9.00

After 9 minutes and 0 seconds ('9.00') the word '.min' appears above the display and the minutes will be added behind the dot.



Tip

You can press and hold the + or - button to set the desired cooking time quicker.

Switching on and off the beep

1. Press the on/off button on the far left twice.
2. Press and hold the << button and the + button simultaneously until you hear a beep.

The beep is now switched off for all button operations, except for the pause button and the child lock button. Note: the kitchen timer alarm and the beep for error messages cannot be switched off.

3. Use the same button combination to switch the sound back on.

Switching on/off the automatic pan detection

If, after the hob has been turned on, a pan is placed in an inactive cooking zone, the corresponding operating controls light up and this can be used immediately (without operating the on/off switch).

If the cooking zone is not activated within 10 seconds, the light will go out. It can be re-activated by removing the pan and then replacing it or by using the on/off switch.

This function is active by default, but can also be switched off. This is done by switching the hob off and operating the 'Menu' and 'on/off button' on the left-hand control panel for 5 seconds. 'APd OFF' will appear on the display. By repeating this process, the function can be reactivated and the 'APd On' will appear on the display.

Automatic cooking programs

Your hob is fitted with 6 automatic cooking programs. You can set any end time of an automatic cooking program with the aid of the kitchen timer function. The cooking programs are based on regular quantities. The tables are meant as a guideline, because of the large margins you can alter the dish according to your wishes.

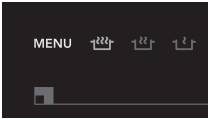

To set an automatic program

The cooking zone is switched on.

- Press the menu button.
- Again press the menu button, or press and hold down the menu button to go to the next menu functions.

The selected cooking programme automatically starts after 3 seconds. An 'A' for 'automatic' appears in the display.

If an automatic cooking program is active, you can use the following buttons to go back to the manual cooking process:

<< , + , - , >> .



Attention

For 'Vario' appliances, the cooking programs and boost function will not work if the zones are bridged.



Boiling function*/**

This function brings the content of the pan to a boil (100 °C) and keeps it boiling. A beep can be heard when the content is cooking or if the food has to be added. This function works only with the lid on the pan.

Dish	Number of people	Quantity	Pan	Zone	Fill the pan up to: (start the cooking process)
Cooked potatoes	6 - 8	1000 - 1400 g	High pan (Ø 200)	Ø 210 / Vario	2,5 l incl. potatoes
Cooked (hard) vegetables	4 - 6	500 - 750 g	High pan (Ø 200)	Ø 210 / Vario	2,5 l incl. vegetables
Rice	4 - 5	400 - 500 g	High pan (Ø 240)	Ø 210 / Vario	2,0 l only water ¹⁾
Pasta	2 - 3	200 - 300 g	High pan (Ø 200)	Ø 210 / Vario	2,0 l only water ¹⁾

1) After the beep the rice or pasta can be added.

* This function works best with pans recommended by Asko (please refer to www.asko.com).

** These menu functions work best if they are started at the beginning of the cooking process.



Simmering function*

The temperature of the dish is constantly kept near the boiling point (90 °C - 95 °C). The simmer setting works best with a lid on the pan. Thicker dishes have to be stirred every 15 minutes. The maximum simmering time is 8 hours, unless a shorter time has been set with the aid of a timer.

Dish	Quantity +/-	Pan	Zone
Sauce or soup	1 l	Low pan (Ø 200)	Ø 210 / Vario
	1,5 l	High pan (Ø 200)	Ø 210 / Vario



Function for keeping warm*

The temperature of a dish is automatically kept at a constant temperature of 70 °C - 75 °C. The setting for keeping warm works best with a lid on the pan. Larger quantities and thicker dishes need to be stirred occasionally. The maximum time for keeping warm is 8 hours, unless a shorter time has been set with the aid of a timer.

Dish	Number of people	Quantity +/-	Pan	Zone
All dishes	4	2000 g	High pan (Ø 200)	Ø 210 / Vario

* This function works best with pans recommended by Asko (please refer to www.asko.com).

wok

Wok function*/**

The wok setting provides an optimal wok temperature, for both the oil and the wok. After the beep the pan has reached its temperature, the oil can be put in the pan and then the dish.

Dish	Number of people	Maximum amount of meat or fish / vegetables	Pan	Zone
Meat, fish, vegetables	3 - 4	600 g / 600 g	Wokpan	Ø 210 / Vario



Searing function*/**

The searing setting provides the optimal searing temperature. After the beep the pan has reached its temperature. The oil or butter can be put into the pan and then the dish.

Dish	Number of people	Quantity	Pan	Zone
Meat, fish	4 - 5	400 - 500 g	Frying pan	Ø 210 / Vario

* This function works best with pans recommended by Asko (please refer to www.asko.com).

** These menu functions work best if they are started at the beginning of the cooking process.



Grill function*/**

The grill setting provides the optimal grilling temperature. A beep can be heard when the pan has reached its temperature.

Dish	Number of people	Quantity	Pan	Zone
Meat, fish, vegetables	3 - 4	300 - 400 g	Grill pan / plate	Ø 210 / Vario

Healthy cooking

Burning point of different types of oil

To ensure your food is fried as healthily as possible, Asko recommends choosing the type of oil according to the frying temperature. Each oil has a different burning point at which toxic gasses are released. The below table shows the burning points for various types of oil.

Oil	Smoke point °C
Extra virgin olive oil	160 °C
Butter	177 °C
Coconut oil	177 °C
Canola oil	204 °C
Virgin olive oil	216 °C
Sunflower oil	227 °C
Corn oil	232 °C
Peanut oil	232 °C
Rice oil	255 °C
Olive oil	242 °C

* This function works best with pans recommended by Asko (please refer to www.asko.com).

** These menu functions work best if they are started at the beginning of the cooking process.

Cooking settings

Because the settings depend on the quantity and composition of the contents of the pan, the table below is intended as a guideline only.

Use setting 'boost' and setting 11 and 12 to:

- bring the food or liquid to the boil quickly;
- 'shrink' greens;
- heat oil and fat;
- bring a pressure cooker up to pressure;
- wok

Use setting 9 and 10 to:

- sear meats;
- cook fish;
- cook omelettes;
- fry boiled potatoes;
- deep fry foods.

Use setting 7 and 8 to:

- fry thick pancakes;
- fry thick slices of breaded meat;
- fry bacon (fat);
- cook raw potatoes;
- make French toast;
- fry breaded fish;
- cook through pasta;
- fry thin slices of breaded meat;
- fry thin slices of meat;

Use setting 4-6 to:

- complete the cooking of large quantities;
- defrost hard vegetables;
- fry thick slices of breaded meat.

Use settings 1-3 to:

- simmer bouillon;
- stew meats;
- simmer vegetables;
- melt chocolate;
- poach;
- keep warm;
- melt cheese.

Cleaning

Tip

Set the child lock before you start cleaning the hob.

Daily cleaning

- Although food spills cannot burn into the glass, we nevertheless recommend you to clean the hob immediately after use.
- Best for daily cleaning is a damp cloth with a mild cleaning agent.
- Dry with kitchen paper or a dry tea cloth.

Stubborn stains

- Stubborn stains can also be removed with a mild cleaning agent such as washing-up liquid.
- Remove water marks and lime scale with vinegar.
- Metal marks (caused by sliding pans) can be difficult to remove. Special agents are available.
- Use a glass scraper to remove food spills. Melted plastic and sugar is also best removed with a glass scraper.



Never use

- Never use abrasives. They leave scratches in which dirt and lime scale can accumulate.
- Never use anything sharp such as steel wool or scourers.

TROUBLESHOOTING INDUCTION

General

If you notice a crack in the glass top (however small), switch the hob off immediately, unplug the hob, turn off the (automatic) fuse switch(es) in the meter cupboard or, in the event of a permanent connection, set the switch in the power supply lead to zero. Contact the service department.

Troubleshooting table

If the appliance does not work properly, this does not always mean that it is defective. Try to deal with the problem yourself first by checking the points mentioned below or check for more information the website 'www.asko.com'.

Symptom	Possible cause	Solution
The display lights up when the hob is activated for the first time.	This is the standard set-up routine.	Normal operation.
The fan runs on for several minutes after the hob has been switched off.	The hob is cooling.	Normal operation.
A slight smell is noticeable the first few times the hob is used.	The new appliance is heating up.	This is normal and will disappear once it has been used a few times. Ventilate the kitchen.
You can hear a ticking sound in your hob.	This is caused by the capacity limiter on the front and back zones. Ticking can also occur at lower settings.	Normal operation.
The pans make a noise while cooking.	This is caused by the energy flowing from the hob to the saucepan.	At high settings this is perfectly normal for some pans. It will not damage either the pans or the hob.
You have switched on a cooking zone, but the display keeps flashing.	The pan you are using is not suitable for induction cooking, or has a diameter of less than 12 cm.	Use a suitable pan.

TROUBLESHOOTING INDUCTION

Symptom	Possible cause	Solution
A cooking zone suddenly stops working and you hear a signal.	The preset time has ended.	Switch the bleep off by pressing the + or - button of the timer.
The hob is not working and nothing appears in the display.	There is no power supply due to a defective cable or a faulty connection.	Check the fuses or the electric switch (if there is no plug).
A fuse blows as soon as the hob is switched on.	The hob has been wrongly connected.	Check the electrical connections.
'br' appears in the display and the touch controls are not working.	The bridge function is activated.	Deactivate the bridge function.
Error code F00.	The control panel is dirty or has water lying on it.	Clean the control panel.
Error code F0 up to and including F6 and FC.	Defective generator.	Contact the service department.
Error code F7.	The ambient temperature is not good.	Switch off all heat sources in the vicinity of the cooking plate.
Error code F8 and F08.	Appliance over heated.	The appliance has been switched off because of over heating. Let the appliance cool down and start again on a lower setting.
Error code F9 and/or continuous beep.	The appliance has been connected incorrectly and/or the mains voltage is too high.	Let your connection be changed.
Error code F99.	You have pressed two or more buttons at the same time.	Do not operate more than one button at the same time.
Error code FA.	Mains voltage is too low.	Contact your energy supplier.
Error code FAN.	Air circulation not good.	Make sure the venting holes under the cooking plate are open.
Other error codes.	Defective generator.	Contact the service department.

Ignition and adjustment

The burner is fully adjustable between high and low settings.

- Press the control knob and turn it anticlockwise. The burner will ignite.
- Keep the control knob fully depressed for at least 3 seconds between high and low settings. The flame failure device will be activated.
- Turn the wok control knob to the low setting (3).
- If desired, turn the wok selector ring to the roasting setting (5). The inner ring (wok setting) will switch off and the outer ring (roasting setting) will switch on.
- The wok burner will switch automatically to the wok setting if the control knob of the wok burner is set to 0.



Please note!

It is possible to switch between wok setting and roasting setting and back during cooking.

Please note! If the control knob is in the off setting (0-setting) the selector ring cannot be changed to the roasting setting. Always turn this knob back completely to 0!

Use



error

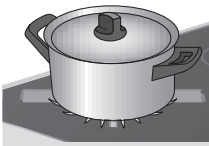

good

Pans

- Always ensure that the flames stay under the pan. A lot of energy is lost if flames burn around the pan. The handles may also become too hot.
- Do not use pans with a base diameter smaller than 12 cm. Smaller pans are not as stable.

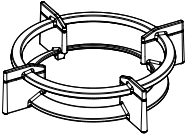

wok ring

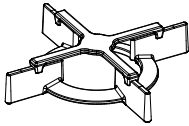

small pan grid

Wok ring and small pan grid

The wok ring for use with the wok burner supplied or obtainable as an accessory provides extra stability for woks with a round base.

The small pan grid supplied or obtainable as an accessory makes it possible to use very small pans.

Do not use the wok ring on the wok roasting setting. This can result in discolouring.

Pan support

Place the pan support vertically, without sliding over the drip tray. Use the leads to position the pan support on the drip tray.

Wok burner

Place the wok burner correctly. Placing the wok burner parts incorrectly can result in a poorly functioning burner.

1. Place the burner distributor (2) in the burner housing (1).
2. Use the leads to place the inner ring (3) on the burner distributor (2).
3. Use the leads to place the outer ring (4) on the burner distributor (2).

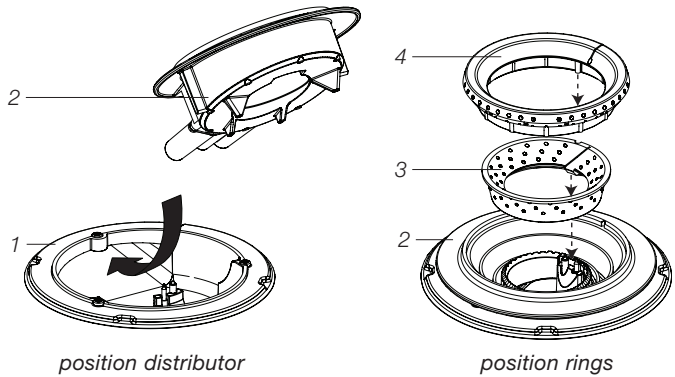

position distributor

position rings

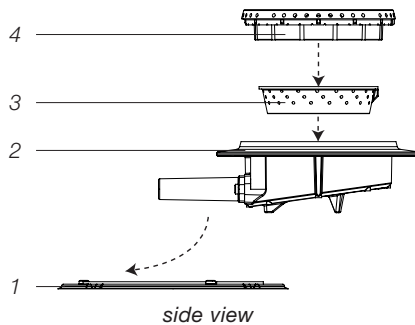

side view

Cleaning

Regular maintenance after use prevents spilt food from setting too long and creating stubborn stains. Use a mild detergent for this. First clean the control knob, burner and pan support and only then the drip tray or glass cover. This prevents the drip tray or glass cover to becoming dirty again after cleaning.



Please note!

Do not clean burner parts in the dishwasher. Dishwasher detergent can corrode burner parts!

Persistent stains on enamel (pan supports, burner caps)

Persistent stains can best be removed with a fluid detergent or a plastic scouring sponge. Never use scouring powder, scouring pads, sharp objects or aggressive cleaning products.

Persistent stains on the glass cover

Clean the glass cover with a special cleaning product for ceramic hobs. Water stains or limescale are best cleaned using cleaning vinegar.

Brass wok burner parts

Some wok burner parts are made from brass. It is normal for the brass colour to change as a result of the high temperatures involved in wok use.



Please note!

Consult the www.asko.com website for additional maintenance and cleaning instructions!

FAULTS GAS

Troubleshooting table

If your gas hob does not work properly, this does not always mean that it is defective. Try to deal with the problem yourself first by checking the points below or check the 'www.asko.com' website for more information.

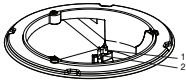
Symptom	Possible cause	Solution
You smell gas near the appliance.	The appliance connection is leaking.	Close the main gas switch. Contact the your installer.
A burner does not ignite. 	<p>The electrical connection is incorrect.</p> <p>Fuse defective/fuse switched off in fuse cupboard.</p> <p>Spark plug (1) dirty/damp.</p> <p>Burner parts not placed correctly.</p> <p>Burner parts dirty/damp.</p> <p>Main gas tap closed.</p> <p>Fault in gas mains.</p> <p>Gas bottle or tank is empty.</p> <p>Wrong type of gas used.</p>	<p>Contact your installer.</p> <p>Put in a new fuse or switch on the fuse in the fuse box.</p> <p>Clean/dry the spark plug.</p> <p>Use the centring leads to put the burner parts together.</p> <p>Clean/dry the burner parts. Make sure that the outflow holes are open.</p> <p>Open the main gas tap.</p> <p>Consult you gas supplier.</p> <p>Connect a new gas bottle or have the tank refilled.</p> <p>Check whether the gas used is suitable for the appliance. Contact your installer if it is not correct.</p>
The burner does not burn evenly.	<p>Burner parts not placed correctly.</p> <p>Burner parts dirty/damp.</p> <p>Wrong type of gas used.</p>	<p>Use the centring leads to put the burner parts together.</p> <p>Clean/dry the burner parts. Make sure that the outflow holes are open.</p> <p>Check whether the gas used is suitable for the appliance. Contact your technician if it is not correct.</p>

FAULTS GAS

Symptom	Possible cause	Solution
Burner extinguishes after igniting.	The control knob has not been depressed long or deep enough (at least 3 seconds).	Keep the control knob fully depressed for at least 3 seconds between high and low settings. This can take longer the first time because of the gas supply.
	Thermocouple (2) is dirty.	Clean/dry thermocouple.
Ceramic glass plate broken.	Object fallen onto it.	Close the gas main switch and pull the plug out of the socket. Contact the your installer. Please note! Do not throw a broken ceramic glass plate in the glass recycling bin but take this to the Municipality's waste recycling centre.

Disposal of packaging and appliance

In the manufacturing of this appliance durable materials were used. Make sure to dispose of this equipment responsibly at the end of its lifecycle. Ask the authorities for more information regarding this.

The appliance packaging is recyclable. The following may have been used:

- cardboard;
- polythene film (PE);
- CFC-free polystyrene (PS hard foam).

Dispose of these materials in a responsible manner and in accordance with government regulations.



As a reminder of the need to dispose of household appliances separately, the product is marked with the symbol of a crossed-out wheeled dustbin. This means that at the end of its working life, the product must not be disposed of as urban waste. It must be taken to a special local authority differentiated waste collection centre or to a dealer providing this service.

Disposing of a household appliance separately avoids possible negative consequences for the environment and health deriving from inappropriate disposal and enables the constituent materials to be recovered to obtain significant savings in energy and resources.

Declaration of conformity



We declare that our products meet the applicable European Directives, Decisions and Regulations and the requirements listed in the standards referenced.

ASKO



32361