



Instructions for use

Wine cooler with a freezer compartment

RWFN2684SL

RWFN2684BL

We thank you for the confidence you have shown by purchasing our appliance. We wish you find a lot of pleasure in its use.

The appliance is intended solely for household use.

The wine cooler with a freezer compartment /ZeroZone compartment (hereinafter referred to as the appliance) consists of two parts. The upper part is the wine cooler, and the lower part is the freezer/ZeroZone compartment.

The wine cooler is intended for wine storage.

The freezer compartment is intended for freezing fresh food and for long-term storage of frozen food (up to one year, depending on the type of food).

The entire freezer compartment can be turned into a **ZeroZone** compartment with a temperature around 0 °C.

TABLE OF CONTENTS

4 IMPORTANT NOTES AND WARNINGS	INTRODUCTION
8 ADVICE FOR SAVING POWER WITH REFRIGERATION APPLIANCES	
9 APPLIANCE DESCRIPTION	APPLIANCE DESCRIPTION
10 INSTALLATION AND CONNECTION	
12 CHANGING THE DIRECTION OF DOOR OPENING	
14 OPERATING THE APPLIANCE	
19 APPLIANCE INTERIOR EQUIPMENT	
22 STORING FOOD IN THE ZEROZONE COMPARTMENT	STORING AND FREEZING FOOD
24 FREEZING AND STORING FROZEN FOOD	
24 Freezing process	
25 Important warnings on freezing fresh food	
25 Storage of industrially frozen food	
26 Frozen food storage time	
26 Defrosting frozen food	
27 DEFROSTING THE APPLIANCE	DEFROSTING AND CLEANING THE APPLIANCE
28 CLEANING THE APPLIANCE	
29 TROUBLESHOOTING	OTHER
31 INFORMATION ABOUT APPLIANCE NOISE	

IMPORTANT NOTES AND WARNINGS



This appliance can be used by children aged from 8 years and above and persons with reduced physical, sensory or mental capabilities or lack of experience and knowledge if they have been given supervision or instruction concerning use of the appliance in a safe way and understand the hazards involved. Children shall not play with the appliance. Cleaning and user maintenance shall not be made by children without supervision.

Before connecting the appliance to the power mains, please read carefully the instructions for use which describe the appliance and its correct and safe use. The instructions apply for several appliance types/models; thus, settings or equipment may be described herein which is not available in your appliance. The instruction manual includes the NO FROST version/model of the freezer which is fitted with a fan and in which the defrosting process is automatic.

Remove the packaging intended for protecting the appliance or particular parts during transport.

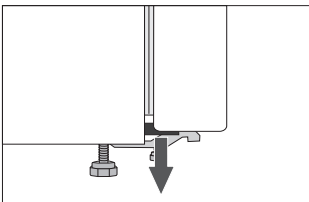

Spacers are fitted on the corners of the doors. Remove them and insert the supplied plugs into their slots (only in some models).

Before connecting the appliance to the power mains, let the appliance rest in a vertical position for approximately 2 hours. This will reduce the possibility of operation faults due to the effect of transport on the cooling system.

The appliance must be connected to the power mains and grounded in compliance with the effective standards and regulations.

The appliance may not be used outdoors and it may not be exposed to rain.

Do not store explosive substances such as aerosol cans with a flammable propellant in this appliance.

Before cleaning the appliance, unplug the appliance from the power mains (unplug the power cord from the wall outlet).

If the power cord is damaged, it must be replaced by a service technician or other adequately trained person.

If the appliance will be out of use for a prolonged period of time, switch it off using the relevant button, and unplug the appliance from the power mains. Empty the appliance, defrost it, clean it, and leave the door ajar.

If LED lighting does not work, call a service technician. Do not attempt a repair of the LED lighting yourself, as there is danger of contact with high voltage!

To protect the environment, take the obsolete appliance to an authorized home appliance collection center.

Packaging is made of environmentally friendly materials that can be recycled, disposed of, or destroyed without any hazard to the environment.

Rating plate can be found in the appliance interior. If the language on the rating plate is not the language of your choice or the language of your country, replace it with the one supplied.

WARNING! Keep ventilation openings, in the appliance enclosure or in the built-in structure, clear of obstruction.

WARNING! Do not use mechanical devices or other means to accelerate the defrosting process, other than those recommended by the manufacturer.

WARNING! Do not damage the refrigerant circuit.

WARNING! Do not use electrical appliances inside the food storage compartments of the appliance, unless they are of the type recommended by the manufacturer.

WARNING! Shelves and portable bottle case are made of natural non-treated wood. Therefore, some stains (oil, red wine etc.) may be difficult or impossible to remove. Do not touch the case and shelves if your hands are dirty! The colour of wood can change in time.



The symbol on the product or its packaging indicates that the product should not be treated as normal household waste. The product should be taken to an authorized collection center for waste electric and electronic equipment processing. Correct disposal of the product will help prevent any negative effects on the environment and health of people which could occur in case of incorrect product removal. For detailed information on removal and processing of the product, please contact the relevant municipal body in charge of waste management, your waste disposal service, or the store where you bought the product.

ADVICE FOR SAVING POWER WITH REFRIGERATION APPLIANCES

- Install the appliance as specified in the instruction manual.
- Do not open the door more often than necessary.
- Occasionally make sure air circulation underneath the appliance is unobstructed.
- Condenser unit on the rear wall should be kept clean (see chapter Cleaning the appliance).
- If the gasket is damaged or does not provide a perfect seal for other reasons, have it replaced as soon as possible.
- Store the food in tightly sealed containers or appropriate packaging.
- Before placing the food in the appliance, cool it to room temperature.
- Defrost frozen food in the refrigerator compartment.
- Remove some of the drawers from the freezer compartment as described in the instruction manual, in order to make use of the entire interior.
- Defrost your conventional freezer when an approximately 3-5 millimeter layer of frost or ice has built up on the refrigerated surfaces.
- Make sure the layout of shelves in the compartment is uniform and that the food is placed so that the air can freely circulate in the appliance interior (observe the recommended placement of food as described in the instructions).
- In appliances with a fan, do not block the fan slots.
- If you do not need the fan or the ionizer, switch them off to reduce power consumption.

APPLIANCE DESCRIPTION

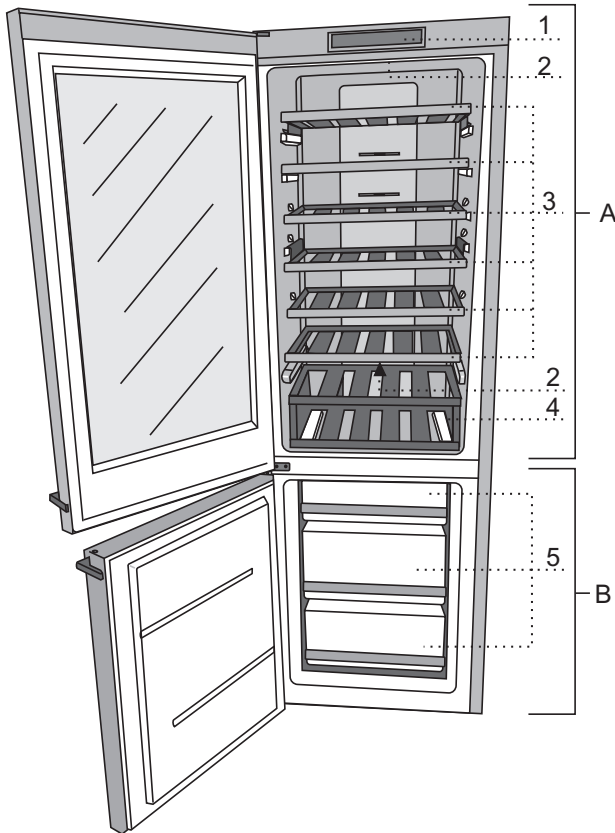

A Wine cooler

- 1 Control unit
- 2 Led lighting of refrigerator interior
- 3 Bottle shelves
- 4 Portable bottle case

B Freezer/ZeroZone compartment**

- 5 Freezer drawers/ZeroZone compartment

- The shelves are protected against pulling out. To remove a shelf, lift it at the back and then pull it out.
- The drawers are protected against pulling out. To remove a drawer from the appliance, pull it out as far as it will go, then lift at the front and pull out completely.

** Freezer/ZeroZone is an adjustable area that can be used either as a freezing compartment or a ZeroZone. When the appliance is switched on for the first time, this compartment will function as a freezer.

INSTALLATION AND CONNECTION

SELECTING THE ROOM

- Install the appliance in a dry and well ventilated room. The appliance will operate correctly if the environment temperature is in the interval specified in the table. The appliance class is indicated on the rating plate / label with the basic information on the appliance.

Class	Temperature
SN (subnormal)	from +10°C to +32°C
N (normal)	from +16°C to +32°C
ST (subtropical)	from +16°C to +38°C
T (tropical)	from +16°C to +43°C

Warning: Make sure the room where the appliance is installed is large enough. There should be at least 1 m³ of space per 8 grams of refrigerant. Amount of refrigerant is stated on the rating plate in the appliance interior.

INSTALLING THE APPLIANCE

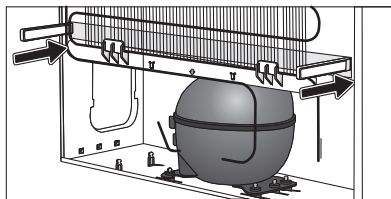
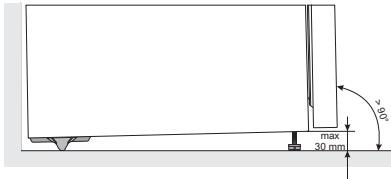

Appliance installation should be carried out by at least two persons to avoid any physical injury or damage to the appliance.

- The appliance must stand level or tilted slightly to the back, stable on a solid base. At the front, the appliance is fitted with two adjustable legs that can be used to level the appliance. At the rear side, casters allow for easier installation of the appliance (only with some models).
- There should be a clearance of at least 5 cm between the appliance and any cupboard installed above it, in order to allow adequate cooling of the condenser unit.
- The appliance is supplied with two spacers which should be installed on the lower part of the housing to prevent from pushing the appliance too close to the wall. Appliance may also be installed without the spacers; however, this may increase power consumption.
- Do not expose the appliance to direct sunlight and do not place it near any source of heat. If this cannot be avoided, install an insulation panel.

- The appliance may stand alone or it may be placed ext to a cupboard or a wall. Consider the clearance required to fully open the door in order to allow pulling out the drawers and shelves (see installation diagram).

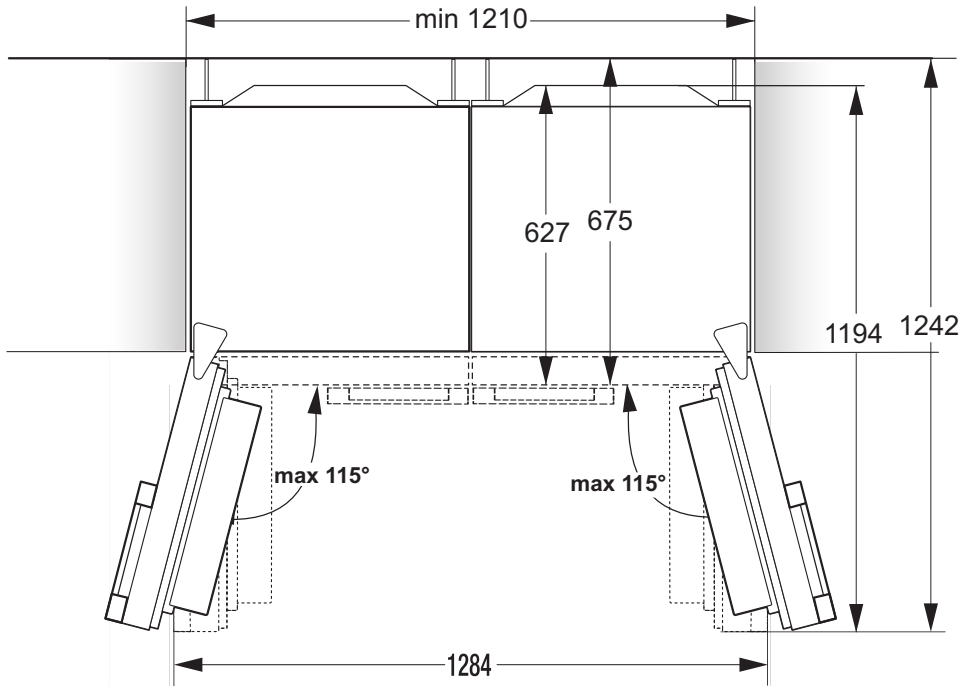

Side-by-side installation: We recommend leaving the side-by-side installation of two appliances to a service technician. If you decide to do this yourself, observe the instructions supplied with the side-by-side installation kit.

CONNECTING THE APPLIANCE

- Connect the appliance to the power mains using a connection cable. The wall outlet should be fitted with a ground contact (safety socket). Nominal voltage and frequency are indicated on the rating plate/label with basic information on the appliance.
- The appliance must be connected to the power mains and grounded in compliance with the effective standards and regulations. The appliance will withstand short-term deviations from the nominal voltage, but not more than +/- 6%.

CHANGING THE DIRECTION OF DOOR OPENING

Tools required: socket wrench No. 8, Phillips screwdriver, torx 25, flat screwdriver

The procedure to change the direction of door opening should be carried out by at least two persons.

1. Remove the upper hinge cover (A).
2. Unscrew the upper hinge (B) and remove the upper door (C).
3. Then remove the covering plugs (D), unscrew the mid hinge (E) and remove the lower door (F) from the lower hinge (G).
4. Tilt the appliance backwards (make sure you do not press against the condenser unit on the rear wall of the appliance as this may damage the cooling system), unscrew the lower hinge (G) and the foot (H) and move them to the opposite side. Make sure the washer is installed like it was before disassembly.
5. Move the door hinges (I) to the opposite side. Remove the door stopper S1 and attach the door stopper S2 supplied in a bag with the instruction manual.
6. Place the middle hinge (E) on the lower door (F) and place the lower door on the lower hinge (G). Fasten the mid hinge (the door should be open while you do this). Do not forget to place the washers (J) and covering plugs (M) as they were placed before the disassembly.
7. Place the upper door (C) over the middle hinge (E), remove the covering cap (K) and fasten the upper hinge (B).
8. Install the upper hinge cover (A) and the covering cap (K).
9. Replace the handle (L): undo the side screws (M) and the (N) screw in the handle holder. Take care not to damage the door. Pull the handle in the direction of the arrow
Disassemble the handle (L): undo the screw (O), turn the handle holder (P) by 180° and reattach it using the screw. On the opposite side of the door, remove the cover plugs (R) and replace the handle (L) in the direction of the arrow 2. Reattach the handle using the screws (M) and (N). Place the covering plugs/caps (R) on the opposite side of the door.

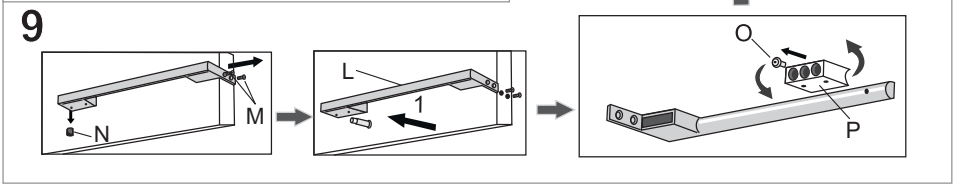
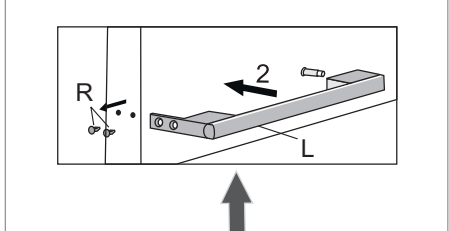
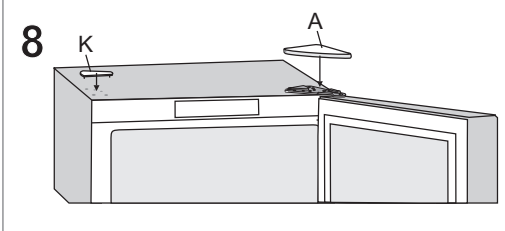
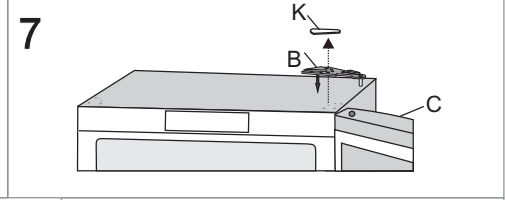
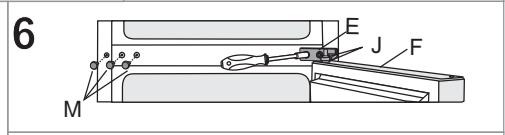
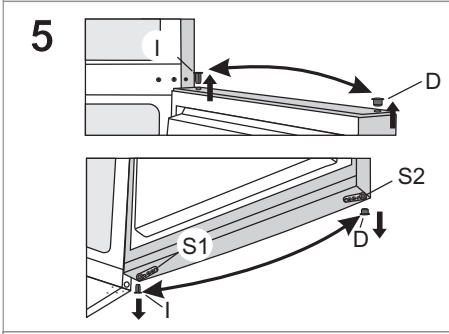
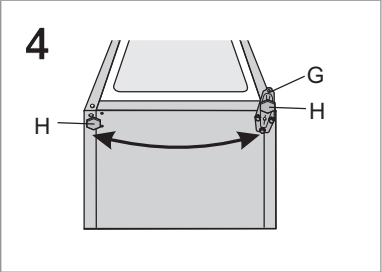
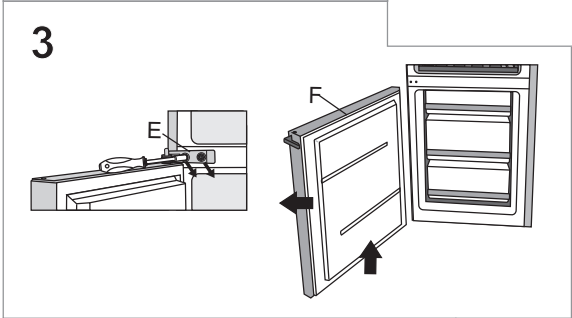
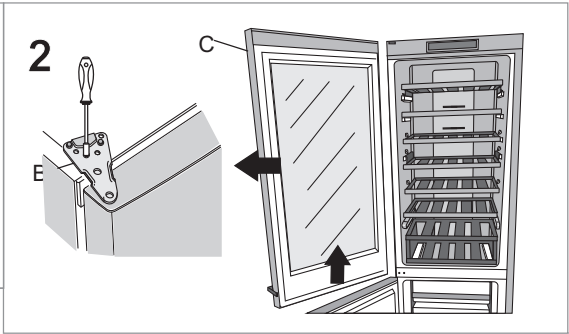
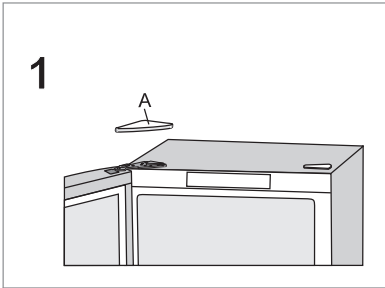

OPERATING THE APPLIANCE

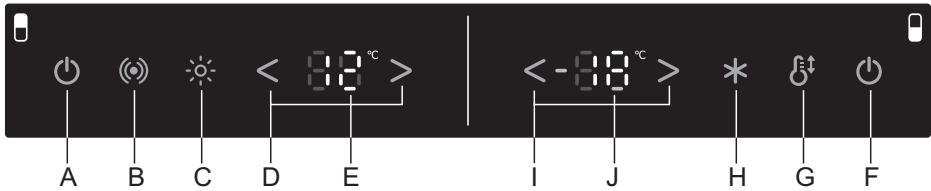

- A Appliance on key and wine cooler off key
- B Acoustic alarm off key
- C Lighting on/off key
- D Wine cooler temperature setting keys
- E Wine cooler set temperature display
- F Freezer compartment on key and appliance off key
- G Freezer/ZeroZone switch key
- H Freezer boost on/off key (when the freezer compartment operates in the ZeroZone mode, the H key has no function)
- I Freezer/ZeroZone compartment temperature setting keys
- J Freezer/ZeroZone compartment set temperature display

SWITCHING THE APPLIANCE ON/OFF

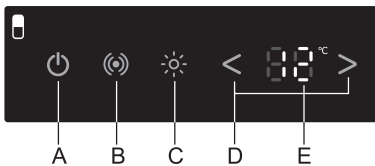

Switching the appliance on: Switch on the appliance by briefly pressing the **A** key.

With this model, it is possible to only switch on the freezer compartment while the wine cooler compartment is switched off. This setting can be made in two ways:

- Briefly press the **F** key to switch on the freezer compartment only. Or
- First briefly press the **A** key to switch on the entire appliance. Then, press and hold (for three seconds) the **A** key to switch off the wine cooler.

When the **A** key is pressed again, the wine cooler compartment will be switched back on.

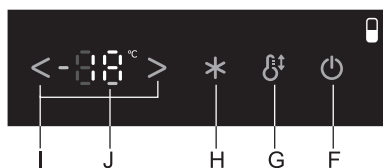

Switching off the appliance: To switch off the appliance, press and hold (for three seconds) the **F** key (caution: appliance will remain powered, i.e. there will still be electric current in the appliance).

ADJUSTING THE TEMPERATURE IN THE APPLIANCE

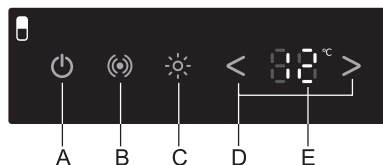

- To set the temperature in the freezer compartment, use the **D** keys.
 - < lower temperature;
 - > higher temperature
- Temperature in the wine cooler can be set in the range from +1 °C to +19 °C (or from +4 °C to +19 °C if the **ZeroZone** compartment is activated with the **G** key).

- Temperature in the wine cooler cannot be higher than the temperature of the room in which the appliance is installed!
- Press the left **D** key to decrease the temperature setting by 1 °C. Press the right **D** key to increase the temperature setting by 1 °C. A short beep will be heard every time a key is pressed.
- After one of the **D** keys is pressed, the most recent temperature setting will flash on the display unit **E**. Use the **D** keys to set the desired temperature. Three seconds after the last key was pressed, the most recent temperature setting is stored for the wine cooler compartment.
- **Recommended temperature setting for storing red wine is:** light red wines and roses at 12 °C; medium and full-bodied red wines at 17 to 19 °C.
- **Recommended temperature setting for storing white wine is:** Sparkling and dessert wines at 6 to 8 °C; light white wines at 10 °C.

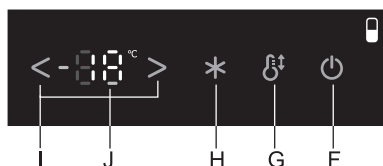

- Set the temperature in the freezer compartment using the **I** keys.
 - < lower temperature;
 - > higher temperature
- Temperature in the **freezer compartment** can be set in the range from -24 °C to -16°C (or from -2 °C to +3 °C if the **ZeroZone** compartment is activated with the **G** key).
- Press the left **I** key to decrease the temperature setting by 1 °C. Press the right **I** key to increase the temperature setting by 1 °C. A short beep will be heard every time a key is pressed.

- After one of the **I** keys is pressed, the most recent temperature setting will flash on the display **J**. Use the **I** keys to set the desired temperature. Three seconds after the last key was pressed, the most recent temperature setting is stored for the freezer compartment.
- Recommended temperature setting is -18 °C.

INTENSIVE FREEZING (FREEZER COMPARTMENT)

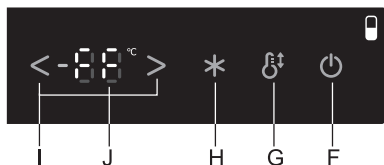

- Use this setting after switching on the appliance for the first time, before cleaning, or 24 hours before inserting a large amount of food.

Switching on the freezer boost (super freeze) function: Press the **H** key. **FF** will appear on the display. The **H** key will remain lit as long as the freezer boost function is activated.

If any other setting is made while the freezer boost function is activated, the function will be immediately deactivated.

If the freezer boost is not deactivated manually, it will be automatically switched off after approximately 2 days. Then the temperature of the freezer compartment will return to the most recently set value.

EXTREME FREEZING (UPPER DRAWER OF THE FREEZER COMPARTMENT)

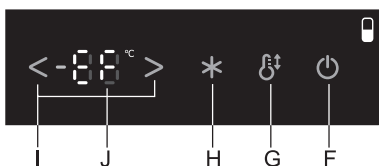

- In order to quickly freeze fresh food, use the **XtremeFreeze** function that is only active in the upper drawer of the freezer compartment. It involves intensive blowing of cool air in that part of the appliance. Faster freezing will retain more vitamins, minerals, and nutrients in the food for a longer period of time.

Switching on the freezer boost (XtremeFreeze) function: Press the **H** key and hold it for at least 3 seconds. **EF** will appear on the display **J**.

- With this setting, the compressor will operate continuously and the temperature in the freezer compartment will drop considerably.
- If the setting is not deactivated manually (by pressing the H key), it will be deactivated automatically after approximately one day. Freezer compartment temperature will return to the most recent setting.
- Use this setting for freezing smaller amounts of food (up to 2 kilograms) in the upper drawer. When freezing a large amount of food, the setting should be activated 12 hours before inserting the food in the freezer.

CONTROLLING THE ZEROZONE COMPARTMENT

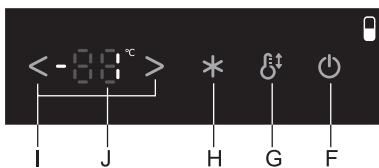

- The entire freezer compartment can be turned into a **ZeroZone** compartment. The temperature in this compartment is around 0 °C. Therefore, do not store food that is sensitive to low temperature in this compartment as such food may freeze. Before switching to **ZeroZone** function, empty the freezer compartment to prevent the frozen food from defrosting and perishing.

- **Switching the ZeroZone on/off:** Press the **G** key and hold it for 5 seconds. When activated, the **G** key will be lit up.
- **Setting the temperature in the ZeroZone:** press the **I** keys to set the temperature between -2 °C and +3 °C.
- **ZeroZone may operate even when the refrigerator compartment is switched off.** After switching from freezer to **ZeroZone** function, it may be necessary to wait a few hours for the temperature to increase to the set value. The display **J** will flash during this time.
- The temperatures are approximate and they depend on the temperature settings in the refrigerator compartment, environment temperature, frequency of door opening, and amount of food inserted. Higher temperatures in the **ZeroZone** compartment lead to higher temperatures in the refrigerator compartment, and vice versa. Adjust the setting to the operating conditions.
- If the bottom compartment functions as a **ZeroZone**, the temperatures in the refrigerator compartment can only be set in the range from +4 °C to +19 °C. We recommend such use only when environment temperature is between +16 °C and +32 °C. At higher or lower temperatures, it is not possible to guarantee adequately low temperatures in the appliance.

APPLIANCE LIGHTING

- Lighting in the entire wine cooler compartment is switched on every time you open the door, and it is switched off every time you close the door, except in the special operating mode described below.
- Press the **C** key to activate the continuous LED lighting for the entire wine cooler compartment. In this mode, LED lighting will not be switched off when you close the door, but will rather remain active until switched off manually, i.e. until you press the C key again.
If continuous LED lighting is not switched off manually, then it will be switched off automatically after five hours.

HIGH TEMPERATURE ALARM

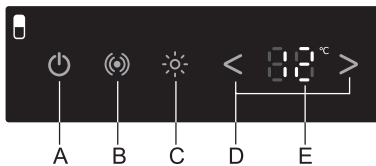

If the temperature inside the appliance is too high, acoustic alarm will be activated (**intermittent tone**) and the **B** key will flash. Moreover, flashing **J** or **E** display will indicate the compartment for which the high temperature alarm was activated.

- The acoustic alarm will be sounded for the first five minutes of every hour until the appliance reaches a suitable temperature.

- The acoustic alarm will be activated every 24 hours if the temperature in the appliance is not low enough and there is danger of food spoilage. The alarm will be switched off automatically as soon as the temperature in the freezer drops to a level that no longer presents spoilage hazard.
- When the appliance is switched on for the first time, there is a 24-hour delay in temperature alarm operation since the appliance will not have reached the adequate temperature. Thus, unnecessary activation of alarm is prevented.

Open door alarm: if the wine cooler or freezer compartment door is open for more than 2 minutes, acoustic alarm will be activated and the **B** key will flash. When the door is closed, the alarm will be deactivated. It can also be switched off by pressing the **B** key.

SAFETY BLOCK (CHILD SAFETY LOCK)

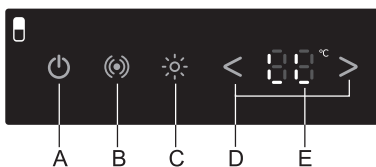

Use this function to prevent any inadvertent changes to appliance settings.

To activate, press and hold the **B** key (for three seconds); **LL** will appear on the display **E**.

This will lock every key except **B**. To deactivate the child safety lock, press the **B** key again and hold it for three seconds.

APPLIANCE INTERIOR EQUIPMENT

(* Equipment depends on the model)

BOTTLE SHELVES

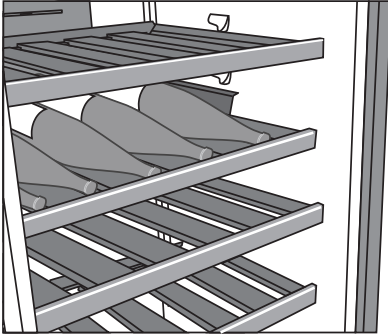

- The shelves are intended for storing bottles.
- Maximum load on each shelf is 13 kg.

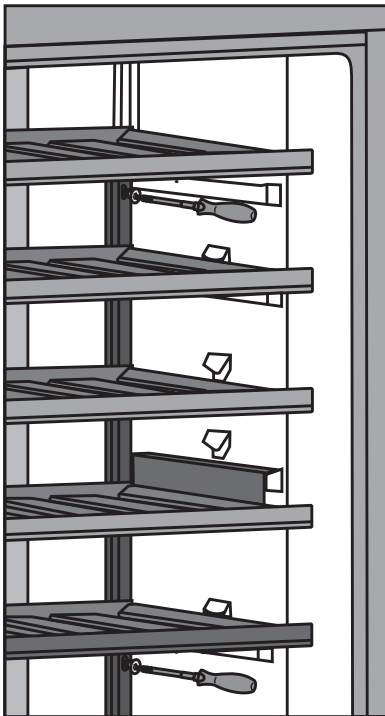

Shelf removal: The shelves are secured in place with a rail. When removing the shelf, unscrew the two screws on the rail, which is installed on the right side in the back of the appliance, behind the shelves.

When the two screws are removed, lightly lift the back of the shelf and pull it out.

Note: Loaded shelves should always be fixated with rail to prevent removal.

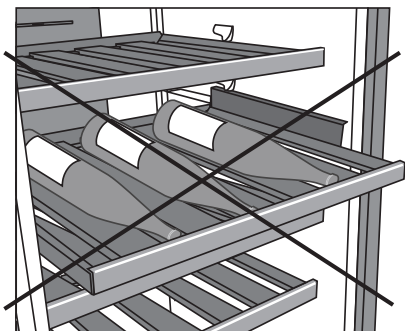

Note: The shelf is not intended to be partially pulled out. Therefore, do not pull out a full shelf from the appliance.

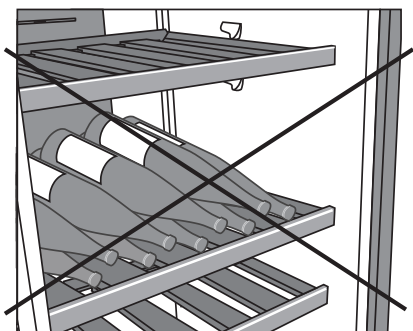

Note: Do not stack bottles on the shelf in several layers.

BOTTLE CASE

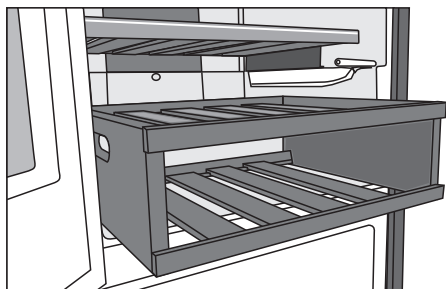

- There is a bottle case at the bottom of the wine cooler compartment. It is intended for storing bottles and to transport them from the appliance or into the appliance.
- Use the handles on either side to transport the case.
- Avoid overloading the case as this may cause injury in case of falling or any other accident.

ADAPTIVE INTELLIGENT TECHNOLOGY

Innovative sensor technology allows adjusting appliance operation to the user's habits or behaviour. Adaptive intelligent system monitors, analyzes, and records on a daily and weekly basis the use of appliance and adapts appliance operation to the perceived patterns. If the appliance is able to anticipate increased frequency of door opening, the appliance will automatically lower the temperature before such time to prevent the increase of food temperature as the door is opened more often. The appliance will also anticipate adding larger amounts of food into the refrigerator or freezer and adapt by cooling or freezing more intensively.

STORING FOOD IN THE ZEROZONE COMPARTMENT

The **ZeroZone** compartment allows storing a wide variety of fresh food to keep up to three times longer than in a conventional refrigerator. The food stays fresh longer, retaining the flavour and nutrients.

- When buying food, make sure it is fresh as this will determine the quality of the food, as well as how long it will keep in the fridge.
- Store the food in closed containers or appropriate packaging to prevent it from emitting or receiving odours.
- Take the food from the drawer 30–60 minutes before use to allow the aroma and flavour develop at room temperature.
- Food sensitive to low temperature and therefore not appropriate for storage in the **ZeroZone** drawer includes the following: pineapple, avocado, bananas, olives, potatoes, eggplant, cucumbers, beans, peppers (capsicum), melons, watermelons, pumpkins and squash etc.

APPROXIMATE STORAGE TIME IN THE ZEROZONE COMPARTMENT*

Type of food	Time
sausages, cold cuts, beef, pork, venison, raw meat	up to 7 days
Poultry	up to 5 days
fish	up to 4 days
seafood	up to 3 days
Vegetables:	
cabbage, garlic, carrots	up to 180 days
celery, herbs	up to 30 days
Green lettuce, cauliflower, radicchio, rhubarb	up to 21 days
broccoli, asparagus, kale, Chinese cabbage, kohlrabi, radish	up to 14 days
onions, mushrooms, spinach, peas	up to 7 days
Fruit:	
apples	up to 180 days
pears, kiwi	up to 120 days
grapes, quinces	up to 90 days
peaches	up to 30 days
redcurrant, gooseberries, plums	up to 21 days
apricots, blueberries, cherries	up to 14 days
raspberries, strawberries	up to 3-5 days
Other:	
milk	up to 7 days
butter	up to 30 days
cheese	up to 30 days

* depending on the quality and freshness of food

FREEZING AND STORING FROZEN FOOD

FREEZING PROCESS



Maximum amount of fresh food that may be inserted at once is specified on the appliance rating plate. If the amount of food to be frozen exceeds the indicated amount, the quality of freezing will be inferior; in addition, the quality of the food already frozen will deteriorate.

- To make use of the entire freezer volume, remove all drawers. Place the food directly on the shelves and on the freezer bottom.
- Activate the super freeze function 24 hours before freezing fresh food:
 - press the **H** key.

After this time, insert the fresh food into the freezing compartment.

Make sure the fresh food is not in contact with the food that is already frozen!
The most suitable place for freezing a large amount of fresh food is the upper section of the freezer.

- When freezing smaller quantities of food (1-2 kilograms), activating the super freeze function is not required.
- After 24 hours, the food can be moved to other freezer compartments and the freezing process can be repeated as necessary.

IMPORTANT WARNINGS ON FREEZING FRESH FOOD



Only freeze the food that is suitable for freezing in the freezer. Make sure the food you freeze is of high quality and fresh.

Choose appropriate packaging and use the packaging correctly.

Packaging should not be permeable to humidity; it should be airtight to prevent the food from drying out and loss of vitamins.

Label the food; indicate the type of food, amount, and date of freezing.

It is important that the food is frozen as quickly as possible. Therefore, keep the packages small. Refrigerate the food before freezing.

STORAGE OF INDUSTRIALLY FROZEN FOOD

- When storing and using frozen food, observe the manufacturer's instructions. Temperature and expiry date are indicated on the packaging.
- Only choose food with undamaged packaging, stored in freezers at temperatures of -18 °C or lower.
- Do not purchase food covered in frost as this indicates they have been partly defrosted several times and that they are of inferior quality.
- Protect the food from thawing during transport. In case of an increase in temperature, storage time will be shorter and quality will deteriorate.

FROZEN FOOD STORAGE TIME

RECOMMENDED STORAGE TIME IN THE FREEZER

Type of food	Time
fruit, beef	from 10 to 12 months
vegetables, veal, poultry	from 8 to 10 months
Venison	from 6 to 8 months
Pork	from 4 to 6 months
minced meat	4 months
bread, pastry, ready-to-eat meals, lean	3 months
entrails	2 months
smoked sausage, fatty fish	1 month

DEFROSTING FROZEN FOOD

Freezing the food does not kill the microorganisms. After the food is defrosted or thawed, bacteria is re-activated and the food spoils quickly. Use the partially or completely defrosted food as soon as possible.

Partial thawing decreases the nutritive value of the food, particularly fruit, vegetables, and ready-to-eat food.

DEFROSTING THE APPLIANCE

AUTOMATIC REFRIGERATOR DEFROSTING

Refrigerator does not need defrosting because the ice on the back interior wall is thawed automatically.

Any accumulated ice will melt when the compressor unit is inactive. Drops will flow through an opening in the refrigerator rear wall into a tray fitted above the compressor, from where they will evaporate.

If an excessive layer of ice is formed on the rear wall of refrigerator interior (3-5 mm), switch off the appliance and defrost the appliance manually.

DEFROSTING A NO FROST FREEZER

- The NO FROST freezer will defrost automatically. Occasional frost that may appear on the walls will disappear automatically.
- Build-up of ice or frost in the freezer compartment can be a result of abnormal use of appliance (door opened too frequently and/or too long, door not properly closed etc.). In this case, unplug the appliance, remove the food from the freezer and protect them from defrosting.

Clean and dry the freezer interior. Before returning the frozen food into the freezer, switch on the appliance and select the desired setting.

CLEANING THE APPLIANCE

Before cleaning, unplug the appliance from the power mains – switch off the appliance (see chapter Switching the Appliance On/Off) and unplug the power cord from the wall outlet.

- Use a **soft cloth** to clean all surfaces. Cleaners that contain **abrasive substances, acids, or solvents are not suitable for cleaning** as they may damage the surface.

Clean the appliance **exterior** with water or a mild solution of suds. Lacquer-coated and aluminium surfaces may be cleaned with lukewarm water to which you have added a mild detergent. Use of cleaners with low alcohol content is allowed (e.g. window cleaners). Do not use cleaners containing alcohol for cleaning plastic materials.

Appliance interior can be cleaned with lukewarm water to which you can add some **vinegar**.

Cleaning the wooden parts: Clean the wooden parts with a damp cloth. Make sure the wood does not get too wet.

Warning: Wood is a natural material. Therefore, some stains may be difficult to remove (especially red wine or oil).

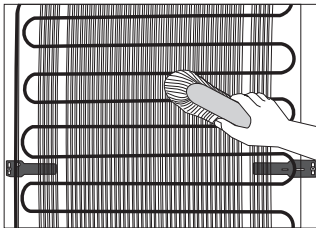

- The **condenser** unit mounted on the (exterior) back wall should always be kept clean, free of dust or deposits resulting from kitchen smoke or fumes.. Occasionally clean the dust using a soft non-metal brush or a vacuum cleaner.
- After cleaning, switch the appliance back on and insert the food.

TROUBLESHOOTING

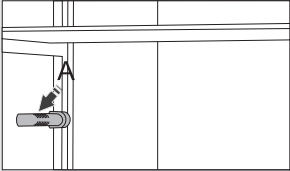
Problem:	Cause or remedy:
Appliance is connected to the power mains but it does not work.	<ul style="list-style-type: none"> • Make sure there is voltage in the power outlet and that the appliance is switched on.
Cooling system operates continuously for a long period of time: 	<ul style="list-style-type: none"> • Too high environment temperature. • Door opened too frequently or too long. • Door not closed correctly (possible impurities on the seal, misaligned door, damaged seal etc.). • Too much fresh food inserted at once. • Sensor in the refrigerator (A) blocked by fresh food. Make sure the air can circulate around the sensor (only with some models). • Insufficient compressor and condenser cooling. Check the air circulation behind the appliance and clean the condenser unit.
Excessive build-up of ice on the back wall of refrigerator interior can be a result of the following:	<ul style="list-style-type: none"> • Door opened too frequently or too long. • Warm food placed in the refrigerator. • Food in contact with the back interior wall of the refrigerator. • Poor door sealing. • If the seal is dirty or damaged, clean it or replace it.
Build-up of ice or frost in the freezer interior may be a result of the following:	<ul style="list-style-type: none"> • Door opened too frequently or too long. • Door not properly closed. • Poor door sealing. • If the seal is dirty or damaged, clean or replace it.
Water leaking from the refrigerator:	<ul style="list-style-type: none"> • Clogged water discharge opening or water dripping past the water gutter. • Clean the clogged opening, for example using a plastic straw. • If a thick layer of ice builds up, defrost the appliance manually (see Defrosting the Appliance).
The B key will flash:	<ul style="list-style-type: none"> • Door opened too frequently or too long. • Door not closed correctly (possible impurities on the seal, misaligned door, damaged seal etc.). • A longer power failure. • Too much fresh food inserted at once.
Door is difficult to open:	<ul style="list-style-type: none"> • If you are trying to open the freezer door after just having closed it, this could be difficult to do. As you open the door, some cool air escapes from the appliance and it is replaced by warm air from the environment. When this air is cooled, negative pressure is generated which results in problems as you try to open the door. After a few minutes, the condition is normalized and the door can be easily opened again.

Problem:	Cause or remedy:
LED lighting does not work:	<ul style="list-style-type: none"> • If LED lighting does not work, call a service technician. • Do not attempt a repair of the LED lighting yourself, as there is danger of contact with high voltage!
Indication of error code on the display (only with some models):	<ul style="list-style-type: none"> • If E appears on the display, call a service technician.

If none of the instructions above fixes your problem, call the nearest authorized service center and state the type, model, and serial number found on the rating plate/label which is located in the appliance interior.

INFORMATION ABOUT APPLIANCE NOISE

Cooling in refrigerator freezers is made possible by a cooling system that also includes a compressor (and a fan with some appliances), which generates some noise. The level of noise depends on installation, proper use, and age of the appliance.

- **After connecting the appliance to the power mains**, compressor operation, or the sound of flowing liquid, may be somewhat louder. This is not a sign of malfunction and it will not affect the useful life of the appliance. In time, appliance operation and this noise will become quieter.
- Sometimes, **unusual or loud noise** may appear during appliance operation; these are mostly the result of improper installation:
 - The appliance must stand level and stable on a solid base.
 - The appliance may not be in contact with a wall or adjacent furniture.
 - Make sure the interior equipment sits firmly in its place and that the noise is not caused by cans, bottles or other containers placed next to each other.
- Due to the higher workload on the cooling system when the door is opened more frequently or for a longer time, when a large amount of fresh food is introduced, or when intensive freezing or cooling functions are activated, the appliance can temporarily generate more noise.

WE RESERVE THE RIGHT TO MAKE CHANGES THAT DO NOT AFFECT THE FUNCTIONALITY OF THE APPLIANCE.

ASKO



577323

en (01-18)