

EN

DETAILED INSTRUCTIONS FOR USE OF A DRYER

gorenje

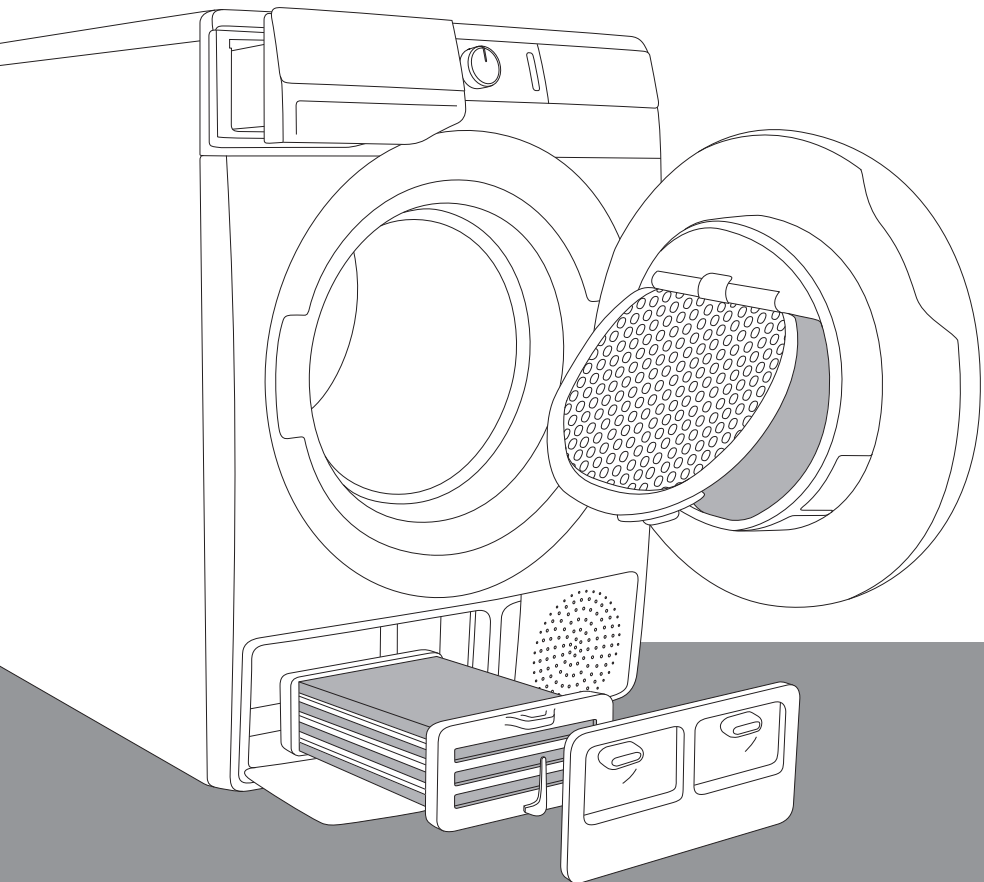

Life is complicated today. Let's make at least laundry care simple! Your new **WaveActive** dryer uses innovative technology and the latest achievements in laundry care to help you simplify your daily household chores. The **WaveActive** technology offers the gentlest care for any garment, with minimum creasing. Moreover, your new dryer is also friendly to the environment as it uses power in the most economical way possible.

This dryer is intended solely for household use. Please do not use it to dry clothes that are not suitable for machine drying.

The following symbols are used throughout the manual and they have the following meanings:



Information, advice, tip, or recommendation



Warning – general danger



Warning – danger of electric shock



Warning – danger of hot surface



Warning – danger of fire



It is important that you carefully read the instructions.

SAFETY PRECAUTIONS



Carefully read the instructions for use before using the dryer.

Please, do not use the dryer without reading and understanding these instructions for use first.

These instructions for use of a dryer are supplied with different types or models of dryers. Therefore, they may include descriptions of settings or equipment that are not available in your dryer.

Failure to observe the instructions for use or inappropriate use of the dryer may result in damage to the laundry or the appliance, or injury to the user. Keep the instruction manual handy, near the dryer.

Instructions for use are available on our website at www.gorenje.com.

Your dryer is intended solely for household use. If the dryer is used for professional, for-profit purpose or purpose exceeding normal use in a household, or if the dryer is used by a person who is not a consumer, the warranty period shall be equal to the shortest warranty period required by relevant legislation.

Follow the instructions for correct installation of the Gorenje dryer and connection to the power mains (see chapter »INSTALLATION AND CONNECTION«).

All and any repairs or maintenance tasks on the dryer should only be done by trained experts. Unprofessional repair may result in an accident or major malfunction.

To avoid danger, a **damaged power cord** may only be replaced by the manufacturer, a service technician, or an authorized person.

After installation, the dryer should stand still for two hours before it is connected to the power mains.

At least two persons are required to install the tumble dryer on top of a washing machine.

The dryer may not be connected to the power mains using an extension cord.

Do not connect the tumble dryer to an electrical outlet intended for an electric shaver or a hair dryer.

Do not connect the dryer to power mains using an external switching device such as a programme timer, or connect it to power mains that is regularly switched on and off by the power supply provider.

In case of a defect, only use approved spare parts by authorized manufacturers.

In case of incorrect dryer connection, incorrect use, or servicing by an unauthorized person, the user shall bear the cost of any damage as such damage shall not be covered by warranty.

Always use the ducts or hoses supplied with the dryer.

Install the dryer in a room with adequate ventilation and a temperature between 10°C and 25 °C.

Place the dryer on a level and stable solid (concrete) base.

Do not place the dryer behind lockable or sliding door, or door with a hinge on the opposite side of the dryer door hinge. Install the dryer in such way that the door can always be freely opened.

Never block the air exhaust (evacuation opening).

Do not place the dryer on a carpet with long fibres as this may impede air circulation.

Air in the dryer environment should not contain dust particles. The air where the dryer is installed should be thoroughly ventilated to prevent reverse flow of gases released from the gas appliances with open fire (e.g. a fireplace).

Make sure the fibres do not accumulate around the dryer.

The appliance may not be in contact with a wall or adjacent furniture.

Do not use the dryer to dry any laundry that has not been washed.

Laundry stained with oil, acetone, alcohol, oil derivatives, stain removers, turpentine, wax, and wax removers should be washed in a washing machine with hot water and detergent before it is dried in the dryer.

Clothing that includes latex, rubber parts, shower and bathing caps, and laundry or covers with rubber foam may not be dried in the dryer.

Use laundry conditioners or similar products in compliance with manufacturer's instructions.

 Remove all objects such as lighters and matches from the pockets.

If the condensate tube is blocked or clogged, then tumble dryer operation is stopped (see chapter »PAUSING AND CHANGING THE PROGRAMME/Full condensate tank«).

Before moving the dryer or before storing it in a non-heated room during the winter, the condensate tank has to be emptied.

Clean the dryer filter after each drying cycle. If you have removed the filter, replace it before the next drying cycle.

After each cleaning cycle, replace the condenser unit into the air duct. Dryer operation without the condenser unit or with a damaged condenser unit is hazardous and could result in a fire (see chapter »DESCRIPTION OF THE DRYER and CLEANING THE CONDENSER UNIT«).

Do not use any solvents or cleaning agents that could damage the dryer (please observe the recommendations and warnings provided by the manufacturers of the cleaning agents).

Never add chemicals or fragrances into the condensate tank (see chapter »DESCRIPTION OF THE DRYER and EMPTYING THE CONDENSATE TANK«).

After the drying process, unplug the dryer power cord from the power outlet.

The dryer is not intended for use by persons (including children) with physical or mental impairments, or persons with lacking experience and knowledge. These persons should be instructed about the use of the dryer by a person responsible for their safety.

The warranty does not cover consumables, minor deviations in colour, increased noise that results from appliance age and which does not affect the functionality of the dryer, and aesthetic defects on components, which do not affect the dryer's functionality and safety.

CHILD SAFETY

Do not allow children to play with the dryer.

Prevent your children and pets from entering the dryer drum.

Before closing the dryer door and running the programme, make sure there is nothing except laundry in the drum (e.g. if a child climbed into the dryer drum and closed the door from the inside).

Activate the child lock. See chapter »STEP 4: SETTING THE EXTRA FUNCTIONS/Child lock«.

Do not let children younger than three years to come near the tumble dryer, unless they are under constant supervision.

The dryer is made in compliance with all relevant safety standards.

This dryer may be used by children aged 8 years and above and by persons with reduced physical, sensory or mental capabilities or lack of experience and knowledge, but only if they are supervised during the use of the appliance, if they have been provided relevant instructions regarding safe use of the dryer, and if they understand the hazards of inappropriate use. Make sure children do not play with the dryer. Children may not clean the dryer or perform any maintenance tasks without supervision.

DANGER OF HOT SURFACE

The back of the dryer may get very hot during operation. Wait for the dryer to cool down completely before touching its back side.

If you open the dryer door during the drying process, the clothes may be very hot and there is a risk of burning.

Never stop the drying process before it is completed; if you do interrupt the cycle for any reason, be careful when removing the laundry from the drum as it is very hot. Quickly remove the laundry from the drum and spread it to allow it to cool down as quickly as possible.

SAFETY

 Only use the dryer to dry laundry that was washed with water. Do not dry any laundry that was washed or cleaned with flammable cleaners or substances (such as gasoline, trichloroethylene etc.) as this may result in an explosion.

If you have cleaned your clothes with industrial cleaners or chemical substances, **do not dry** them in the dryer.

The dryer is protected with an automatic switch-off system in case of overheating. This system will switch off the dryer if the temperature is too high.

If the net filter is clogged, the overheating automatic switch-off system may be activated. Clean the filter, wait for the dryer to cool down, and try running it again. If the dryer still fails to start, call a service technician.

DESCRIPTION OF THE DRYER

FRONT

- 1 Condensate tank
- 2 On/off button
- 3 Programme selector knob
- 4 Start/pause button
- 5 Control unit
- 6 Door
- 7 Net filter
- 8 Air vent
- 9 Condenser unit
- 10 Rating plate

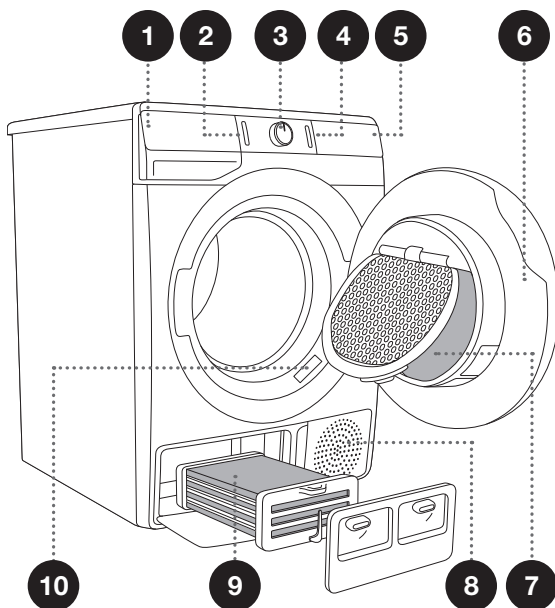

BACK

- 1 Power cord
- 2 Condensate discharge hose
- 3 Adjustable feet

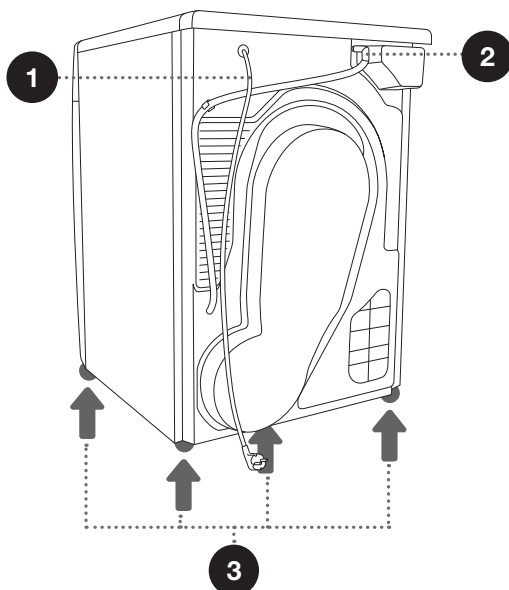

TECHNICAL INFORMATION

(DEPENDING ON THE MODEL)

Rating plate with basic information about the dryer is fitted on the front wall of the dryer door opening (see chapter »DESCRIPTION OF THE DRYER«).

Width	600 mm
Height	850 mm
Dryer depth (a)	625 mm
Depth with door closed	653 mm
Depth with door open (b)	1134 mm
Weight	XX/YY kg (depending on the model)
Rated voltage	See rating plate
Fuse	See rating plate
Nominal power	See rating plate
Maximum load	See rating plate

Rating plate

gorenje	TYPE: SP15/XXX	MODEL: XXXXXX/X	MADE IN SLOVENIA	
	Art.No.: XXXXXX	Ser.No.: XXXXXXXX		IPX4
	220-240 V ~ XX Hz ⚡ XX A			CE
	Pmax.: XXXX W  XXXX W	(X kg)		

CONTROL UNIT

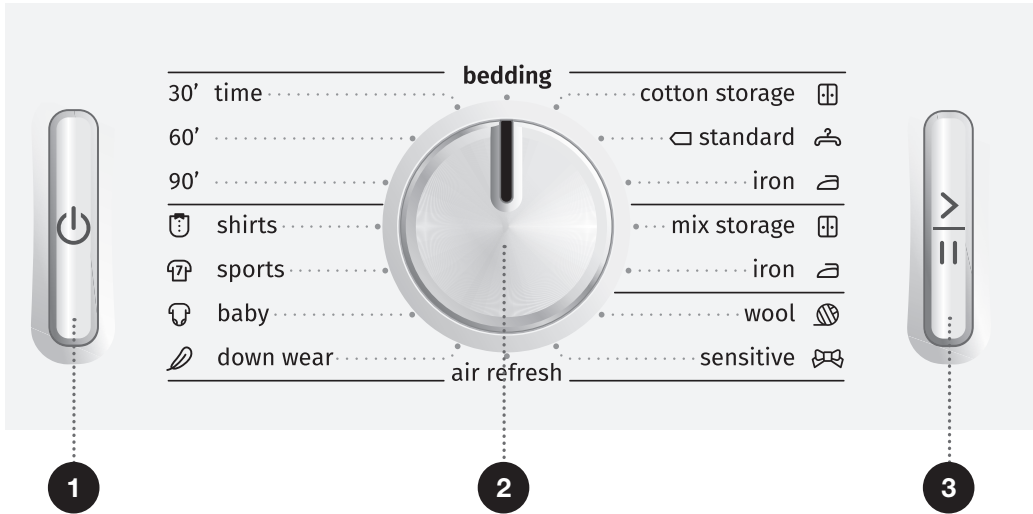

1 ON/OFF BUTTON
Switching the dryer on and off.

2 PROGRAMME SELECTOR KNOB

3 START/PAUSE BUTTON
Use this button to start or stop the programme.

Upon start-up or during pause, the button light will flash; when the programme is started and in progress, it will be lit continuously.

GENTLECARE



extra dry



6



start delay



7



8

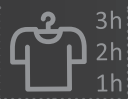

anti crease

10

4 EXTRA DRY
Lighting of the ☀ symbol
when the function is selected

5 GENTLE CARE (LOWER TEMPERATURE)

6 CHILD LOCK  symbol
lighting
Press the positions 4+7 and
hold them for 3 seconds.

7 START DELAY
Option to set a start delay

8 CLEAN THE FILTER 
symbol lighting

9 EMPTY THE CONDENSATE TANK 
symbol lighting

10 ANTI CREASE
Lighting of the symbol
 and anti-crease time.

INSTALLATION AND CONNECTION

⚠ Remove all packaging. When removing the packaging, make sure not to damage the dryer with a sharp object.

SELECTING THE ROOM

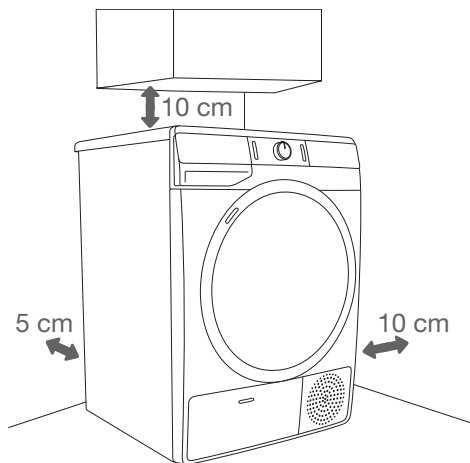

⚠ The dryer may not be in contact with a wall or adjacent furniture. For optimum dryer operation, we recommend observing the clearance from the walls as indicated in the figure. In case of failure to heed the required minimum clearance, the dryer may overheat.

⚠ Vents on the back wall and the air exhaust opening on the front side of the dryer should never be obstructed.

The room in which you will install the dryer should be sufficiently ventilated, with a temperature between 10°C and 25°C. Dryer operation at a lower environment temperature may result in condensate accumulation in the dryer interior. Do not place the dryer into a place where there is danger of freezing. Frozen water in the condensate tank and pump may damage the dryer.

The dryer emits heat. Therefore, do not place it in a very small room, as the drying process may take longer due to limited amount of available air.

Lighting in the room should be sufficient to allow reading the information on the display unit on the control panel.

DRYER PLACEMENT

If you also have a Gorenje dryer of corresponding (same) dimensions, it can be placed on top of the Gorenje washing machine; in this case, vacuum feet must be used. Alternatively, the dryer can be placed next to the washing machine (figures 1 and 3).

If your Gorenje washing machine is smaller (minimum depth 545 mm) than your Gorenje dryer, then the dryer support has to be purchased extra (figure 2). The supplied vacuum feet must be used; they are designed to prevent the dryer from slipping.

Additional equipment (dryer support (a) and vacuum feet (b) if they are not supplied) are available for purchase at the service units.

The surface on which the appliance is placed should be clean and level.

Gorenje washing machine onto which you intend to place the Gorenje dryer should be able to hold the weight of the Gorenje dryer (see chapter »DESCRIPTION OF THE DRYER/Technical information«).

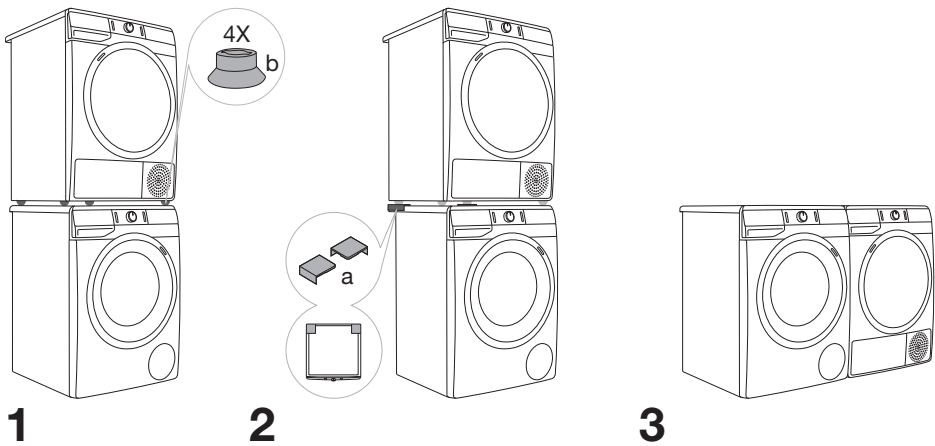

⚠ At least two persons are required to install the tumble dryer on top of a washing machine.

Opening the dryer door (bird's-eye view)

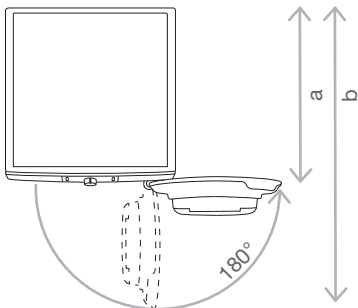

See chapter »DESCRIPTION OF THE DRYER/ Technical information«.

a = 625 mm
b = 1134 mm

 Do not place the dryer behind lockable or sliding door, or door with a hinge on the opposite side of the dryer door hinge. Install the dryer in such way that the door can always be freely opened.

 Do not place the dryer on a carpet with long fibres as this may impede air circulation.

ADJUSTING THE DRYER FEET

Level the dryer in longitudinal and traverse direction by rotating the adjustable feet which allow levelling by +/- 1 cm. Use a spirit level and spanner No. 22.

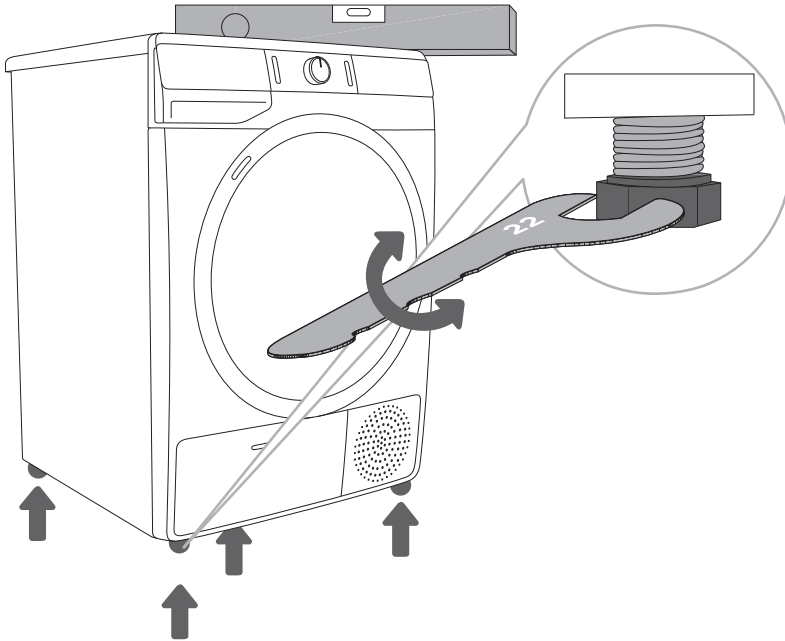

⚠ Floor on which the dryer is placed must have a concrete base. It should be clean and dry; otherwise, the dryer may slide. Also clean the adjustable feet.

⚠ The dryer must stand level and stable on a solid base.

⚠ Incorrect levelling of the dryer with the adjustable legs may cause vibration, appliance sliding across the room, and loud operation. Incorrect levelling of the dryer shall not be subject to warranty.

⚠ Sometimes, unusual or louder noise may appear during appliance operation; these are mostly the result of improper installation.

DRAINING THE CONDENSATE

The moisture from the laundry is extracted in the condenser unit and accumulated in the condensate tank.

During the drying process, an indicator light (symbol  (9) is lit on the display unit) warns when the condensate tank is full and needs to be emptied.

To avoid emptying the condensate tank, run the condensate discharge hose located at the back of the appliance directly into a drain.

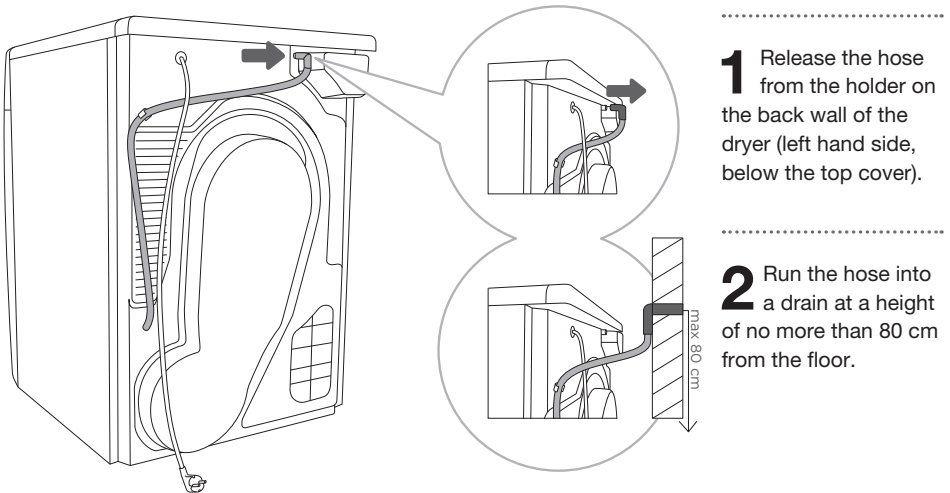

 If you decide to run the condensate drain hose into a drain, make sure the hose is securely fastened. This will prevent any water spillage which could result in unexpected damage.

 Always use the hoses supplied with the dryer.

CONNECTING TO THE POWER MAINS

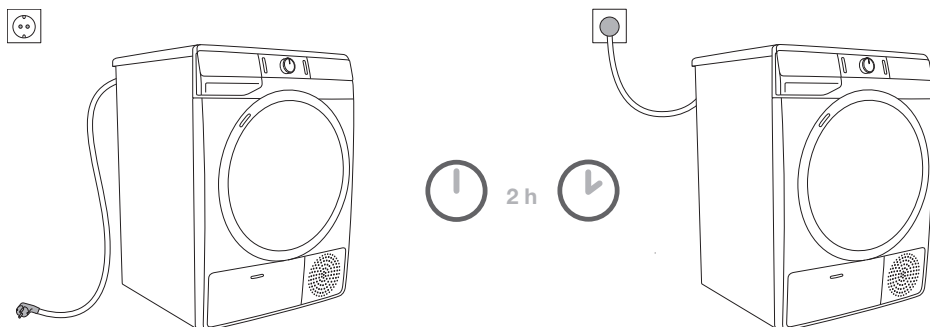

⚠ After installation, the dryer should stand still for two hours before it is connected to the power mains; this allows the dryer to stabilize.

Connect the dryer to a grounded power outlet. After installation, the wall outlet should be freely accessible. The outlet should be fitted with an earth contact (in compliance with the relevant regulations).

Information on your dryer is indicated on the rating plate (see chapter »DESCRIPTION OF THE DRYER/Technical information«).

⚠ We recommend using over-voltage protection to protect the appliance in case of a lightning strike.

⚠ The dryer may not be connected to the power mains using an extension cord.

⚡ Do not connect the tumble dryer to an electrical outlet intended for an electric shaver or a hair dryer.

⚡ Any repair and maintenance pertaining to safety or performance should be done by trained experts.

⚡ A damaged power cord may only be replaced by a person authorized by the manufacturer.

MOVING AND TRANSPORT AFTER INSTALLATION

After every drying cycle, a small amount of condensed water will remain in the dryer. Switch on the dryer and choose one of the programmes, then let the appliance operate for approximately half a minute. This will pump out the remaining water and prevent damage to the dryer during transport.

⚠ After transport, the dryer should be left to stand still for at least two hours before it is connected to the power mains. The appliance should be installed and connected by a trained technician.

💡 If the appliance was not transported in compliance with the instructions, the dryer should be left to stand still at least two hours before it is reconnected to the power mains.

⚠ Carefully read the instructions for use before connecting the dryer. Repair or any warranty claim resulting from incorrect connection or use of the dryer shall not be covered by the warranty.

💡 The belt may only be replaced by a service technician authorized by the manufacturer, who can supply the original spare part with the code OPTIBELT EPH 1906, code 104265; OPTIBELT 8 EPH 1941, code 160165; POLY-V 7PH 1956 HUTCHINSON, code 562038; HUTCHINSON 8 PHE 1942, šifra 270313 (depending on the model).

BEFORE USING THE APPLIANCE FOR THE FIRST TIME

Make sure the dryer is disconnected from the power mains; then, open the door by pulling the left side of the door towards you (figures 1 and 2).

Before using the dryer for the first time, clean the dryer drum using a soft damp cotton cloth and water (figure 3).

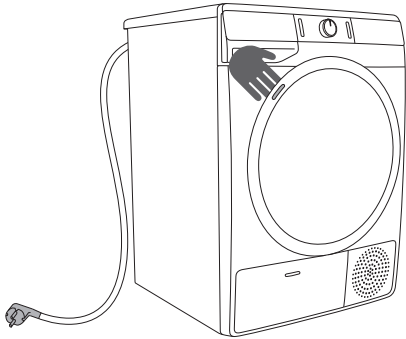

1

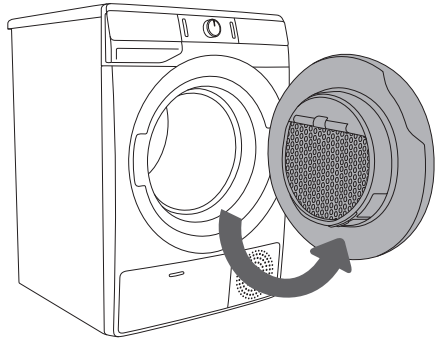

2





























3

 Do not use any solvents or cleaning agents that could damage the dryer (please observe the recommendations and warnings provided by the manufacturers of the cleaning agents).

DRYING PROCESS, STEP BY STEP (1 - 6)

STEP 1: HEED THE LABELS ON THE LAUNDRY

Normal wash; Sensitive laundry	Max. washing temp. 95°C  	Max. washing temp. 60°C  	Max. washing temp. 40°C  	Max. washing temp. 30°C  	Hand wash only 	Do not wash 
Bleaching	Bleaching in cool water 			Bleaching not allowed 		
Dry cleaning	Dry cleaning with all agents 	Petroleum solvent R11, R113 	Dry cleaning in kerosene, pure alcohol, and R113 	Dry cleaning not allowed 		
Ironing	Hot ironing, max. 200°C 	Hot ironing, max. 150°C 	Hot ironing, max. 110°C 	Ironing not allowed 		
Drying	Dry flat (place on a flat surface) 	Drip dry  Line dry 	High temperature  Low temperature 	Do not tumble dry 		

STEP 2: PREPARING FOR THE LAUNDRY DRYING PROCESS

1. Sort the laundry by type and thickness of the fabric (see PROGRAMME TABLE).
2. Close the buttons and zips, tie any ribbons, and turn the pockets inside out.
3. Place very sensitive clothes in a special-purpose laundry bag.
(The special-purpose laundry bag is available as an optional accessory.)

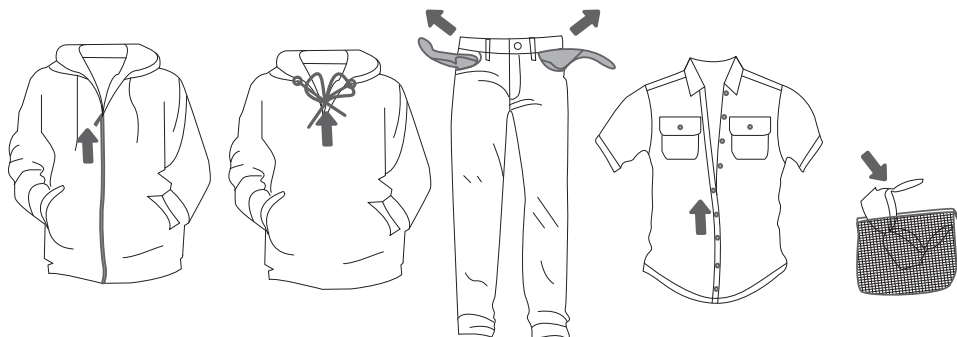

Drying laundry made of particularly delicate fabrics that may be deformed is not recommended. The following types of laundry may not be dried in the dryer as this may cause your garments to deform:

- leather garments and other leather products;
- garments that are waxed or treated in any other way;
- garments with major wooden, plastic, or metal parts;
- garments with spangles;
- garments with metal parts subject to rusting.

DRYING IN A BASKET (DEPENDING ON THE MODEL)

⚠ Before the first drying cycle, remove the basket and all packaging from the drum.

Laundry may only be dried in the basket when using the timed drying programme. (The basket is available for purchase as an optional accessory at the service centre.)

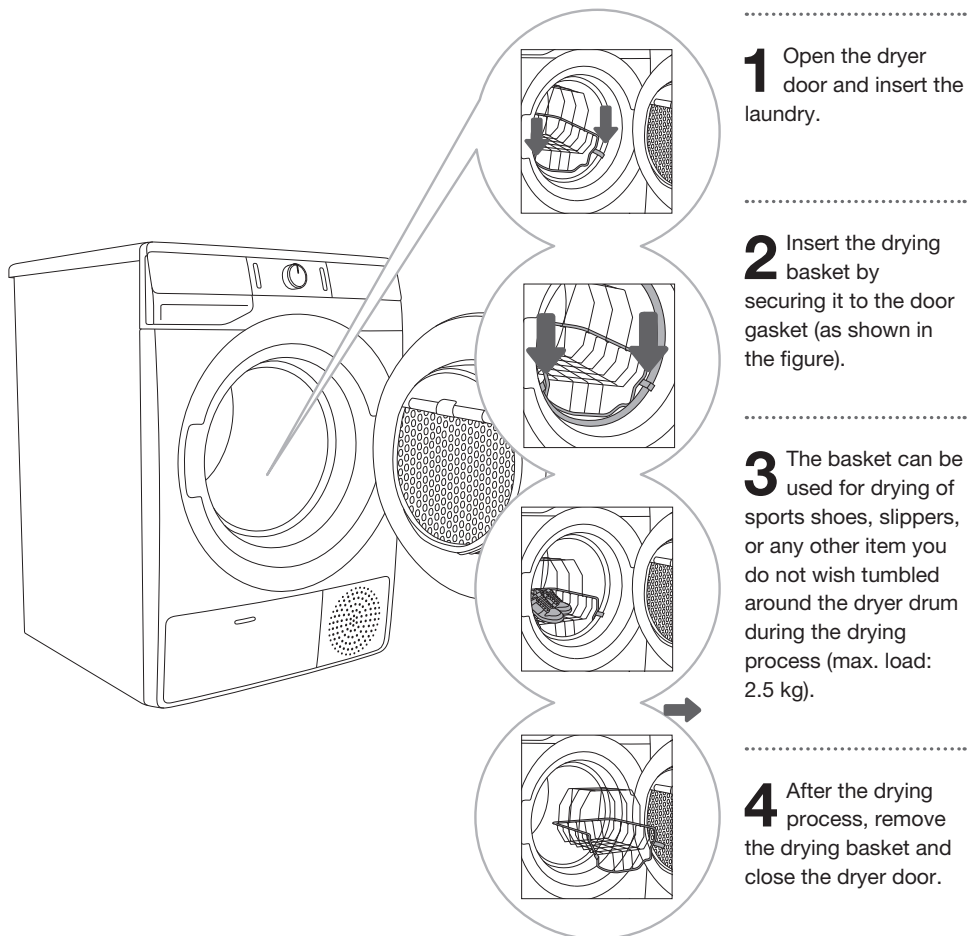

Only dry clean sports shoes or slippers that have been wrung just enough to prevent water from dripping from them.

As the drum rotates, the laundry basket will be still. Therefore, make sure the items you are drying in the basket are not in contact with the drum, as this could result in damage to the item and the dryer.

SWITCHING ON THE DRYER

Connect the dryer to the power mains by plugging in the power cord.
Press the (1) **ON/OFF** button to switch on the dryer (figure 1).

With some models, the dryer drum is lit as well (figure 2).
(The light in the dryer drum is not suitable for any other use.)

⚠ The light in the dryer drum may only be replaced by the manufacturer, a service technician or an authorized person.

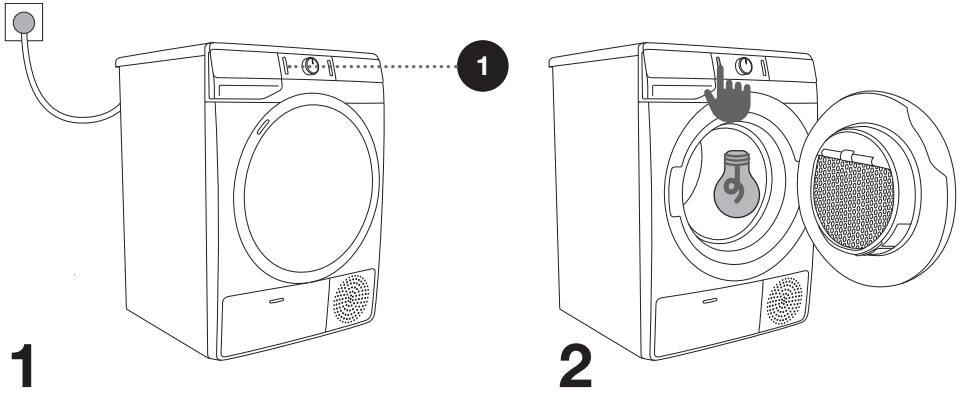

LOADING THE DRYER

Open the dryer door by pulling the left side of the door towards you (figure 1).
Insert the laundry into the drum (after making sure the drum is empty) (figure 2).
Close the dryer door (figure 3).

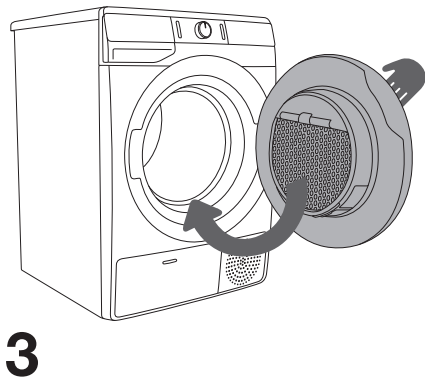
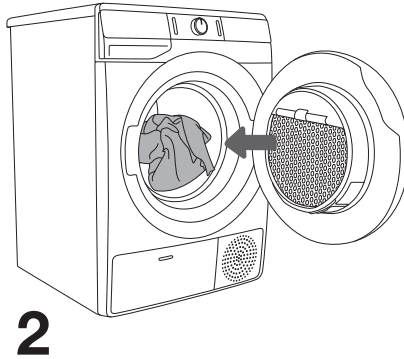
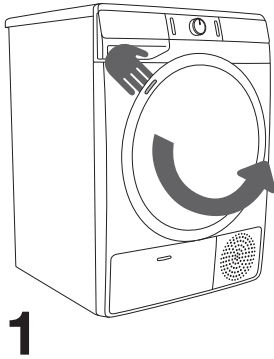

⚠ Do not insert laundry into the dryer if it has not been wrung or spun (recommended minimum spinning cycle: 800 rpm).

Do not overload the drum! See PROGRAMME TABLE and observe your nominal load as indicated on the rating plate.

If the dryer drum is overloaded, the laundry will be more wrinkled and perhaps unevenly dried.

⚠ When drying larger items (bedding, towels, tablecloths etc.), loosen them and then insert them into the dryer drum.

STEP 3: CHOOSING THE DRYING PROGRAMME

Choose the **programme** by rotating the programme selector knob (2) to the left or to the right (depending on the type of laundry and the desired level of dryness). See PROGRAMME TABLE.





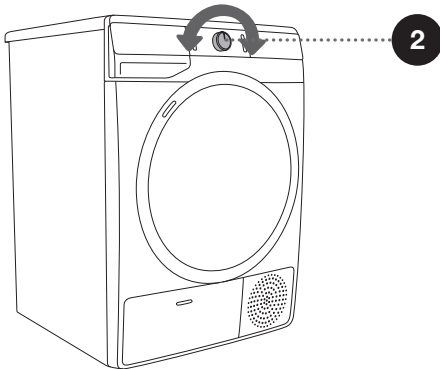





30'	time	bedding	cotton storage	
60'			standard	
90'			iron	
	shirts		mix storage	
	sports		iron	
	baby		wool	
	down wear	air refresh	sensitive	

2



The programme selector knob (2) will not rotate automatically during operation.

PROGRAMME TABLE

Programme Dryness levels	Max. load	Programme description
Cotton		
 Storage (Cupboard dry)	7 kg/ 8 kg	Use this programme for thicker non-sensitive cotton laundry. After drying, it will be dry and ready to be stored in the cupboard.
 Standard* □	7 kg/ 8 kg	Use this programme for thicker non-sensitive cotton laundry of approximately the same thickness. After drying, it will be dry.
 Iron (Moist for ironing)	7 kg/ 8 kg	Use this programme for non-sensitive cotton laundry. After drying, it will be ready for ironing.
Mix (Mixed laundry/Synthetics)		
 Storage (Cupboard dry)	3,5 kg	Use this programme for sensitive laundry made of a mixture of synthetic and cotton fibres. After the drying cycle, the laundry will be dry.
 Iron (Moist for ironing)	3,5 kg	Use this programme for sensitive laundry made of a mixture of synthetic and cotton fibres. After drying, the laundry will be slightly moist.
 Wool	2 kg	This short programme is intended for softening or fluffing of clothes made of wool and silk, which have to be dried thoroughly according to manufacturer s instructions.
 Sensitive	1 kg	Use this programme to dry highly delicate laundry made of synthetic fibres, which may be slightly moist after the drying process. We recommend using a special-purpose laundry bag.
Air refresh	2 kg	In this programme, the heater is switched off. The programme is suitable for refreshing your laundry.
 Down wear	1,5 kg	Use this programme to dry textiles stuffed or padded with down (pillows, duvets, jackets etc.). Dry large items separately and use the EXTRA DRY function or the Time Programme if necessary.
 Baby (Baby clothes)	4 kg	Use this programme to dry baby clothes. Clothes dried with this programme are usually normally dry.
 Sports (Sportswear)	3 kg	Use this programme for clothing with a membrane, for sportswear made of mixed materials, and breathable fabrics.
 Shirts	2 kg	Use this programme to dry shirts and blouses. Adjusted drum rotation prevents the laundry from creasing.

Programme Dryness levels		Max. load	Programme description
	Time (Timed drying program) 90' 60' 30'	4 kg	Use this programme for non-sensitive laundry that is still slightly moist and has to be thoroughly dried. In the time programme, remaining moisture is not detected automatically. If the laundry is still damp after the programme is complete, repeat the programme; if it is too dry and therefore creased and rough to touch, the drying time you selected was too long.
	Bedding	5 kg	Use this programme for larger items. When the programme is complete, they will be dry. Adjusted drum rotation prevents the laundry from tangling.

* Testing programme according to EN 61121

If your laundry is not dried to the desired dryness level, use extra functions or use a more suitable programme.

STEP 4: SELECTING EXTRA FUNCTIONS

☀️ Activate/deactivate the function by pressing the desired position (before pressing the (3) START/PAUSE button).

Adjust the settings by pressing the relevant function button (before pressing the (3) START/PAUSE button).

Functions that can be changed or adjusted with the selected drying programme are partly lit (dimmed).

Certain settings cannot be selected with some programmes. Such settings will not be lit, and the button will flash when pressed (see FUNCTION TABLE).

Description of lighting of functions for the selected drying programme:

- **Lit** (Basic/preset setting);
- **Dimmed** (Functions that can be adjusted) and
- **Unlit** (Functions that cannot be selected).

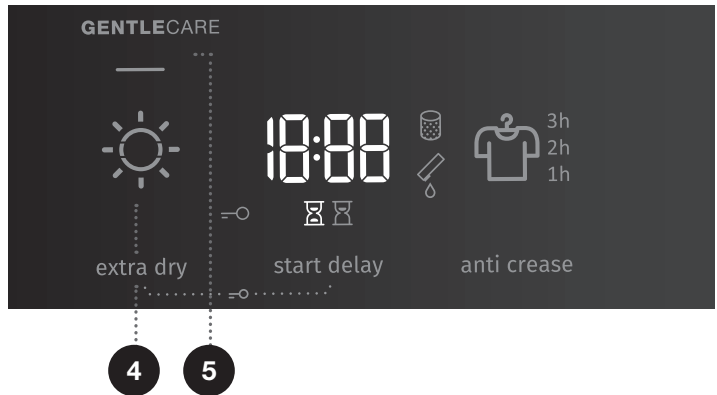

4

EXTRA DRY ☀️

Press on the **EXTRA DRY** position to adjust the dryness level – the dryer the laundry, the longer the drying cycle. This setting can be adjusted before the start of the drying process. After the drying programme, this setting is not stored.

5

GENTLECARE (LOWER TEMPERATURE)

For delicate laundry. Lower temperature depends on the programme for which the function was selected. This setting can be adjusted before the start of the drying process. After the drying programme, this setting is not stored.

7

START DELAY

Desired time when the drying programme should start can be set in advance, which allows more flexibility.

Press the position (7) **START DELAY** (to choose from 0 to 6 in 30-minute steps, and from 6 to 24 hours in 1-hour steps (7a) of start delay; when you press the (3) **START/PAUSE** button, the selected time is displayed. When the set delay time expires, the selected drying programme will start automatically.

To deactivate the start delay, press the position (7) **START DELAY** and hold it for 3 seconds.

In case of a power supply failure before the delay time has elapsed, press the **START/PAUSE** (3) button to resume the countdown.

The symbol ☒ (7b) is lit when the **DRYING TIME** is in progress/counting down.

The symbol ☒ (7c) is lit when the **START DELAY** function (7) is selected.

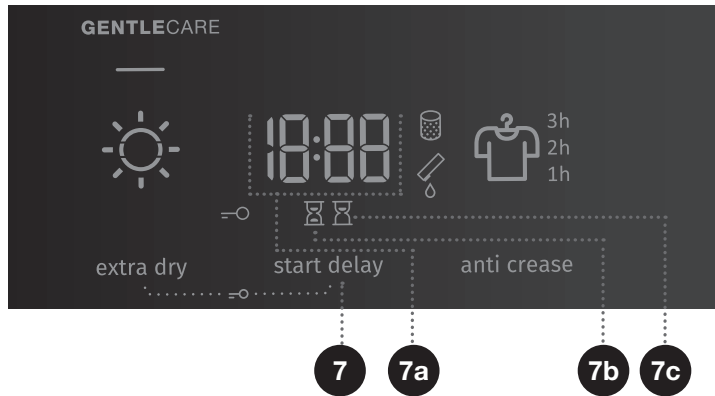

10

ANTI CREASE

If you do not intend or cannot remove the laundry from the dryer immediately after the completion of the drying programme, we recommend using the (10) **ANTI CREASE** function which has to be selected before the start of the drying process.

Press on the position (10) **ANTI CREASE** to choose between 1h, 2h, and 3h (10a) or deactivating this function. When you open the dryer door after the completion of the drying programme, the function is automatically deactivated.

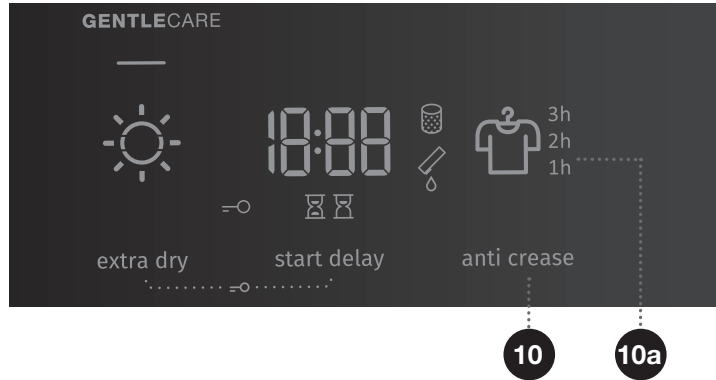





CHILD LOCK

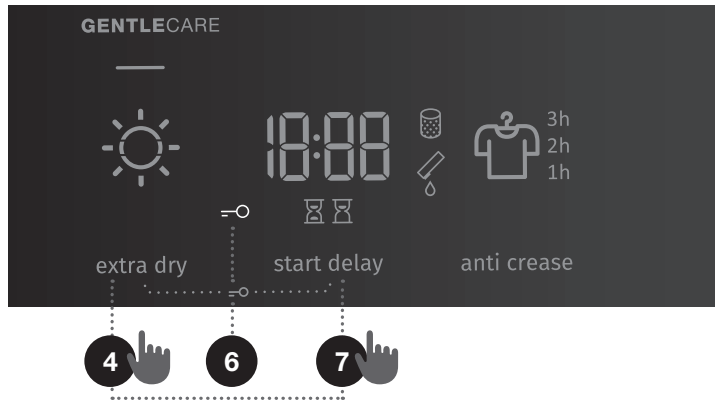









To activate or deactivate the child lock, press the positions (4) **EXTRA DRY** and (7) **START DELAY** simultaneously and hold them for at least 3 seconds until the symbol  (6) lights up or goes off, respectively. If the child lock is activated, programme or additional functions cannot be changed. The child lock remains active after the dryer is switched off. Therefore, it has to be deactivated before a new programme can be selected. It can also be switched off during the drying process.



 Some functions are not available and cannot be selected with certain programmes; an acoustic signal and a flashing light will indicate such cases (see EXTRA FUNCTION TABLE).

 After disconnecting the dryer from the power mains, all settings will be reset to their default factory values, except for the acoustic signal loudness, anti-crease, and child lock setting.

EXTRA FUNCTION TABLE

Programi	GENTLE CARE (LOWER TEMPERATURE)	EXTRA DRY	START DELAY	ANTI CREASE
Cotton				
 Storage (Cupboard dry)	•	•	•	•
 Standard	•	•	•	•
 Iron (Moist for ironing)	•	•	•	•
Mix (Mixed laundry/Synthetics)				
 Storage (Cupboard dry)	•	•	•	•
 Iron (Moist for ironing)	•	•	•	•
 Wool				
 Sensitive		•	•	•
Air refresh				
 Down wear	•	•	•	•
 Baby (Baby clothes)	•	•	•	•
 Sports (Sportswear)		•	•	•
 Shirts	•	•	•	•
Time (Timed drying program)				
90'	•			•
60'	•			•
30'	•			•
Bedding	•	•	•	•

- Extra functions can be used

If your laundry is not dried to the desired dryness level, use extra functions or use a more suitable programme.

STEP 5: STARTING THE DRYING PROGRAMME

Press the button (3) **START/PAUSE**.

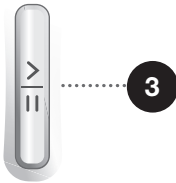

STEP 6: END OF THE DRYING PROGRAMME

At the end of the drying programme, »End« will appear on the display unit **End**, the two red indicator lights will light up, and the (3) **START/PAUSE** button light and **ANTI CREASE** (10a) time indicator, if activated or selected, will flash.

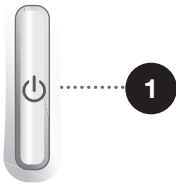

1. Open the dryer door.
2. Clean the filter (see section »CLEANING« ...).
3. Take the laundry from the drum.
4. Close the door!
5. Switch off the dryer (press the (1) **ON/OFF** button).
6. Empty the condensate tank.
7. Unplug the power cord from the outlet.

💡 After the end of the drying programme, immediately remove the laundry from the dryer to prevent it from creasing again.

INTERRUPTIONS AND CHANGING THE PROGRAMME

INTERRUPTIONS

Interrupting the programme process

Press the (3) START/PAUSE button to pause/resume a programme.

To stop and cancel the drying programme, press the (3) START/PAUSE button and hold it for 3 seconds. The selected programme will stop, and the dryer will start to cool down. Cooling down time depends on the selected programme. After this process, the drying programme can be selected again.

Open door

If the dryer door is opened during the drying process, the drying cycle will be interrupted. When the door is closed and the (3) START/PAUSE button is pressed, the drying will resume from the point at which it was interrupted.

 **The dryer door will heat up during the drying process. Make sure you do not burn yourself when opening the dryer door.**

Full condensate tank

When the condensate tank is full, the drying programme will pause (symbol  (9) will be lit up). Empty the condensate tank (see chapter »CLEANING AND MAINTENANCE/Emptying the condensate tank«).

Press the (3) START/PAUSE button to resume the drying programme from the point at which it was interrupted.

Power supply failure

When power supply is resumed, the signal light on the (3) START/PAUSE button will flash.

To resume the drying process, press the (3) START/PAUSE button.

CHANGING THE PROGRAM/FUNCTIONS

Switch off the dryer by pressing the button (1) ON/OFF; then, switch it on again by pressing the button (1) ON/OFF and rotate the (2) programme selector knob to the desired programme, or choose extra functions.

Select another program/function and press the (3) START/PAUSE button again.

ADDING LAUNDRY AFTER THE START OF THE PROGRAM

Open the dryer door and press the (3) **START/PAUSE** button. Insert the laundry and press the button (3) **START/PAUSE**.

 **When loading the laundry, make sure you do not burn yourself when you open the dryer door.**

Drying time may be extended.

SAVING PERSONAL SETTINGS

Initial settings may be changed.

When the programme and additional functions are selected, you may store such combination by pressing the (3) **START/PAUSE** button and holding it for five seconds. An indicator light on the (3) **START/PAUSE** button and an acoustic signal will confirm your selection. »**S C**« (settings changed) will be displayed briefly on the display.

Press the (3) **START/PAUSE** button to start the drying process.

The changed combination will appear every time you switch on the dryer.

Follow the same procedure to change a previously saved combination.

PERSONAL SETTINGS MENU

Switch on the dryer by pressing the (1) **ON/OFF** button. To open the personal settings menu, simultaneously press the positions (7) **START DELAY** and (10) **ANTI CREASE** and hold them for 3 seconds. The symbols (7c) **START DELAY**, (7b) **DRYING TIME**, (8) **FILTER**, and (9) **CONDENSATE TANK** will be lit on the display unit. Number 1 will appear on the LED display, indicating the settings function. Rotate the programme selector knob (2) to the left or to the right to choose the function to change. Number 1 indicates sound settings and number 2 indicates resetting of Personal programme settings to factory defaults. If the desired settings are not selected in 20 seconds, the programme will automatically return to main menu. Press the (7) **START DELAY** position to confirm the desired functions and their settings; press the (4) **EXTRA DRY** position to go back one step. Acoustic signal volume can be set at four levels (0 means the sound is off; 1 means that the button sound is activated; 2 means low volume, and 3 means high volume). Choose the volume level by rotating the programme selector knob (2) to the left or to the right. The lowest setting means that the acoustic signal is switched off.

MAINTENANCE & CLEANING

⚠ Before cleaning, make sure to switch off the dryer and disconnect it from the power mains (unplug the power cord from the outlet).

The dryer is fitted with a **filtering system** consisting of one filter.

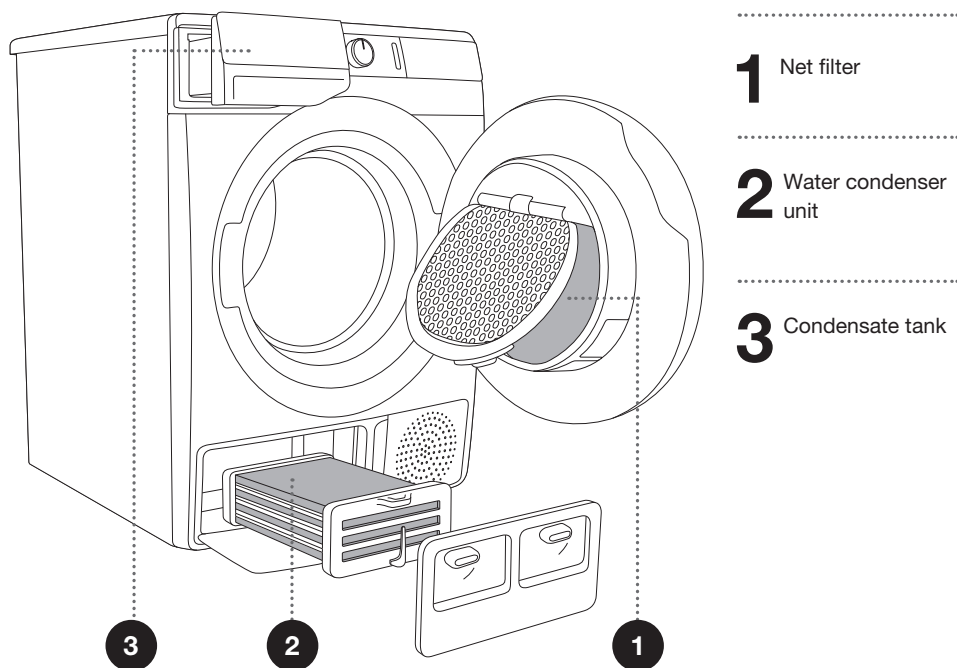

⚠ The dryer may never be operated without the filter in place, or with damaged filter, as excessive amount of accumulated fibres from the fabric could cause malfunction or failure of the dryer.

CLEANING THE NET FILTER IN THE DOOR

☼ Clean the net filter after each drying cycle.

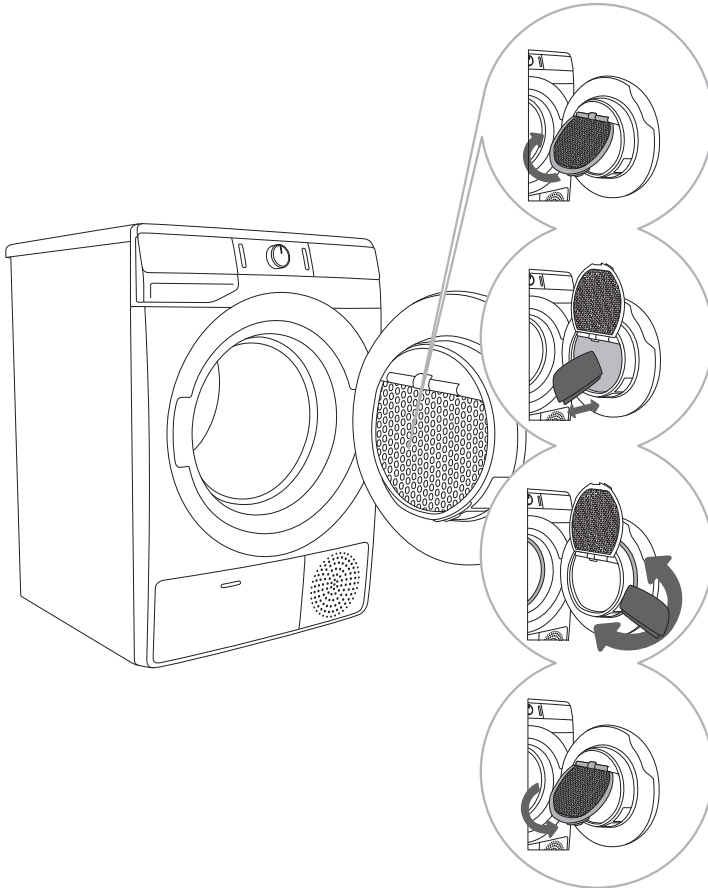

1 Lift the filter cover.

2 Gently scrape the filter to remove the lint, i.e. the lining of fibres and threads, with your hand or with a cloth.

3 If necessary, clean the filter housing and door gasket as well.

4 Close the filter cover.

☼ Make sure you do not pinch your fingers with the filter cover.

CLEANING THE CONDENSER UNIT

⚠ During cleaning, some water may be spilled. It is therefore recommended to place an absorbent cloth on the floor.

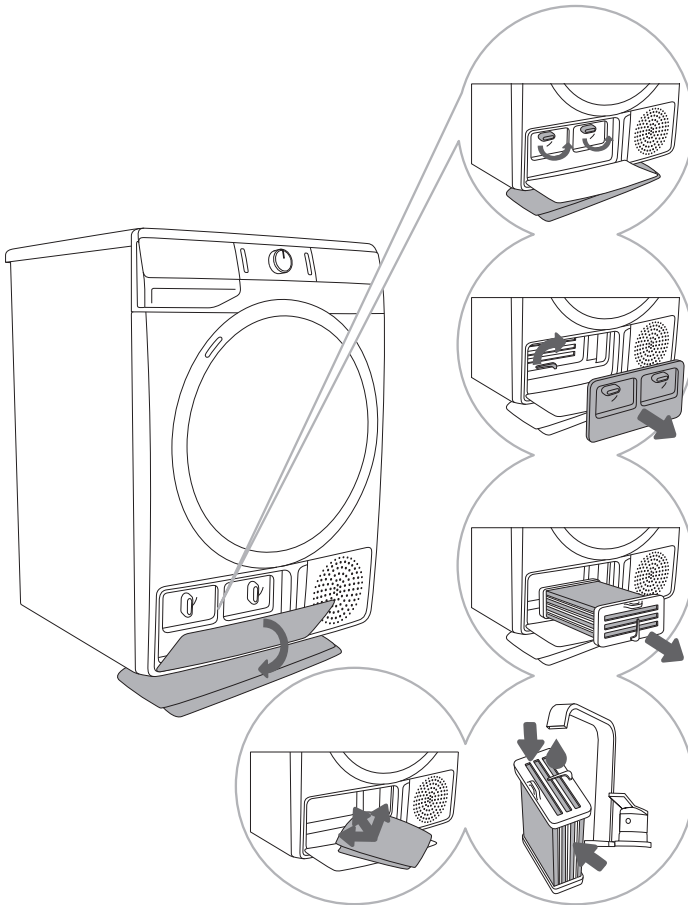

.....
1 Open the outer cover. Hold the levers on the inside cover and rotate them upwards. Remove the inside cover.
.....

2 Remove the inside cover. Rotate the condenser unit lever up.
.....

3 Use the handle to pull out the condenser unit.
.....

4,5 Rinse the inside of the condenser unit with running water on both sides; drain it thoroughly and replace it.

Use a soft damp cloth to clean the space behind the condenser unit (reach deep into the opening as far as the back wall with your hand); then, clean all gaskets and sealing surfaces on the condenser unit housing and door.

⚠ Do not poke into the openings between the condenser unit ribs as this may damage the condenser unit.

⚠ Do not wash the condenser unit in a dishwasher.

EMPTYING THE CONDENSATE TANK

☼ Empty the condensate tank after each drying cycle.

If the condensate tank is full, the drying programme will be paused automatically.

Symbol ☼ (9) will light up on the display unit, indicating that the condensate tank should be emptied.

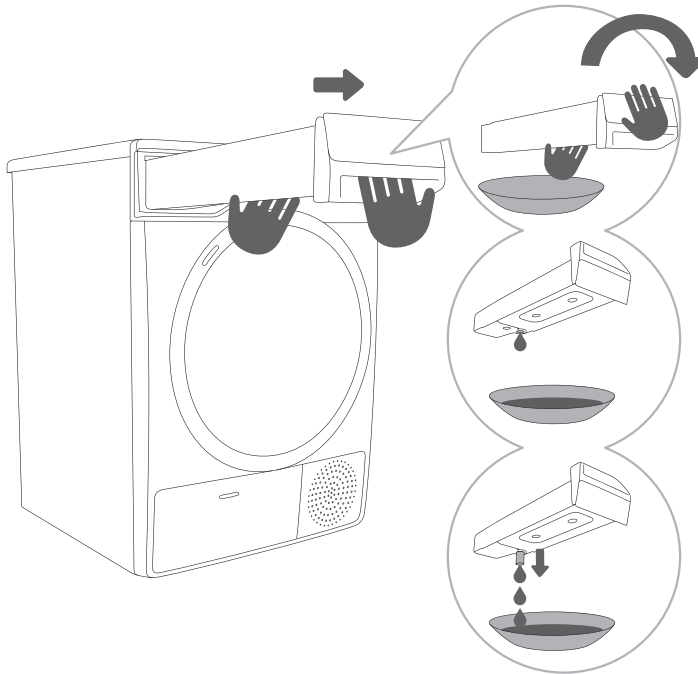

1 Pull out the condensate tank from the dryer (using both hands as shown in the figure), then turn it upside down over a washbasin, sink, or any suitable vessel.

2,3 Empty the condensate tank. When emptying the tank, pull out the spout that simplifies pouring the water from the tank, and be careful to avoid burns as the water may be hot. Replace the condensate tank.

☼ Water from the condensate tank is not potable. If thoroughly filtered, it can be used for ironing.

⚠ Never add chemicals or fragrances into the condensate tank.

It is not necessary to empty the condensate tank if the drain hose is connected directly to a drain (see chapter »INSTALLATION AND CONNECTION/Draining the condensate«).

CLEANING THE DRYER

⚠ Always disconnect the dryer from the power mains before cleaning.

Clean the dryer exterior using a soft damp cotton cloth.

⚠ Do not use any solvents or cleaning agents that could damage the dryer (please observe the recommendations and warnings provided by the manufacturers of the cleaning agents).

Wipe all parts of the dryer with a soft cloth until dry.

⚡ Do not clean the dryer with a jet of water!

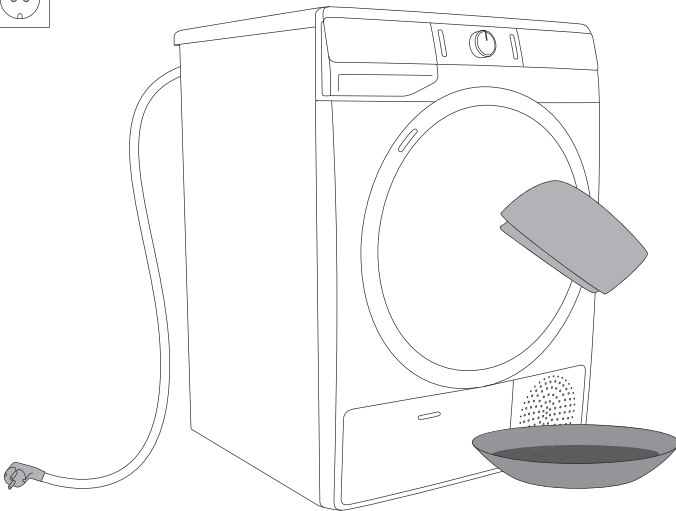

TROUBLESHOOTING

WHAT TO DO ...?

Disturbances from the environment (e.g. the power grid) may result in various error reports (see TROUBLESHOOTING TABLE). In such case:

- Switch off the dryer and wait at least one minute.
- Switch on the dryer and repeat the drying programme.
- Most errors during operation can be resolved by the user (see TROUBLESHOOTING TABLE).
- If the error persists, call an authorized service unit.
- Repairs may only be carried out by an adequately trained person.
- Repair or any warranty claim resulting from incorrect connection or use of the dryer shall not be covered by the warranty. In such cases, the costs of repair shall be charged to the user.





 The warranty does not cover the errors or failures resulting from disturbances from the environment (lightning strike, power grid failures, natural disasters etc.).





TROUBLESHOOTING TABLE

Problem/error	Cause	What to do?
The machine will not start.	• The main switch is not switched on.	• Check whether the main switch is on.
	• There is no voltage in the power outlet.	• Check the fuse. • Check if the power cord plug is correctly inserted into the power outlet.
There is voltage in the outlet, but the drum does not spin and the appliance does not work.	• Open the door.	• Check if the door is closed properly.
	• The condensate tank is full.	• Empty the condensate tank (see chapter »CLEANING AND MAINTENANCE/Emptying the condensate tank«).
	• Perhaps the START DELAY function was set. • Programme was not started in accordance with the instructions.	• To cancel the start delay, press the position (7) START DELAY and hold for 3 seconds. • Re-read the instructions for use again.
The appliance stops heating completely during a programme.	• The net filter may be clogged. As a result, the temperature in the dryer rises, which in turn causes overheating, and therefore heating is switched off.	• Clean the net filter (see chapter »CLEANING AND MAINTENANCE/Cleaning the net filter in the door«). • Wait for the appliance to cool down, and try running it again. If the dryer still fails to start, call a service technician.
A slight hitting noise appears.	• If the dryer is out of use for a long period of time, the support elements are under stress at the same point.	• The noise will subside without any intervention.
The door opens during drying.	• Excessive load on the door (too much laundry in the drum).	• Reduce the amount of laundry.
Unevenly dried laundry.	• Laundry of varying types and thickness, or excessive amount of laundry.	• Make sure you have sorted the laundry by type and thickness, whether you have added a suitable amount of laundry to the drum, and whether you have selected a suitable programme (see PROGRAMME TABLE).



Problem/error	Cause	What to do?
Laundry not dried or drying takes too long	<ul style="list-style-type: none"> • Filter is not cleaned. 	<ul style="list-style-type: none"> • Clean the filter (see chapter »CLEANING AND MAINTENANCE/ Cleaning the net filter in the door«).
	<ul style="list-style-type: none"> • Dryer is placed in a closed room; room that is too cold; or room that is too small and the air overheats as a result. 	<ul style="list-style-type: none"> • Make sure there is adequate supply of fresh air to the dryer; for example, open the door and/or window. • Check if the temperature in the room where the dryer is installed is too high or too low.
	<ul style="list-style-type: none"> • Laundry was not sufficiently wrung or spun. 	<ul style="list-style-type: none"> • If the laundry is still wet after the drying cycle, repeat the drying and select an appropriate drying programme (after cleaning the filter).
	<ul style="list-style-type: none"> • Amount of laundry dried in the appliance is too large or insufficient. 	<ul style="list-style-type: none"> • Use a suitable programme or extra functions.
	<ul style="list-style-type: none"> • Laundry (such as bedding) gets tangled into large balls. 	<ul style="list-style-type: none"> • Close the buttons or zippers on the laundry before drying. Select a suitable programme (e.g. the Bedding program). • After the drying process, loosen the laundry and select an additional drying programme (e.g. Time (Timed drying program)).
Drum lighting error	<ul style="list-style-type: none"> • There is no lighting when the dryer door is opened. 	<ul style="list-style-type: none"> • Disconnect the dryer from the power mains and call an authorized service unit.

Errors indicated on the display unit may include the following:

Problem/error	Indication on the display unit and description of error	What to do?
E0	Control unit failure 	Call service centre.
E1	Temperature sensor failure 	Call service centre.
E2	Communication error 	Call service centre.
E3	Pump error 	Call service centre.

Problem/error	Indication on the display unit and description of error	What to do?
E4	System overheating 	Clean the filter. See chapter »CLEANING AND MAINTENANCE/Cleaning the net filter in the door« or call a service technician.
E6, E7, E8	Control unit failure   	Disconnect the tumble dryer from the power supply. Call service centre.

Warnings indicated on the display unit may include the following:

Warning	Indication on the display unit and description of warning	What to do?
	Condensate tank warning 	Empty the condensate tank before resuming the programme (see chapter »CLEANING AND MAINTENANCE/Emptying the condensate tank«).
»PF«	Power supply failure warning 	Drying interrupted due to power supply failure. Press the (3) START/PAUSE button to restart or resume the drying programme.

Write down the error code (e.g. E0, E1), switch off the dryer, and call the nearest authorized service (call centre).

Sounds

 In the initial drying stage, the heat pump causes noise; this, however, does not affect the tumble dryer operation.

Pumping or liquid flowing sound: the pump is pumping the condensate into the condensate tank.

Rumbling or rattling noise: during drying when the laundry also includes hard parts (such as buttons, zippers etc.)

SERVICING

Before calling a service technician

When you contact a service centre, please state your dryer's type (1), code/ID (2), model number (3), and serial number (4).

Type, code/ID, model, and serial number are indicated on the rating (type) plate located on the front side of the dryer door opening.

⚠ In case of a failure, only use approved spare parts by authorized manufacturers.

⚠ Repair or any warranty claim resulting from incorrect connection or use of the dryer shall not be covered by the warranty. In such cases, the costs of repair shall be charged to the user.

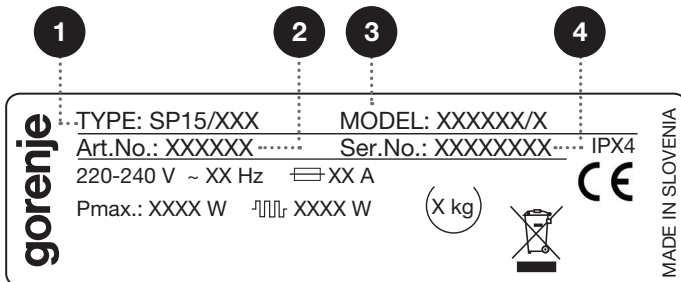
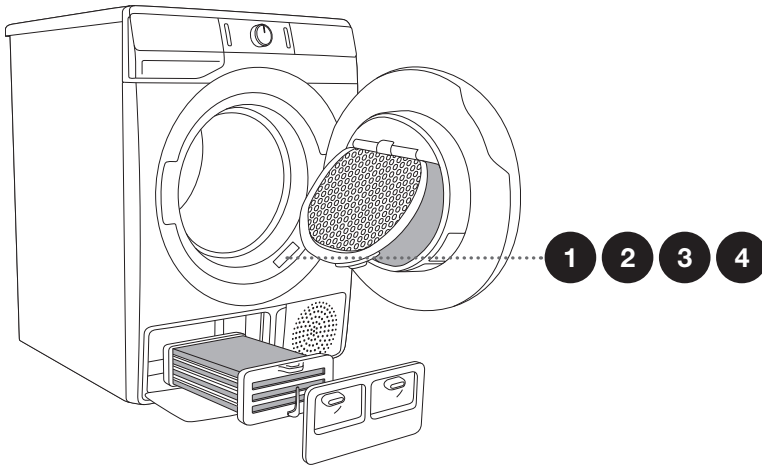

Additional equipment and accessories for maintenance can be viewed on our website at: www.gorenje.com.

TIPS FOR DRYING AND ECONOMIC USE YOUR DRYER

The most economical way of drying is to dry the recommended amount of laundry in each batch (see PROGRAMME TABLE).

Drying laundry made of particularly delicate fabrics that may be deformed is not recommended.

Use of conditioner in the washing cycle is not necessary as the laundry is soft and smooth after drying in the dryer. Drying time will be shorter and power consumption will be lower if the garments are thoroughly wrung or spun before drying. By selecting the appropriate drying programme, you will avoid over-drying your laundry and problems with ironing or shrinkage of fabric.

Regular cleaning of the filters will lead to optimum drying time and minimum power consumption.

When drying smaller amounts of laundry or individual garments, the sensor may not perceive the actual level of moisture in the laundry. In such cases, it is recommended to dry smaller items or amounts with programmes for dryer laundry or with the timed programme.

DISPOSAL

Packaging is made of environmentally friendly materials that can be recycled, disposed of, or destroyed without any hazard to the environment. To this end, packaging materials are labelled appropriately.



The symbol on the product or its packaging indicates that the product should not be treated as normal household waste. Take the product to an authorized collection centre for waste electric and electronic equipment processing.

When **disposing** of the dryer at the end of its useful life, remove all power cords, and destroy the door latch and switch to prevent the door from locking or latching (child safety).

Correct **disposal** of the product will help prevent any negative effects on the environment and health of people, which could occur in case of incorrect product removal. For detailed information on removal and processing of the product, please contact the relevant municipal body in charge of waste management, your waste disposal service, or the store where you bought the product.

TYPICAL CONSUMPTION TABLE

The table lists the values for drying time and power consumption for drying of a test batch of laundry with various spinning rpm in the washing machine.

SPK B Programme	Load	Spinning [rpm]	Electric energy consumption [kWh]		Drying time [min]	
			7 kg	8 kg	7 kg	8 kg
Cotton Standard	Total	1000	4,25	4,75	125	145
	Partial	1400	2,45	2,60	85	94
	Low	1000	2,30	2,54	79	91
	Low	1400	2,15	2,23	75	80
Cotton moist for ironing	Total	1000	3,70	3,75	90	115
	Partial	1400	2,25	2,45	82	84
	Low	1400	2,05	2,15	72	75
Mixed laundry/Synthetics moist for ironing	Partial	1000	1,50	1,50	55	55

measured by standard EN 61121

Standard programmes for cotton laundry in compliance with the currently effective regulation EU 392/2012

Programme	Amount of laundry Max./half load [kg]	Programme duration [min]	Electric energy consumption [kWh]
Cotton Standard ☐	7/3,5	125/79	4,25/2,30
Cotton Standard ☐	8/4	145/91	4,75/2,54

The Cotton Standard programme ☐, is intended for drying of normally wet cotton laundry. It is the most efficient programme for drying cotton laundry in terms of power consumption.

Due to deviations in terms of type and amount of laundry, power supply oscillation, and environment temperature and humidity, the values measured at the end user may differ from the one stated in the table.

LOW STANDBY MODE

If you do not run a programme or do anything else after switching on the dryer, the dryer will switch off automatically after 5 minutes to save energy. Indicator light on the (3) START/PAUSE button will flash.

The display will be reactivated if you rotate the programme selector knob or press the (1) ON/OFF button or open the dryer door. If you do not do anything for 5 minutes after the end of the programme, the display unit will be switched off as well. Indicator light on the (3) START/PAUSE button will flash.

P_o = weighted power when off [W]	< 0,5 W
P_I = weighted power when in standby [W]	< 0,5 W
T_I = standby time [min]	5,00

⚡ Low mains voltage and different drying loads may affect the drying time; the remaining time displayed is adjusted accordingly during the drying process.

We reserve the right to any changes and errors in the instructions for use.



ENERG
енергия · ενεργεια



XXXXXX



ENERGIA · ЕНЕРГИЯ · ΕΝΕΡΓΕΙΑ
ENERGIJA · ENERGY · ENERGIE
ENERGI

XXX
kWh/annum



XXX
min/cycle*

X
kg

XX
dB

XXXXXXXX

*цикъл · cyklus · portion · zklus
πρόγραμμα · ciclo · tsükkel
ohjelma · ciklus · ciklas · cikls
čiklu · cyclus · cykl · ciclu
program · torkomgång

392/2012

PRODUCT FICHE according to EU-Regulation No. 392/2012

Legend

A	Modelna oznaka	XXXXXX
B	Condenser tumble dryer Vented tumble dryer	YES=YES; NO=NO YES=YES; NO=NO
C	Automatic tumble dryer	YES=YES; NO=NO
D	»EU Ecolabel award« Regulation (EC) No 66/2010	YES=YES; NO=NO
E	Energy consumption of the standard cotton programme at full load (E_{dry}) [kWh]	X,XX
F	Energy consumption of the standard cotton programme at partial load ($E_{dry/2}$) [kWh]	X,XX
G	Power consumption of the off-mode (P_0) [W]	X,XX
H	Power consumption of the left-on mode (P_l) [W]	X,XX
I	The duration of the left-on mode [min]	XX
J	Standard cotton programme, used at full and partial load is the standard drying programme to which the information in the label and the fiche relates. Cotton Standard \square program is intended for drying of normally wet cotton laundry. In terms of total energy consumption, it is the most efficient program for drying cotton laundry.	
K	Weighted programme time (T_i) of the standard cotton programme at full and partial load [min]	XX
L	Programme time of the standard cotton programme at full load (T_{dry}) and partial load ($T_{dry/2}$) [min]	XX/XX
M	Average condensation efficiency (C_{dry}) / ($C_{dry/2}$)	XX/XX
N	Weighted condensation efficiency (C_i)	XX
O	Built-in appliance	YES=YES; NO=NO

Based on 160 standard drying cycles with the Cotton Standard program \square with full and half load, in compliance with EN61121.

Actual power consumption will depend on the way the appliance is used.

On a scale from D (the least efficient) to A+++ (the most efficient).

SP15 L0 ESSENTIAL SPK



624905

en (02-19)