



SOUNDBAR 500

Please read and keep all safety and use instructions.

Important Safety Instructions

1. Read these instructions.
2. Keep these instructions.
3. Heed all warnings.
4. Follow all instructions.
5. Do not use this apparatus near water.
6. Clean only with a dry cloth.
7. Do not block any ventilation openings. Install in accordance with the manufacturer's instructions.
8. Do not install near any heat sources such as radiators, heat registers, stoves, or other apparatus (including amplifiers) that produce heat.
9. Protect the power cord from being walked on or pinched particularly at plugs, convenience receptacles, and the point where they exit from the apparatus.
10. Only use attachments/accessories specified by the manufacturer.
11.  Use only with the cart, stand, tripod, bracket, or table specified by the manufacturer, or sold with the apparatus. When a cart is used, use caution when moving the cart/apparatus combination to avoid injury from tip-over.
12. Unplug this apparatus during lightning storms or when unused for long periods of time.
13. Refer all servicing to qualified personnel. Servicing is required when the apparatus has been damaged in any way, such as power-supply cord or plug is damaged, liquid has been spilled or objects have fallen into the apparatus, the apparatus has been exposed to rain or moisture, does not operate normally, or has been dropped.

WARNINGS/CAUTIONS



This symbol on the product means there is uninsulated, dangerous voltage within the product enclosure that may present a risk of electrical shock.



This symbol on the product means there are important operating and maintenance instructions in this guide.



Contains small parts which may be a choking hazard. Not suitable for children under age 3.



This product contains magnetic material. Consult your physician on whether this might affect your implantable medical device.

- To reduce the risk of fire or electrical shock, do NOT expose this product to rain, liquids or moisture.
- Do NOT expose this product to dripping or splashing, and do not place objects filled with liquids, such as vases, on or near the product.
- Keep the product away from fire and heat sources. Do NOT place naked flame sources, such as lighted candles, on or near the product.
- Do NOT make unauthorized alterations to this product.
- Do NOT use in vehicles or boats.
- Use this product only with the power supply provided.
- Where the mains plug or an appliance coupler is used as the disconnect device, the disconnect device shall remain readily operable.



仅适用于 2000m 以下地区安全使用

Use at altitude less than 2000 meters only.

- The battery provided with this product may present a risk of fire or chemical burn if mishandled.
- If the battery leaks, do not allow the liquid to come in contact with the skin or eyes. If contact is made, seek medical advice.
- Do not expose products containing batteries to excessive heat (e.g. from storage in direct sunlight, fire or the like).
- Only use the following hardware to mount this product: Bose Soundbar Wall Bracket.

NOTE: This equipment has been tested and found to comply with the limits for a Class B digital device, pursuant to Part 15 of the FCC Rules. These limits are designed to provide reasonable protection against harmful interference in a residential installation. This equipment generates, uses, and can radiate radio frequency energy and, if not installed and used in accordance with the instructions, may cause harmful interference to radio communications. However, there is no guarantee that interference will not occur in a particular installation. If this equipment does cause harmful interference to radio or television reception, which can be determined by turning the equipment off and on, the user is encouraged to try to correct the interference by one or more of the following measures:

- Reorient or relocate the receiving antenna.
- Increase the separation between the equipment and receiver.
- Connect the equipment into an outlet on a circuit different from that to which the receiver is connected.
- Consult the dealer or an experienced radio/TV technician for help.

Changes or modifications not expressly approved by Bose Corporation could void the user's authority to operate this equipment.

This device complies with part 15 of the FCC Rules and with Industry Canada license-exempt RSS standard(s). Operation is subject to the following two conditions: (1) This device may not cause harmful interference, and (2) this device must accept any interference received, including interference that may cause undesired operation.

This device complies with FCC and Industry Canada radiation exposure limits set forth for general population. This equipment should be installed and operated with a minimum distance of 20 cm between radiator and your body. This transmitter must not be co-located or operating in conjunction with any other antenna or transmitter.

This device for operation in the band 5150 – 5250 MHz is only for indoor use to reduce the potential for harmful interference to other co-channel mobile satellite systems.

CAN ICES-3 (B)/NMB-3(B)

CE Bose Corporation hereby declares that this product is in compliance with the essential requirements and other relevant provisions of Directive 2014/53/EU and all other applicable EU directive requirements. The complete declaration of conformity can be found at: www.Bose.com/compliance

The product, in accordance with the Ecodesign Requirements for Energy Related Products Directive 2009/125/EC, is in compliance with the following norm(s) or document(s): Regulation (EC) No. 1275/2008, as amended by Regulation (EU) No. 801/2013.

Required Power State Information	Power Modes	
	Standby*	Networked Standby
Power consumption in specified power mode, at 230V/50Hz input	< 0.5 W	all network types ≤ 2.0 W
Time after which equipment is automatically switched into mode	< 2.5 hours	≤ 20 minutes
Power consumption in networked standby if all wired network ports are connected and all wireless network ports are activated, at 230V/50Hz input	N/A	≤ 2.0 W
<p>Network port deactivation/activation procedures. Deactivating all networks will enable standby mode.*</p> <p>* Prior to deactivating networks or entering standby mode, use the microphone on/off button to ensure the microphone is turned on (the red indicator light will be off).</p>	<p>Wi-Fi®: Deactivate by pressing and holding the Bose Music and Skip Forward buttons on the remote simultaneously. Repeat to activate.</p> <p>Bluetooth®: Deactivate by clearing the pairing list by pressing and holding the <i>Bluetooth®</i> button on the remote for 10 seconds. Activate by pairing with a <i>Bluetooth®</i> source.</p> <p>Ethernet: Deactivate by removing the Ethernet cable. Activate by inserting the Ethernet cable.</p>	

For Europe:

Frequency band of operation 2400 to 2483.5 MHz:

- *Bluetooth*/Wi-Fi: Maximum transmit power less than 20 dBm EIRP.
- *Bluetooth* Low Energy: Maximum power spectral density less than 10 dBm/MHz EIRP.

Frequency bands of operation 5150 to 5350 MHz and 5470 to 5725 MHz:

- Wi-Fi: Maximum transmit power less than 20 dBm EIRP.

This device is restricted to indoor use when operating in the 5150 to 5350 MHz frequency range in all EU Member States listed in the table.

									
BE	DK	IE	UK	FR	CY	SK	HU	AT	SE
BG	DE	PT	EL	HR	LV	LT	MT	PL	
CZ	EE	FI	ES	IT	RO	LU	NL	SI	



This symbol means the product must not be discarded as household waste, and should be delivered to an appropriate collection facility for recycling. Proper disposal and recycling helps protect natural resources, human health and the environment. For more information on disposal and recycling of this product, contact your local municipality, disposal service, or the shop where you bought this product.

Management Regulation for Low-power Radio-frequency Devices

Article XII

According to “Management Regulation for Low-power Radio-frequency Devices” without permission granted by the NCC, any company, enterprise, or user is not allowed to change frequency, enhance transmitting power or alter original characteristic as well as performance to an approved low power radio-frequency devices.

Article XIV

The low power radio-frequency devices shall not influence aircraft security and interfere legal communications; If found, the user shall cease operating immediately until no interference is achieved. The said legal communications means radio communications operated in compliance with the Telecommunications Act.

The low power radio-frequency devices must be susceptible with the interference from legal communications or ISM radio wave radiated devices.



Please dispose of used batteries properly, following local regulations. Do not incinerate.

China Restriction of Hazardous Substances Table

Names and Contents of Toxic or Hazardous Substances or Elements						
Part Name	Toxic or Hazardous Substances and Elements					
	Lead (Pb)	Mercury (Hg)	Cadmium (Cd)	Hexavalent (CR(VI))	Polybrominated Biphenyl (PBB)	Polybrominated diphenylether (PBDE)
PCBs	X	0	0	0	0	0
Metal Parts	X	0	0	0	0	0
Plastic Parts	0	0	0	0	0	0
Speakers	X	0	0	0	0	0
Cables	X	0	0	0	0	0
This table is prepared in accordance with the provisions of SJ/T 11364. O: Indicates that this toxic or hazardous substance contained in all of the homogeneous materials for this part is below the limit requirement of GB/T 26572. X: Indicates that this toxic or hazardous substance contained in at least one of the homogeneous materials used for this part is above the limit requirement of GB/T 26572.						

Taiwan Restriction of Hazardous Substances Table

Equipment name: Powered Speaker, Type designation: 424096						
Restricted substances and its chemical symbols						
Unit	Lead (Pb)	Mercury (Hg)	Cadmium (Cd)	Hexavalent chromium (Cr+6)	Polybrominated biphenyls (PBB)	Polybrominated diphenyl ethers (PBDE)
PCBs	-	o	o	o	o	o
Metal Parts	-	o	o	o	o	o
Plastic Parts	o	o	o	o	o	o
Speakers	-	o	o	o	o	o
Cables	-	o	o	o	o	o
Note 1: "o" indicates that the percentage content of the restricted substance does not exceed the percentage of reference value of presence. Note 2: The "-" indicates that the restricted substance corresponds to the exemption.						

Please complete and retain for your records

The serial and model numbers are located on the back of the soundbar.

Serial number: _____

Model number: _____

Please keep your receipt with your owner's guide. Now is a good time to register your Bose product.

You can easily do this by going to global.Bose.com/register

Date of Manufacture: The eighth digit in the serial number indicates the year of manufacture; “9” is 2009 or 2019.

China Importer: Bose Electronics (Shanghai) Company Limited, Part C, Plan 9, No. 353 North Riyang Road, China (Shanghai) Pilot Free Trade Zone

EU Importer: Bose Products B.V., Gorslaan 60, 1441 RG Purmerend, The Netherlands

Taiwan Importer: Bose Taiwan Branch, 9F-A1, No.10, Section 3, Minsheng East Road, Taipei City 104, Taiwan
Phone Number: +886-2-2514 7676

Mexico Importer: Bose de México, S. de R.L. de C.V. , Paseo de las Palmas 405-204, Lomas de Chapultepec, 11000 México, D.F. Phone Number: +5255 (5202) 3545

Input Rating: 24 Vdc --- 1.875A

Amazon, Alexa, Amazon Music, and all related logos are trademarks of Amazon, Inc. or its affiliates.

Apple, the Apple logo, and AirPlay are trademarks of Apple Inc., registered in the U.S. and other countries. App Store is a service mark of Apple Inc.

Use of the Works with Apple badge means that an accessory has been designed to work specifically with the technology identified in the badge and has been certified by the developer to meet Apple performance standards.

The *Bluetooth*[®] word mark and logos are registered trademarks owned by Bluetooth SIG, Inc. and any use of such marks by Bose Corporation is under license.

 **DOLBY AUDIO**[™] Dolby, Dolby Audio and the double-D symbol are trademarks of Dolby Laboratories.

Google, Google Play, and the Google Play logo are trademarks of Google LLC.

 **HDMI**[™] The terms HDMI, HDMI High-Definition Multimedia Interface, and the HDMI logo are trademarks or registered trademarks of HDMI Licensing Administrator, Inc.

This product contains the iHeartRadio service. iHeartRadio is a registered trademark of iHeartMedia, Inc.

This product is protected by certain intellectual property rights of Microsoft. Use or distribution of such technology outside of this product is prohibited without a license from Microsoft.

Pandora is a registered trademark of Pandora Media, Inc. used with permission.

This product incorporates Spotify software which is subject to 3rd party licenses found here:
www.spotify.com/connect/third-party-licenses

Spotify is a registered trademark of Spotify AB.

Designed with UEI Technology[™]. Under License from Universal Electronics, Inc. © UEI 2000-2018



Wi-Fi is a registered trademark of Wi-Fi Alliance[®].

Acoustimass, ADAPTiQ, Bose, Bose Bass Module, Bose Music, Bose Soundbar, Bose Soundbar Universal Remote, Bose Soundbar Wall Bracket, Bose Surround Speakers, and Virtually Invisible are trademarks of Bose Corporation.

Bose Corporation Headquarters: 1-877-230-5639

©2019 Bose Corporation. No part of this work may be reproduced, modified, distributed or otherwise used without prior written permission.

To view the license disclosures that apply to the software packages included as components of your Bose Soundbar 500 product:

1. On the remote, press and hold the *Bluetooth* button  and Skip backward button  for 5 seconds.
2. Connect a USB cable to the SERVICE connector on the back of the soundbar.
3. Connect the other end of the cable to a computer.
4. On the computer, enter <http://203.0.113.1/opensource> in a browser window to display the EULA and license disclosure.

WHAT'S IN THE CARTON

Contents 13

SOUNDBAR PLACEMENT

Recommendations..... 14
 Wall mount the soundbar 15

POWER

Connect the soundbar to power..... 16
 Network standby..... 16

BOSE MUSIC APP SETUP

Download the Bose Music app..... 17

EXISTING BOSE MUSIC APP USERS

Add the soundbar to an existing account..... 18
 Connect to a different Wi-Fi® network..... 18

ADAPTiQ AUDIO CALIBRATION

Run ADAPTiQ audio calibration using the Bose Music app..... 19

SOUNDBAR CONTROLS

Voice assistant controls..... 20
 Remote functions..... 20
 Power..... 21
 Sources 22
 Presets 23
 Media playback and volume..... 24
 Adjust the bass 25
 Program a third-party remote 25

VOICE ASSISTANT

Voice assistant options..... 26

Set up your voice assistant 26

Access Alexa..... 27

Use your voice 27

Use the soundbar controls..... 28

Access your Google Assistant 29

Use your voice 29

Use the soundbar controls..... 30

Play music with your Google Assistant..... 31

Choose a default audio service..... 31

PRESET PERSONALIZATION

Set a preset 32

Play a preset 33

***BLUETOOTH*[®] CONNECTIONS**

Connect a mobile device 34

Disconnect a mobile device..... 35

Reconnect a mobile device..... 35

Connect an additional mobile device 36

Clear the soundbar device list 36

STREAM AUDIO WITH AIRPLAY

Stream audio from the Control Center..... 37

Stream audio from an app 37

SOUNDBAR STATUS

Wi-Fi status 38

Bluetooth status 38

Voice assistant status 39

 Microphone off indicator 39

Media playback and volume 40

Update and error status 40

ADVANCED FEATURES

Update the soundbar 41

Disable/enable Wi-Fi capability 41

Connect accessories (optional)..... 42

CARE AND MAINTENANCE

Install the remote batteries..... 43

Clean the soundbar 44

Replacement parts and accessories..... 44

Limited warranty 44

TROUBLESHOOTING

Try these solutions first 45

Other solutions 45

Reset the soundbar..... 51

APPENDIX: SETUP REFERENCE

Connection options..... 52

Connect the soundbar to your TV 53

 Option 1 (preferred): HDMI eARC or ARC..... 53

 Option 2: Optical (not provided)..... 54

Check for sound 55

CONTENTS

Confirm that the following parts are included:



Bose Soundbar 500

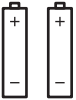

AAA Battery (2)

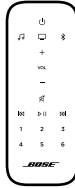

Remote

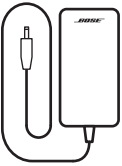

Power adapter

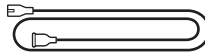

Power cord*

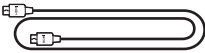

HDMI cable

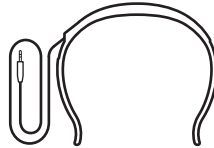

ADAPTiQ headset

*May ship with multiple power cords. Use the power cord for your region.

NOTE: If any part of the product is damaged, do NOT use it. Contact your authorized Bose dealer or Bose customer service.

Visit: worldwide.Bose.com/Support/SB500

RECOMMENDATIONS

For best performance, follow these recommendations when placing the soundbar:

- Do NOT place any objects on top of the soundbar.
- To avoid wireless interference, keep other wireless equipment 1 – 3 ft. (0.3 – 0.9 m) away from the soundbar. Place the soundbar outside and away from metal cabinets, other audio/video components and direct heat sources.
- Place the soundbar directly below (preferred) or above your TV with the grille facing into the room.
- Place the soundbar on its rubber feet on a stable and level surface. For proper support, both feet must be resting on the surface. Vibration can cause the soundbar to move, particularly on smooth surfaces like marble, glass or highly polished wood.
- Keep the back side of the soundbar at least 0.4 in. (1 cm) from any other surface. Blocking the ports on this side affects acoustic performance.
- Make sure there is an AC (mains) outlet nearby.
- For best sound quality, do NOT place the soundbar in an enclosed cabinet or diagonally in a corner.
- If placing the soundbar on a shelf or TV stand, position the front of the soundbar as close as possible to the front edge of the shelf or TV stand for optimal acoustic performance.

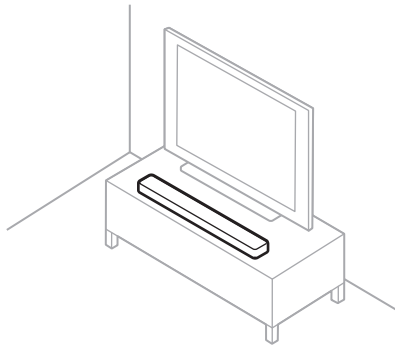

CAUTION: Do NOT place the soundbar on its front, back or top when in use.

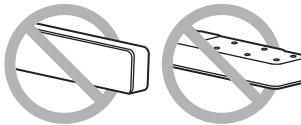

WALL MOUNT THE SOUNDBAR

You can mount the soundbar on a wall. To purchase the Bose Soundbar Wall Bracket, contact your authorized Bose dealer.

Visit: worldwide.bose.com/Support/SB500

CAUTION: Do NOT use any other hardware to mount the soundbar.

CONNECT THE SOUNDBAR TO POWER

1. Connect the power cord to the AC power adapter.
2. Connect the AC power adapter to the Power connector  on the back of the soundbar.
3. Plug the other end of the power cord into an AC (mains) power outlet.

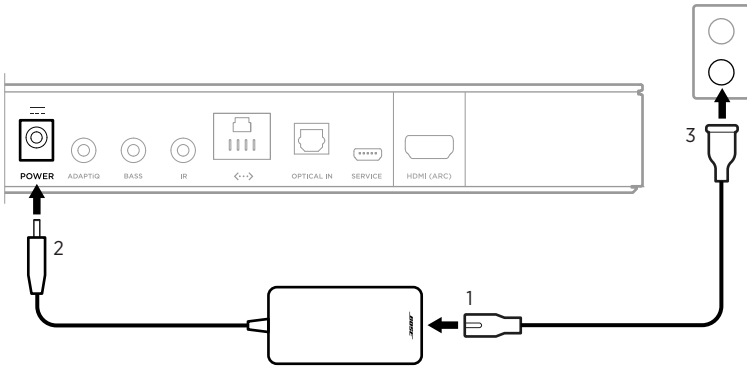

The soundbar powers on and the light bar glows solid amber.

NETWORK STANDBY

The soundbar transitions to network standby when audio has stopped and you have not pressed any buttons for 20 minutes. To wake the soundbar from network standby:

- Play or resume audio using your mobile device or using the Bose Music app.
- Talk to Amazon Alexa or your Google Assistant.
- On the remote, press the Power  button, source button (see page 21) or preset button (see page 23).

NOTES:

- To access your voice assistant in network standby, make sure the soundbar is set up using the Bose Music app and the microphone is on (see page 26).
- You can disable the standby timer using the Bose Music app.

The Bose Music app lets you set up and control the soundbar from your mobile device, such as a smartphone or tablet.

Using the app, you can stream music, set and change presets, add music services, explore internet radio stations, configure Amazon Alexa or your Google Assistant, and manage soundbar settings.

NOTE: If you have already created a Bose account in the Bose Music app for another Bose product, see “Existing Bose Music App Users” on page 18.

DOWNLOAD THE BOSE MUSIC APP

1. On your mobile device, download the Bose Music app.



2. Follow the app instructions.

ADD THE SOUNDBAR TO AN EXISTING ACCOUNT



1. In the Bose Music app, from the **My Bose** screen, tap +.

NOTE: To return to the **My Bose** screen, tap  in the top-left corner of the screen.

2. Follow the app instructions.

CONNECT TO A DIFFERENT WI-FI NETWORK

Connect to a different network if your network name or password has changed, or if you want to change or add another network.

1. On the remote, press and hold the TV button  and Skip backward button  until the light bar glows amber.
2. On your mobile device, open your Wi-Fi settings.
3. Select Bose Soundbar 500.
4. Open the Bose Music app, and follow the app instructions.

NOTE: If the app doesn't prompt you to set up your soundbar, tap the **My Bose** icon in the top-left corner. Tap + to add your product.

After you set up the soundbar using the Bose Music app, the app prompts you to run ADAPTIQ audio calibration for best acoustic performance. ADAPTIQ audio calibration customizes the sound of the system to the acoustics of your listening area by taking five audio measurements. To run an audio calibration, you need 10 minutes when the room is quiet.

During ADAPTIQ audio calibration, a microphone on the top of the ADAPTIQ headset (provided with the soundbar) measures the sound characteristics of your room to determine optimal sound quality.

RUN ADAPTIQ AUDIO CALIBRATION USING THE BOSE MUSIC APP

If you later connect an optional bass module or surround speakers, move the soundbar or move any furniture, run ADAPTIQ audio calibration again to ensure optimal sound quality.

1. In the Bose Music app, from the **My Bose** screen, select your soundbar.
2. Tap the soundbar image on the bottom-right corner of the screen.
3. Tap **Settings > ADAPTIQ > Run Again**.
4. Follow the app instructions.

The soundbar controls are located on the top of the soundbar and on the remote.

NOTE: You can also control your soundbar using the Bose Music app.

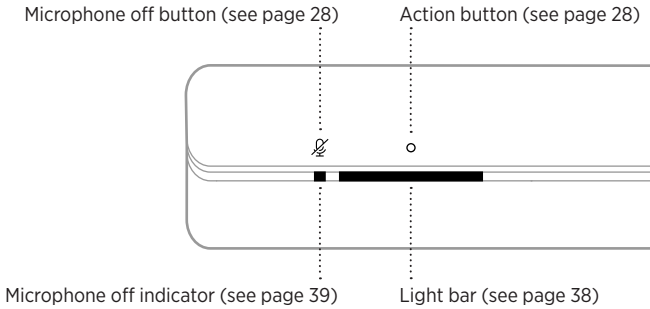

VOICE ASSISTANT CONTROLS

You can use the Action button  and Microphone off button  to control Amazon Alexa (see page 28) or your Google Assistant (see page 30).

REMOTE FUNCTIONS

Use the remote to control the soundbar, *Bluetooth* connections, and presets.

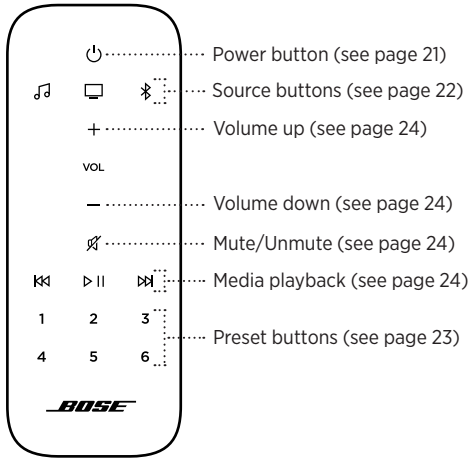

Power

To power the soundbar on/off, press the Power button  on the remote.

When powered on, the soundbar defaults to the last active source.

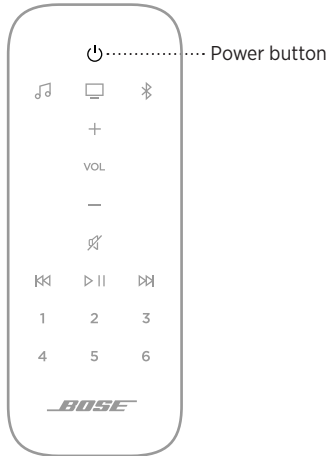

NOTES:

- When you plug the soundbar into an AC (mains) outlet, the soundbar automatically powers on.
- The first time the soundbar is powered on, the soundbar defaults to TV  source.
- You can still access your voice assistant when the soundbar is powered off as long as it has been set up using the Bose Music app and the microphone is on (see page 26).

Sources

You can control your Bose Music presets and *Bluetooth* connections using your remote.

To control a source, on the remote, press the button (Bose Music 🎵 or *Bluetooth* 📶) for the source you want to control.

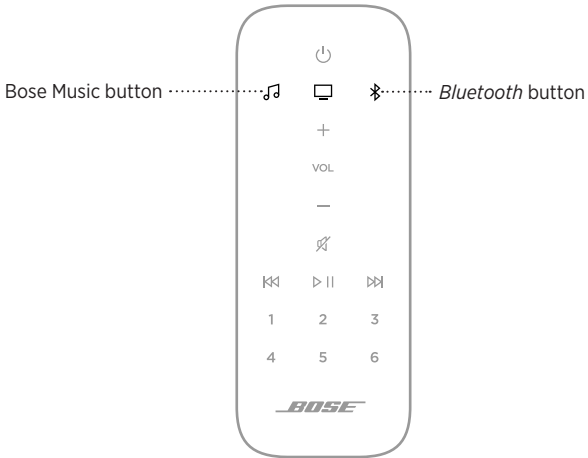

Presets

The soundbar includes six presets that you can set to play audio from your favorite music services. Once set, you can access your music, at any time, with a simple touch of a button on the remote or using the Bose Music app.

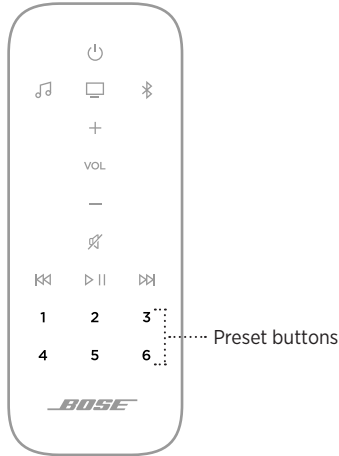

For more information about presets, see “Preset Personalization” on page 32.

Media playback and volume

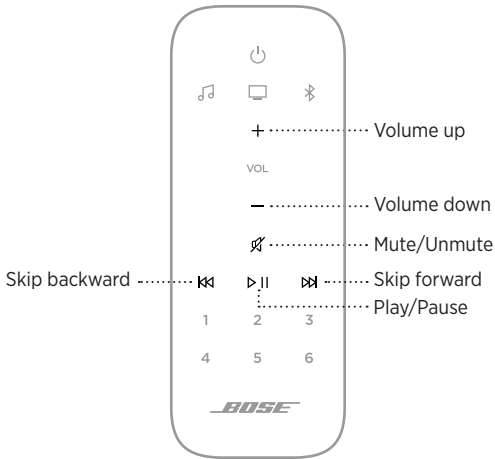

FUNCTION	WHAT TO DO
Play/Pause	Press ▷ . When audio is paused, the sides of the light bar glow solid white until audio resumes.
Skip backward	Press ◀◀.
Skip forward	Press ▶▶.
Volume up	Press +. NOTE: To quickly increase the volume, press and hold +.
Volume down	Press -. NOTE: To quickly decrease the volume, press and hold -.
Mute/Unmute	Press 🔇. When audio is muted, the sides of the light bar glow solid white until audio resumes. NOTE: You can also press + to resume audio.

ADJUST THE BASS

1. In the Bose Music app, from the **My Bose** screen, select your soundbar.
2. Tap the soundbar image in the bottom-right corner of the screen.
3. Tap **Adjustments** to adjust the bass.

PROGRAM A THIRD-PARTY REMOTE

You can program a third-party remote, such as your cable/satellite box remote, to control the soundbar. Refer to your third-party remote owner's guide or website for instructions.



Once programmed, the third-party remote controls basic soundbar functions such as power on/off and volume.

NOTE: Not all third-party remotes are compatible with the soundbar. The remote must support IR (infrared) signals in order to control the soundbar.

VOICE ASSISTANT OPTIONS

You can program your soundbar to quickly and easily access Amazon Alexa or your Google Assistant.

NOTE: Amazon Alexa and the Google Assistant aren't available in certain languages and countries.

OPTIONS	HOW TO USE
Amazon Alexa	Use your voice and/or the Action button  (see page 28).
Your Google Assistant	Use voice and/or the Action button  (see page 30).

NOTE: You can't set the soundbar to access Amazon Alexa and the Google Assistant at the same time.

SET UP YOUR VOICE ASSISTANT

Before you begin, make sure your mobile device and the soundbar are connected to the same Wi-Fi network.

To set up your voice assistant, use the Bose Music app. You can access this option from the Settings menu.

NOTE: When setting up your voice assistant, make sure you use the same audio service account that you used in the Bose Music app.

ACCESS ALEXA

The soundbar is Amazon Alexa enabled. With Alexa, you can ask to play music, hear the news, check the weather, control smart home devices and more. Using Alexa on your soundbar is as simple as asking. Just ask or use the Action button  and Alexa responds instantly.

For more information about what Alexa can do, visit:

<https://www.amazon.com/usealexa>



NOTE: Alexa isn't available in certain languages and countries.

Use your voice

Start with "Alexa," then say:

THINGS TO TRY	EXAMPLE OF WHAT TO SAY
Talk to Alexa	What's the weather?
Play audio	Play Beethoven. NOTE: Amazon Music is set as the default music service. To change the default music service, use the Alexa app.
Control volume	Turn the volume up.
Play from a specific audio service	Play NPR on TuneIn. NOTE: Amazon Alexa doesn't support all audio services.
Play on a specific speaker	Play funk in the living room. NOTE: Make sure you say the speaker name you assigned in the Bose Music app. If multiple speakers have the same name, use the name assigned in the Alexa app or change the name in the Bose Music app.
Skip to the next song	Next song.
Set a timer	Set a timer for 5 minutes.
Discover more skills	What new skills do you have?
Stop Alexa	Stop.



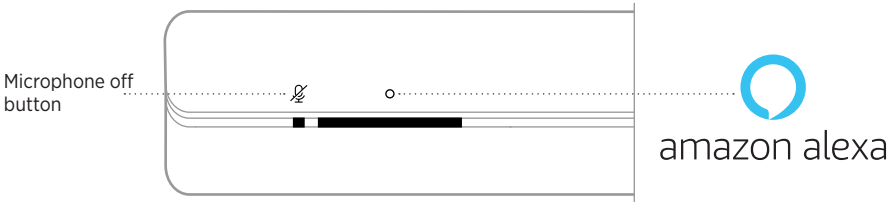

Use the soundbar controls

The Action button  and Microphone off button  are used to control Alexa. They are located on the top of the soundbar.



THINGS TO TRY

WHAT TO DO

Talk to Alexa	Tap  then say your request. For a list of things to try, visit: https://www.amazon.com/usealexa
Stop alarms and timers	Tap  .
Stop Alexa	Tap  .
Turn the microphone on/off	Tap  . NOTE: When the microphone is off,  glows solid red, and you can't access Alexa.

ACCESS YOUR GOOGLE ASSISTANT

Get hands-free help from your Bose Soundbar 500, which now works with your Google Assistant so you can pause and play your favorite media using just your voice.

For more information on what your Google Assistant can do, visit:
<https://support.google.com/assistant>

NOTE: The Google Assistant isn't available in certain languages and countries.

Use your voice

Start with "Hey Google," then say:

THINGS TO TRY	EXAMPLES OF WHAT TO SAY
Access Google's smarts	How do you say friend in Spanish?
Have family fun	What noise does an elephant make?
Set a reminder	Remind me to call mom on Thursday.
Check your calendar	How does my day look?
Control your smart home	Turn off the lights.



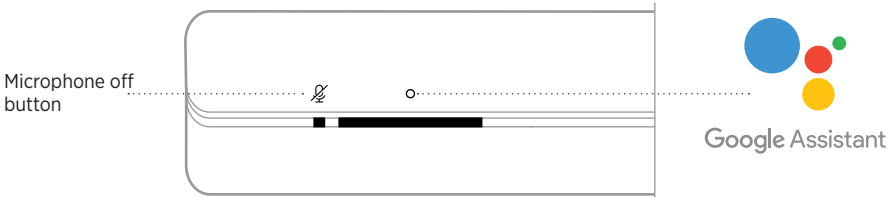

Use the soundbar controls

You can use the Action button  and Microphone off button  to control your Google Assistant. They are located on the top of the soundbar.



THINGS TO TRY

WHAT TO DO

Talk to your Google Assistant	Tap  then say your request. For a list of things to try, visit: https://support.google.com/assistant
Stop alarms and timers	Tap  .
Stop your Google Assistant	Tap  .
Turn the microphone on/off	Tap  . When the microphone is off,  glows solid red, and you can't access your Google Assistant.

PLAY MUSIC WITH YOUR GOOGLE ASSISTANT

You can ask your Google Assistant to play music from your default audio service or from a specific audio service.

Start with “Hey Google,” then say:

THINGS TO TRY	EXAMPLES OF WHAT TO SAY
Play music	Play jazz. NOTE: The Google Assistant uses your default audio service. To change the default audio service, use the Google Assistant app.
Control your speaker	Turn it up.
Play from a specific audio service	Play NPR on TuneIn. NOTE: The Google Assistant doesn't support all audio services.
Play on a specific speaker	Play hip-hop in the kitchen. NOTE: Make sure you say the speaker name you assigned in the Bose Music app. If multiple speakers have the same name, use the name assigned in the Google Assistant app or change the name in the Bose Music app.

Choose a default audio service

During initial setup for your Google Assistant, the Google Assistant app prompts you to select a default audio service. When using your Google Assistant with Bose products, only Pandora and Spotify are supported default services. Although other audio services are listed as available during setup, they are not supported.

For the best experience, choose Pandora or Spotify as your default audio service. If you choose an unsupported audio service, you hear an error message when requesting to play music.

You can control presets using the Bose Music app or the remote.

NOTE: You can't set presets in *Bluetooth* mode.

SET A PRESET

1. Stream music using the Bose Music app.
2. On the remote, press the Bose Music button .

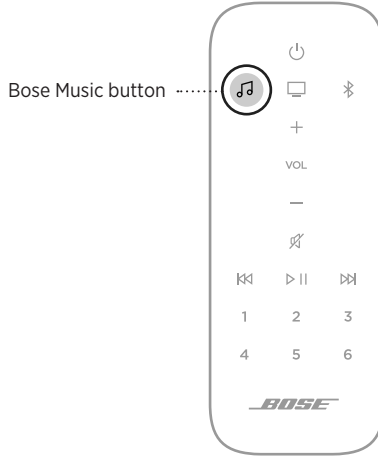

3. Press and hold a preset button until you hear a tone.

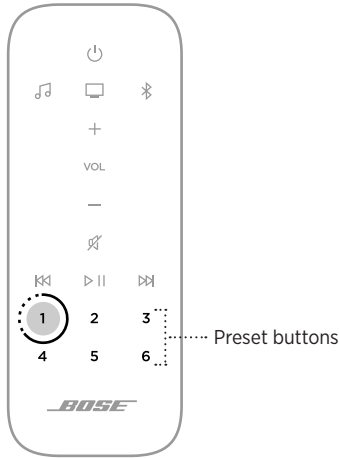

PLAY A PRESET

Once you personalize presets, press a preset button on the remote to play music.

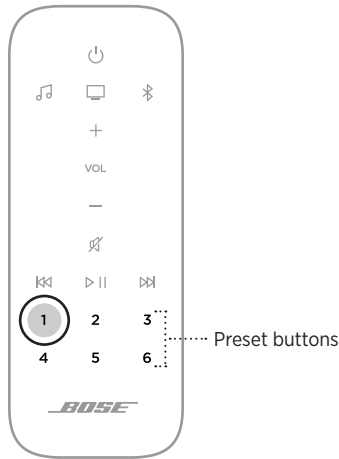

Bluetooth wireless technology lets you stream music from mobile devices such as smartphones, tablets, and laptop computers. Before you can stream music from a device, you must connect your device to the soundbar.

CONNECT A MOBILE DEVICE

1. On the remote, press the *Bluetooth* button .

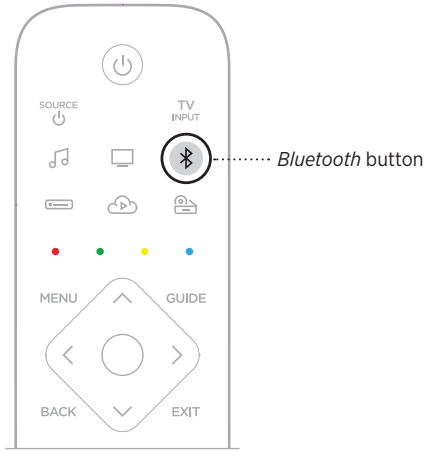

The light bar pulses blue.

2. On your mobile device, turn on the *Bluetooth* feature.

TIP: The *Bluetooth* menu is usually found in the Settings menu.

3. Select your soundbar from the device list.

TIP: Look for the name you entered for your soundbar in the Bose Music app. If you didn't name your soundbar, the default name appears.



Once connected, you hear a tone. The light bar glows solid white then fades to black. The soundbar's name appears in the mobile device list.

DISCONNECT A MOBILE DEVICE

Use the Bose Music app to disconnect your mobile device.

TIP: You can also use *Bluetooth* settings on your mobile device. Disabling the *Bluetooth* feature disconnects all other devices.

RECONNECT A MOBILE DEVICE

On the remote, press the *Bluetooth* button .

The soundbar tries to connect with the most recently connected device.

NOTES:

- Make sure the Bluetooth feature is enabled on your mobile device.
- The device must be within 30 ft. (9 m) and powered on.

CONNECT AN ADDITIONAL MOBILE DEVICE

You can store up to eight devices in the soundbar device list, and the soundbar can be actively connected to two devices at a time.

NOTE: You can play audio from only one device at a time.

1. On the remote, press and hold the *Bluetooth* button .

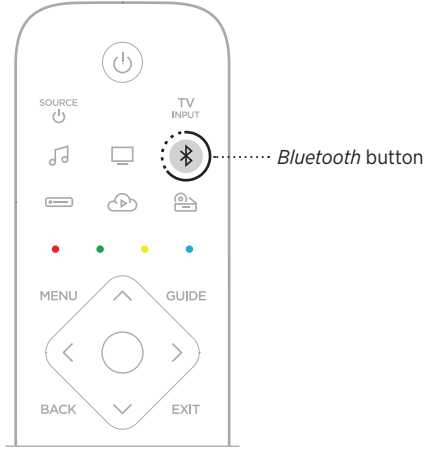

The light bar pulses blue.

2. On your mobile device, select your soundbar from the device list.

NOTE: Make sure the *Bluetooth* feature is enabled on your mobile device.

CLEAR THE SOUNDBAR DEVICE LIST

1. Tap and hold  for 10 seconds until the light bar pulses white twice then fades to black.

The light bar pulses blue.

2. Delete the soundbar from the *Bluetooth* list on your device.

All devices are cleared, and the soundbar is ready to connect (see page 34).

The soundbar is capable of playing AirPlay 2 audio, which allows you to quickly stream audio from your Apple device to the soundbar or multiple speakers.

NOTES:

- To use AirPlay 2, you need an Apple device running iOS 11.4 or later.
- Your Apple device and soundbar must be connected to the same Wi-Fi network.
- For more information about AirPlay, visit: <https://www.apple.com/airplay>

STREAM AUDIO FROM THE CONTROL CENTER

1. On your Apple device, open the Control Center.
2. Tap and hold the audio card in the top-right corner of the screen, then tap the AirPlay icon .
3. Select your soundbar or speakers.

STREAM AUDIO FROM AN APP

1. Open a music app (like Apple Music), and select a track to play.
2. Tap .
3. Select your soundbar or speakers.

The LED light bar located on the front of the soundbar shows the soundbar status.

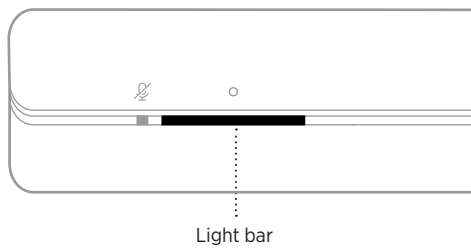

NOTE: The light bar displays one status at a time of the selected source.

WI-FI STATUS

Shows the Wi-Fi connection status of the soundbar.

LIGHT BAR ACTIVITY		SYSTEM STATE
Pulsing white		Connecting to Wi-Fi
Solid white then fades to black		Connected to Wi-Fi





BLUETOOTH STATUS

Shows the *Bluetooth* connection status of mobile devices.

LIGHT BAR ACTIVITY		SYSTEM STATE
Pulsing blue		Ready to connect to mobile device
Pulsing white		Connecting to mobile device
Solid white then fades to black		Connected to mobile device
White light pulses twice then fades to black		Clearing device list

VOICE ASSISTANT STATUS

Shows the status of your voice assistant.

LIGHT BAR ACTIVITY		SYSTEM STATE
Off		Voice assistant is idle
White light slides to the center then glows solid		Voice assistant is listening
White light slides to the sides		Voice assistant is thinking
Pulsing white (full)		Voice assistant is speaking
Pulsing yellow		Notification from voice assistant

Microphone off indicator

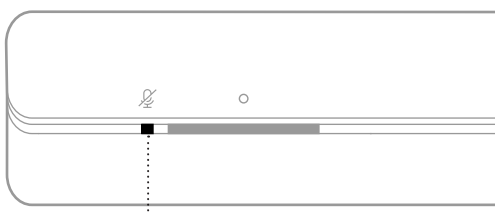



Microphone off indicator

INDICATOR ACTIVITY	SYSTEM STATE
Solid red	The microphone is off



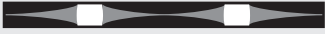



MEDIA PLAYBACK AND VOLUME

Shows the soundbar status when controlling media playback and volume.

LIGHT BAR ACTIVITY		SYSTEM STATE
Two center lights glow solid white		Play/Pause
Right end of the light bar pulses white		Volume up
Left end of the light bar pulses white		Volume down

UPDATE AND ERROR STATUS



Shows the status of software updates and error alerts.

LIGHT BAR ACTIVITY		SYSTEM STATE
Solid amber		Wi-Fi setup in progress
White light slides from right to left		Downloading update
White light slides from left to right		Updating soundbar
Pulses amber four times		Source error - refer to the Bose Music app
Pulses red four times		Request is temporarily unavailable - try again later
Solid red		Soundbar error - contact Bose customer service

UPDATE THE SOUNDBAR

The soundbar updates automatically when connected to the Bose Music app and to your Wi-Fi network.

DISABLE/ENABLE WI-FI CAPABILITY

On the remote, press and hold the Bose Music button  and Skip forward button  until the light bar pulses white twice then fades to black.

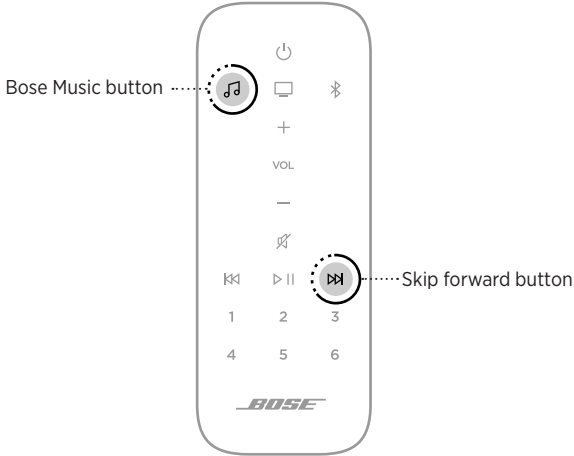

CONNECT ACCESSORIES (OPTIONAL)

You can connect any of these accessories to your soundbar. For more information, refer to your accessory owner's guide.

- **Bose Bass Module 500:** worldwide.bose.com/Support/BASS500
- **Bose Bass Module 700:** worldwide.bose.com/Support/BASS700
- **Acoustimass 300 bass module:** global.bose.com/Support/AM300
- **Bose Surround Speakers:** worldwide.bose.com/Support/WSS
- **Virtually Invisible 300 wireless surround speakers:**
global.bose.com/Support/VI300
- **Bose Soundbar Universal Remote:** worldwide.bose.com/Support/SB500

INSTALL THE REMOTE BATTERIES

1. Slide open the battery compartment cover on the back of the remote.

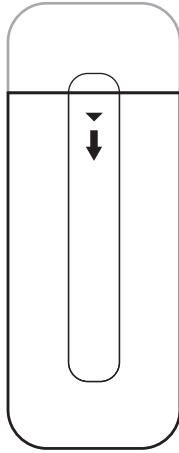

2. Insert the two provided AAA (IEC-LR3) 1.5V batteries. Match the + and – symbols on the batteries with the + and – markings inside the compartment.

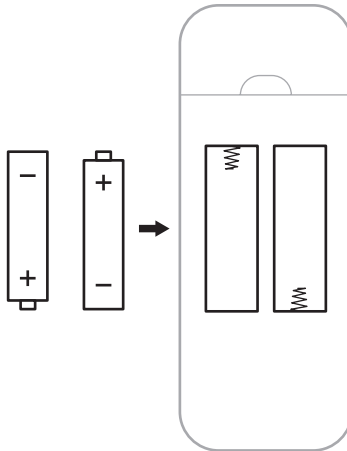

3. Slide the battery compartment cover back into place.

CLEAN THE SOUNDBAR

Clean the exterior of the soundbar with a soft dry cloth.

CAUTIONS:

- Do NOT allow liquids to spill onto the system or into any openings.
- Do NOT blow air into the system.
- Do NOT use a vacuum to clean the system.
- Do NOT use any sprays near the system.
- Do NOT use any solvents, chemicals or cleaning solutions containing alcohol, ammonia or abrasives.
- Do NOT allow objects to drop into any openings.

REPLACEMENT PARTS AND ACCESSORIES

Replacement parts and accessories can be ordered through Bose customer service.

Visit: worldwide.Bose.com/Support/SB500

LIMITED WARRANTY

The soundbar is covered by a limited warranty. Visit our website at global.Bose.com/warranty for details of the limited warranty.

To register your product, visit global.Bose.com/register for instructions. Failure to register will not affect your limited warranty rights.

TRY THESE SOLUTIONS FIRST

If you experience problems with the soundbar:

- Make sure the soundbar is connected to a live AC (mains) outlet.
- Secure all cables.
- Verify the state of the light bar (see page 38).
- Move the soundbar away 1 – 3 ft. (0.3 – 0.9 m) from possible interference (wireless routers, cordless phones, televisions, microwaves, etc.).
- Move the soundbar within the recommended range of your wireless router or mobile device for proper operation.
- Place the soundbar according to the placement guidelines (see page 14).

OTHER SOLUTIONS

If you could not resolve your issue, see the table below to identify symptoms and solutions to common problems. If you are unable to resolve your issue, contact Bose customer service.

Visit: worldwide.Bose.com/contact

SYMPTOM	SOLUTION
No HDMI eARC (or ARC) or optical connector on your TV	Connect to your TV using an audio converter and separate audio cable, such as a coaxial, 3.5 mm or analog audio cable (not provided). The type of converter and cable you need depends on the audio output connectors available on your TV.
Soundbar doesn't power on	<p>Plug the power cord into a different AC (mains) outlet.</p> <p>Use the remote to power on the soundbar (see page 21).</p> <p>Unplug the power cords for the soundbar and optional bass module or surround speakers, wait 30 seconds and firmly plug them into the AC (mains) outlet.</p>
Remote is inconsistent or doesn't work	<p>Match the + and – symbols on the batteries with the + and – markings inside the compartment (see page 43).</p> <p>Replace the batteries (see page 43).</p> <p>Make sure the remote is within operating range 20 ft. (6 m) of the soundbar.</p> <p>Make sure there are no obstructions between the remote and the soundbar.</p>

SYMPTOM	SOLUTION
<p>Intermittent or no audio</p>	<p>If the sides of the light bar are pulsing, the soundbar is muted. Press the Mute/Unmute button  to unmute the soundbar.</p> <p>Make sure your mobile device is not muted.</p> <p>Increase the volume on the soundbar (see page 24) or your mobile device.</p> <p>Switch to a different source (see page 22).</p> <p>Play audio from a different application or music service.</p> <p>If the audio is from a Wi-Fi source, reset the router.</p> <p>Restart your mobile device.</p> <p>Make sure you're using a compatible <i>Bluetooth</i> mobile device.</p> <p>NOTE: You can't connect <i>Bluetooth</i> headphones to the soundbar.</p> <p>Make sure that the soundbar's HDMI cable is inserted into a connector on your TV labeled HDMI eARC or ARC (Audio Return Channel), not a standard HDMI connector. If your TV does not have an HDMI eARC or ARC connector, connect the soundbar using an optical cable (not provided) (see page 54).</p> <p>If the soundbar is connected to your TV's HDMI eARC or ARC connector, make sure that Consumer Electronics Control (CEC) is enabled in your TV system menu. Your TV may refer to CEC by a different name. Refer to your TV owner's guide.</p> <p>Disconnect the soundbar's HDMI cable from your TV's HDMI eARC or ARC connector and reconnect it.</p> <p>Insert the optical cable (not provided) into a connector on your TV labeled Output or OUT, not Input or IN.</p> <p>Unplug the power cords for the soundbar and optional bass module or surround speakers, wait 30 seconds and firmly plug them into the AC (mains) outlet.</p>
<p>Soundbar doesn't connect to bass module or surround speakers</p>	<p>Refer to your bass module or surround speakers owner's guide for troubleshooting (see page 42).</p> <p>Make sure your bass module or surround speakers are compatible with the soundbar (see page 42).</p> <p>Unplug the power cords for the soundbar and optional bass module or surround speakers, wait 30 seconds and firmly plug them into the AC (mains) outlet.</p>

SYMPTOM	SOLUTION
<p>No audio from bass module or surround speakers</p>	<p>Make sure your bass module or surround speakers are compatible with the soundbar (see page 42).</p> <p>Make sure the software is current in the Bose Music app.</p> <p>Adjust the bass level using the Bose Music app (see page 25).</p> <p>Switch to a different source (see page 22).</p>
<p>Sound is coming from TV speaker</p>	<p>Make sure that the soundbar's HDMI cable is inserted into a connector on your TV labeled HDMI eARC or ARC (Audio Return Channel). If your TV does not have an HDMI eARC or ARC connector, connect to the soundbar using an optical cable (not provided) (see page 54).</p> <p>Turn off your TV speakers. Refer to your TV owner's guide.</p> <p>If the soundbar is connected to your TV's HDMI eARC or ARC connector, make sure that Consumer Electronics Control (CEC) is enabled in your TV system menu. Your TV may refer to CEC by a different name. Refer to your TV owner's guide.</p> <p>Disconnect the soundbar's HDMI cable from your TV's HDMI eARC or ARC connector and reconnect it.</p> <p>Decrease your TV volume to its lowest setting.</p> <p>Connect to the soundbar using both the HDMI cable (see page 53) and optical cable (not provided) (see page 54).</p>
<p>Poor or distorted audio</p>	<p>Test different sources if available.</p> <p>Make sure that your TV can output surround sound audio. Refer to your TV owner's guide.</p> <p>If the audio is being played from another device, reduce the volume of that device.</p> <p>Adjust the bass level using the Bose Music app (see page 25).</p> <p>Power off your TV speakers. Refer to your TV owner's guide.</p> <p>Run ADAPTiQ audio calibration (see page 19).</p>
<p>Soundbar doesn't play audio from the correct source or selects the incorrect source after a delay</p>	<p>Set CEC to Alternate using the Bose Music app.</p> <p>Disable CEC on your source. Refer to the source owner's guide for more information.</p> <p>Connect to the soundbar using both the HDMI cable (see page 53) and optical cable (not provided) (see page 54).</p>



SYMPTOM	SOLUTION
<p>Soundbar doesn't connect to Wi-Fi network</p>	<p>In the Bose Music app, select correct network name, and enter the network password (case-sensitive).</p> <p>Make sure the soundbar and your mobile device are connected to the same Wi-Fi network.</p> <p>If your network information has changed, see page 18.</p> <p>Enable Wi-Fi on the mobile device you are using for setup.</p> <p>Close other open applications on your mobile device.</p> <p>Restart your mobile device and router.</p> <p>If your router supports both 2.4GHz and 5GHz bands, make sure both your mobile device and the soundbar are connecting to the same band.</p> <p>NOTE: Give each band a unique name to make sure you're connecting to the correct band.</p> <p>Reset the router.</p> <p>Unplug the power cords for the soundbar and optional bass module or surround speakers, wait 30 seconds and firmly plug them into the AC (mains) outlet. Uninstall the Bose Music app on your mobile device, reinstall the app and restart setup.</p> <p>Connect to the network using an Ethernet cable.</p>
<p>Soundbar doesn't connect to Bluetooth device</p>	<p>On your mobile device, turn the <i>Bluetooth</i> feature off and then on. Delete the soundbar from the <i>Bluetooth</i> list. Connect again (see page 34).</p> <p>Connect a different mobile device (see page 34).</p> <p>Make sure you're using a compatible <i>Bluetooth</i> mobile device.</p> <p>NOTE: You can't connect <i>Bluetooth</i> headphones to the soundbar.</p> <p>Remove the soundbar from your mobile device <i>Bluetooth</i> device list and connect again (see page 34).</p> <p>Clear the soundbar device list (see "Clear the soundbar device list" on page 36) and connect again (see page 34).</p>
<p>Soundbar doesn't stream audio using AirPlay</p>	<p>Make sure your soundbar is powered on and in range (see page 16).</p> <p>Make sure your Apple device and your soundbar are connected to the same Wi-Fi network.</p> <p>Update your Apple device.</p> <p>Make sure the soundbar is up-to-date (see page 41).</p> <p>If you can't find the AirPlay icon  in the music app you are streaming from, stream audio from the Control Center.</p> <p>For additional support, visit: https://www.apple.com/airplay</p>

SYMPTOM	SOLUTION
Bose Music app doesn't work on mobile device	<p>Make sure your mobile device is compatible with the Bose Music app and meets minimum system requirements. For more information, refer to the app store on your mobile device.</p> <p>Uninstall the Bose Music app on your mobile device then reinstall the app (see page 17).</p>
Soundbar isn't visible to add to another Bose account	<p>Make sure sharing is enabled on your soundbar using the Bose Music app.</p> <p>Make sure the soundbar and your mobile device are connected to the same Wi-Fi network.</p>
Alexa doesn't respond	<p>Make sure Alexa has been set up using the Bose Music app (see page 26).</p> <p>NOTE: The soundbar must be set up and connected to your Wi-Fi network using the Bose Music app.</p> <p>Make sure you're in a country where Amazon Alexa is available.</p> <p>Make sure the Microphone off indicator is not glowing red. To turn on the microphone, see page 39.</p> <p>Make sure you say the name you assigned in the Bose Music app. If multiple speakers have the same name, use the name assigned in the Alexa app or change the name in the Bose Music app.</p> <p>For additional support, visit: https://www.amazon.com/usealexa</p>
Your Google Assistant doesn't respond	<p>Make sure your Google Assistant has been set up using the Bose Music app (see page 26).</p> <p>Connect your mobile device to Wi-Fi.</p> <p>Make sure you're in a country where the Google Assistant is available.</p> <p>Make sure you are using the most up-to-date version of the Google Assistant app.</p> <p>Make sure your mobile device is compatible.</p> <p>Remove your Google Assistant from the system using the Bose Music app. Then, add your Google Assistant again.</p> <p>Choose Pandora or Spotify as your default audio service (see page 31).</p> <p>Make sure you use the same audio service account on the Bose Music app and Google Assistant app.</p> <p>Your Google Assistant may not support your request. New features are added periodically.</p> <p>For additional support, visit: https://support.google.com/assistant</p>

SYMPTOM	SOLUTION
Change your Google Assistant personal result settings	To turn off personal results or change the account for personal results, use the Settings menu in the Google Assistant app.
Preset doesn't respond	Make sure the preset has been set (see page 32). Press the Bose Music button  to make sure the soundbar is in the correct source.

RESET THE SOUNDBAR

Factory reset clears all source, volume, network and ADAPTiQ audio calibration settings from the soundbar and returns it to original factory settings.

1. On the remote, press and hold the Power button  and Skip forward button  for 5 seconds until light bar pulses white twice then fades to black.

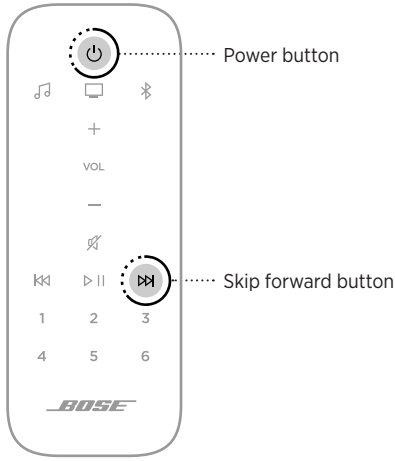

The soundbar reboots. When the reset is complete, the light bar glows solid amber.

2. To restore the soundbar's network and audio settings:
 - a. Launch the Bose Music app on your mobile device and add the soundbar to your network (see "Existing Bose Music App Users" on page 18).
 - b. Run ADAPTiQ audio calibration using the Bose Music app.

CONNECTION OPTIONS

Connect the soundbar to your TV using one of the following connection options:

Option 1 (preferred): HDMI eARC or ARC (Audio Return Channel)

Option 2: Optical (not provided)

NOTE: The preferred option is to connect the soundbar to your TV's HDMI eARC or ARC connector using the HDMI cable.

1. On the back of your TV, locate the **HDMI IN** and **Audio OUT** (optical) connector panels.

NOTE: Your TV's connector panel may not appear as shown. Look for the shape of the connector.

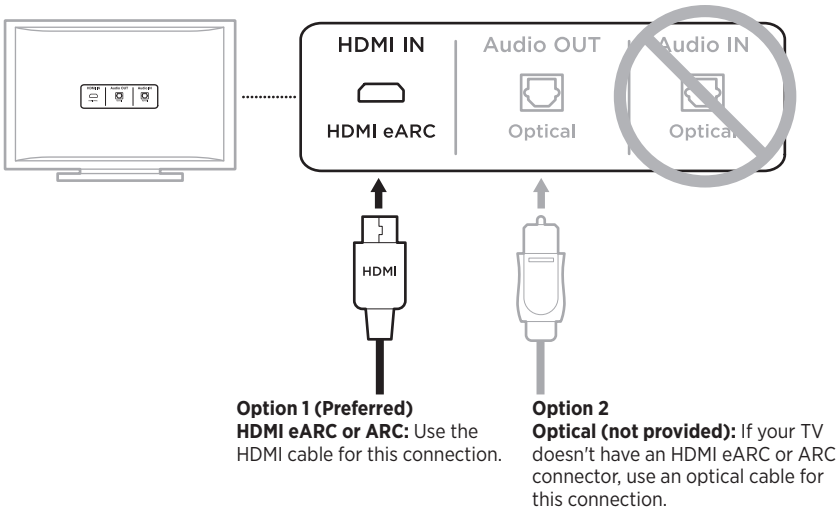

2. Choose an audio cable.

CONNECT THE SOUNDBAR TO YOUR TV

After choosing an audio cable, connect the soundbar to your TV.

Option 1 (preferred): HDMI eARC or ARC

1. Insert one end of the HDMI cable into your TV's **HDMI eARC** or **ARC** connector.

NOTE: Make sure you insert the HDMI cable into an HDMI ARC connector on your TV, not a standard HDMI connector. If your TV does not have an HDMI eARC or ARC connector, see page 54.

2. Insert the other end of the cable into the **HDMI (ARC)** connector on the soundbar.

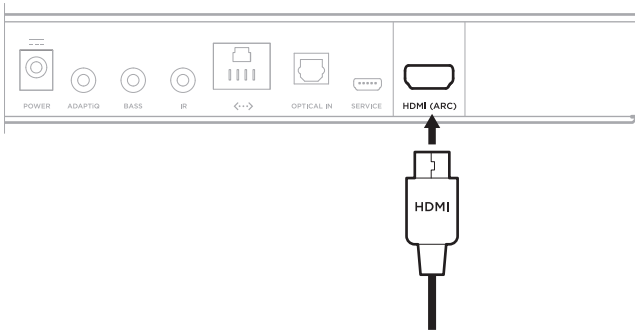

Option 2: Optical (not provided)

If your TV doesn't have an HDMI eARC or ARC connector, use an optical cable (not provided) to connect the soundbar to your TV.

1. Remove the protective cap from both ends of the optical cable.

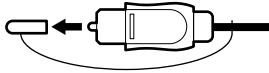

CAUTION: Inserting the plug in the wrong orientation can damage the plug and/or the connector.

2. Insert one end of the optical cable into your TV's **Optical OUT** connector.
3. Hold the plug at the other end of the optical cable.
4. Align the plug with the soundbar's **OPTICAL IN** connector, and insert the plug carefully.

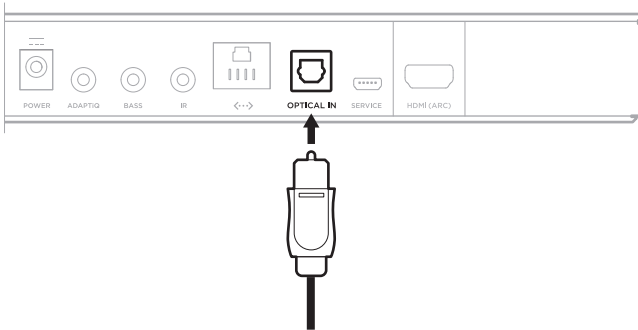



NOTE: The connector has a hinged door that swings inward when inserting the plug.

5. Firmly push the plug into the connector until you hear or feel a click.



CHECK FOR SOUND

NOTE: To avoid hearing distorted audio, turn off your TV speakers. Refer to your TV owner's guide for more information.

1. Power on your TV.
 2. If you are using a cable/satellite box or other secondary source:
 - a. Power on this source.
 - b. Select the appropriate TV input.
 3. If the soundbar is not powered on, press the Power button  on the remote.
You hear sound coming from the soundbar.
 4. Press the Mute/Unmute button .
- You don't hear sound coming from the TV speakers or soundbar.

NOTE: If you don't hear sound coming from the soundbar or hear sound coming from your TV speakers, see page 47.



810604-0010