

# Contents

<b>1 Instructions</b>	<b>26</b>
1.1 General safety instructions	26
1.2 Manufacturer liability	27
1.3 Appliance purpose	27
1.4 Disposal	27
1.5 Identification plate	28
1.6 This user manual	28
1.7 How to read the user manual	28
<b>2 Description</b>	<b>29</b>
2.1 General Description	29
<b>3 Use</b>	<b>31</b>
3.1 Instructions	31
3.2 Preliminary operations	32
3.3 Using the hob	32
<b>4 Cleaning and maintenance</b>	<b>39</b>
4.1 Instructions	39
4.2 Cleaning the surfaces	39
4.3 Ordinary weekly cleaning	39
4.4 Food stains or residues	39
4.5 What to do if...	40
<b>5 Installation</b>	<b>41</b>
5.1 Electrical connection	41
5.2 Safety instructions	42
5.3 Section cut from the work surface	43
5.4 Mounting	44
5.5 Fixing brackets	46

We advise you to read this manual carefully, which contains all the instructions for maintaining the appliance's aesthetic and functional qualities.

For further information on the product: [www.smeg.com](http://www.smeg.com)



# Instructions

## 1 Instructions

### 1.1 General safety instructions

#### Risk of personal injury

- During use the appliance and its accessible parts become very hot.
- Never touch the heating elements during use.
- Keep children under eight years of age at a safe distance if they are not constantly supervised.
- Children must never play with the appliance.
- Never rest metallic objects such as knives, forks, spoons and lids on the appliance during use.
- Switch off the appliance immediately after use.
- Never try to put out a fire or flames with water: Turn off the appliance and smother the flames with a fire blanket or other appropriate cover.
- The appliance must never be cleaned by unsupervised children.
- Have qualified personnel carry out installation and assistance interventions according to the standards in force.

- Do not modify this appliance.
- Do not insert pointed metal objects (cutlery or utensils) into the slots in the appliance.
- Do not try to repair the appliance yourself or without the intervention of a qualified technician.
- If the power supply cable is damaged, contact technical support immediately and they will replace it.

#### Risk of damaging the appliance

- Do not use abrasive or corrosive detergents on glass parts (e.g. powder products, stain removers and metallic sponges).
- Use wooden or plastic utensils.
- Do not seat on the appliance.
- Do not use steam jets to clean the appliance.
- Do not obstruct ventilation openings and heat dispersal slots.
- Never leave the appliance unattended during cooking operations where fats or oils could be released.
- Never leave objects on the cooking surface.
- Do not use the appliance to heat rooms for any reason.



## For this appliance

- If your hob has a cookware detector, do not rely on it exclusively.
- Remove any traces of liquid from the lid (if fitted) before opening.
- Let the cooking surface cool down before closing the lid.
- If cracks or fissures form, or if the glass ceramic cooking surface breaks, turn off the appliance immediately. Disconnect the power supply and call Technical Support.
- People who have pacemakers or other similar devices fitted must make sure that the operation of these devices is not jeopardised by the inductive field, whose frequency range is between 20 and 50 kHz.
- In conformity with the provisions regarding electromagnetic compatibility, the electromagnetic induction cooking hob comes under group 2 and class B (EN 55011).

## 1.2 Manufacturer liability

The manufacturer declines all liability for damage to persons or property caused by:

- Use of the appliance other than the one envisaged;
- Non-observance of the user manual provisions;
- Tampering with any part of the appliance;
- Use of non-original spare parts.

## 1.3 Appliance purpose

- This appliance is intended for cooking food in the home environment. Every other use is considered improper.
- This appliance may be used by children aged at least 8 and by people of reduced physical and mental capacity, or lacking in experience in the use of electrical appliances, as long they are supervised or instructed by adults who are responsible for their safety.
- The appliance is not designed to operate with external timers or with remote-control systems.

## 1.4 Disposal



This appliance must be disposed of separately from other waste (Directives 2002/95/EC, 2002/96/EC, 2003/108/EC). The appliance does not contain substances in quantities sufficient to be considered hazardous to health and the environment, in accordance with current European directives.

To dispose of the appliance:

- Cut the power supply cable and remove it along with the plug.



### Power voltage

### Danger of electrocution

- Disconnect the main power supply.
- Disconnect the power cable from the electrical system.



# Instructions

- Deliver the appliance to the appropriate recycling centre for electrical and electronic equipment waste, or return it to the retailer when purchasing an equivalent product, on a one for one basis.

Our appliances are packed in non-polluting and recyclable materials.

- Deliver the packing materials to the appropriate recycling centre.



## Plastic packaging Danger of suffocation

- Do not leave the packaging or any part of it unattended.
- Do not let children play with the packaging plastic bags.

## 1.5 Identification plate

The identification plate bears the technical data, serial number and brand name of the appliance. Do not remove the identification plate for any reason.

## 1.6 This user manual

This user manual is an integral part of the appliance and must therefore be kept in its entirety and within the user's reach for the whole working life of the appliance.

Read this user manual carefully before using the appliance.

## 1.7 How to read the user manual

This user manual uses the following reading conventions:

### Instructions



General information on this user manual, on safety and final disposal.

### Description



Description of the appliance and its accessories.

### Use



Information on the use of the appliance and its accessories, cooking advice.

### Cleaning and maintenance



Information for proper cleaning and maintenance of the appliance.

### Installation



Information for the qualified technician: Installation, operation and inspection.



Safety instructions



Information



Advice

1. Use instruction sequence.

- Single use instruction.



## 2 Description

### 2.1 General Description

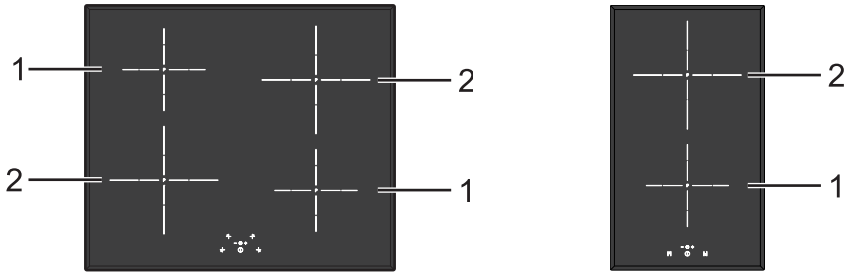

ZEN

Zone	Outer diameter (mm)	Inner diameter (mm)	Max. power consumed (W)*	Consumed power in Power function (W)*
1	160	100	1300	1400
2	210	100	2300	3000

\* power levels are indicative and can vary according to the pan used or the settings made.



### Advantages of induction cooking



The hob is equipped with an induction generator for each cooking zone. Each generator located under the glass ceramic cooking surface creates an electromagnetic field which induces a thermal current in the base of the pan. This means the heat is no longer transmitted from the hob to the pan but created directly inside the pan by the inductive current.

- Energy saving thanks to the direct transmission of energy to the pan (suitable magnetisable cookware is required) compared to traditional electric cooking.
- Improved safety as the energy is only transmitted to the pan placed on the hob.
- High level of energy transmitted from the induction cooking zone to the base of the pan.
- Rapid heating speed.
- Reduced danger of burns as the cooking surface is only heated under the base of the pan; foods which overflow do not stick.



## 3 Use

### 3.1 Instructions



#### High temperature Danger of burns

- Protect your hands wearing heat-proof gloves during use.
- Do not touch or clean the hob surface during operation or when the residual heat indicator lights are still on.
- Do not put empty pans or frying pans on switched on cooking zones.
- Do not allow children younger than 8 years old to come near the appliance when in operation.
- Activate the key lock when you have children or pets which could reach the hob.
- After use the cooking zones remain hot for a certain period of time after they have been turned off. Do not touch the hob surfaces.



#### High temperature Danger of fire or explosion

- Do not use or leave flammable materials near the appliance or directly underneath the hob.
- Do not cook using closed tins or containers, plastic kitchenware or containers.
- Do not leave the appliance unattended during cooking operations where fats or oils could be released.
- In case you notice cracks or fissures or you cannot turn off the appliance, disconnect the power supply and contact the Assistance Centre.



#### Improper use Risk of damage to surfaces

- Do not use the hob if the pyrolytic cycle is taking place inside any oven installed below.
- Never place pans with bases which are not perfectly flat and smooth.
- Avoid hard, solid objects falling on the cooking surface.
- In case you notice cracks or fissures, turn off the appliance immediately, disconnect the power supply and contact the Assistance Centre.
- Do not use the hob as a support surface.



## 3.2 Preliminary operations

In order to remove any moisture that could have accumulated during the manufacturing process and for the electronic circuits and control keypad to work properly:

1. Remove the protective films from the external surfaces of the appliance and accessories.
2. Remove any labels (apart from the technical data plate).
3. Place a pan full of water on each of the front cooking zones and switch them on to the maximum power setting for at least 30 minutes.
4. After 30 minutes, switch off the front cooking zones and repeat this operation for the rear cooking zones and any central cooking zone.
5. If after carrying out the above operations the controls do not work properly, it might be necessary to extend the operations until the moisture has completely evaporated.

## 3.3 Using the hob



On first connection to the electrical mains, an automatic check will be carried out that will switch on all indicator lights for a few seconds.

All the appliance's control and monitoring devices are located together on the front panel. The induction hob is controlled by means of the Touch Control sensor keys. Lightly touch a symbol on the glass ceramic surface. The buzzer will sound to confirm every effective touch.



On/Off: turns the hob on or off.



Increase: increases the power level or cooking time.



Decrease: reduces the power level or cooking time.



Front left cooking zone



Rear left cooking zone



Rear right cooking zone



Front right cooking zone



Rear cooking zone



Front cooking zone





### Cookware suitable for use in induction cooking

Cookware used on the induction cooking surface must be made of metal, with magnetic properties and a sufficiently large base.

#### Suitable cookware:

- Enamelled steel cookware with thick bases.
- Cast iron cookware with an enamelled base.
- Cookware in multilayer stainless steel, ferritic stainless steel and aluminium with a special base.

#### Unsuitable cookware:

- Copper, stainless steel, aluminium, fireproof glass, wood, ceramic and terracotta cookware.

To see whether the pan is suitable, bring a magnet close to the bottom: if it is attracted, the pan is suitable for induction cooking. If you do not have a magnet, you can put a small amount of water in the pan, place it on a cooking zone and start the hot plate. If the symbol  appears on the display, it means the pan is not suitable.

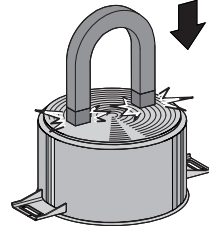

Use only cookware with a perfectly flat bottom and suitable for induction hot plates. Using cookware with an irregular bottom could jeopardise the efficiency of the heating system and prevent cookware from being detected on the hot plate.



## Limiting the cooking duration

The hob has an automatic device which limits the duration of use.

If the cooking zone settings are not changed, the maximum duration of operation for each zone depends on the power level selected.

When the device for limiting the duration of use is activated, the cooking zone turns off, a short alert sounds and, if the zone is hot, the **H** symbol appears on the display.

Set power level	Maximum cooking duration in hours
1 - 2	8
3 - 4	6
5 - 6	5
7	3
8	2
9	1 ½

## Protection from overheating

If the hob is used on full power for a long period, the electronics will have trouble cooling down if the room temperature is high.

To avoid excessively high temperatures forming in the electronics, the power to the cooking zone is reduced automatically.

## Advice on energy-saving

- The diameter of the base of the pan must correspond to the diameter of the cooking zone.



- When buying a pan, check whether the diameter indicated is that of the base or the top of the pan, as the top is almost always larger than the base.
- When preparing dishes with long cooking times, you can save time and energy by using a pressure cooker, which also makes it possible to preserve the vitamins in the food.
- Make sure that the pressure cooker contains enough liquid as, if there is not enough and it overheats, this may cause damage to both the pressure cooker and the cooking zone.
- If possible, always cover pans with a suitable lid.
- Choose a pan suitable for the quantity of food to be cooked. A large, half-empty pan leads to a waste of energy.



Under certain circumstances, if the hob and the oven are being used at the same time, the maximum power limit that can be used by the electrical system might be exceeded.





## Power levels

The power in the cooking zone can be adjusted to various levels. The table shows the levels suitable for various types of cooking.

Power level	Suitable for:
0	OFF setting
1 - 2	Cooking small amounts of food (minimum power)
3 - 4	Cooking
5 - 6	Cooking large quantities of food, roasting larger portions
7 - 8	Roasting, slow frying with flour
9	Roasting
p *	Roasting / browning, cooking (maximum power)

\* see booster function

## Switching the hob on and off



Keep the On/Off key  pressed in for at least 1 second to activate the hob. Keep key  pressed in for at least 2 seconds to deactivate the hob.



If no power value is selected within a few seconds, the hob is automatically deactivated.

## Switching on the cooking zone

After switching on the hob:

1. Select the required cooking zone using the appropriate zone selection keys (e.g. : rear right cooking zone).
2. Use keys  and  to select the cooking power from 1 to 9, or else activate the power function, see " Power Function ".

## Switching off the cooking zone

1. Select the cooking zone you wish to switch off using the zone selection keys.
2. Use the  key to bring the power value to 0 (zero).



Hold the On/Off key  down for at least 2 seconds to switch off all cooking zones at the same time.

## Residual heat



**Improper use**  
**Danger of burns**

- Supervise children carefully as they cannot readily see the residual heat indicator. The cooking zones remain hot for a certain period of time even after they have been turned off. Make sure that children never touch the hob.

If the cooking zone is still hot after being switched off, the symbol  will be displayed on the display. The symbol clears once the temperature drops below 60°C.



## Use

### Power Function



This function allows you to use the maximum possible power for the cooking zone.

After activating the required cooking zone:

1. Press the **+** key to bring the power to 9.
2. Press the **+** key again; the **P** symbol will be shown on the display.

Press key **⏻** to deactivate the Power function.



On the front left and rear right cooking zones only:

The Power function is available for 10 minutes, after which the power level drops automatically to 9.

### Minute minder timer



This function is used to set a minute minder timer, which will sound a buzzer at the end of the pre-set time (from 1 to 99 minutes).

After activating the hob:

1. Press the **+** and **-** keys at the same time; **00** will be displayed.
2. Set the required time in minutes using the **+** and **-** keys (hold the keys down to set the time more quickly). Flashing dots will appear to indicate the count.



Using the minute minder does not switch off the cooking zones but rather informs the user when the set minutes have run out.



The timer can be activated while the cooking zones are on or off.

3. At the end of the previously set time, the hob will warn the user with a series of buzzers. Press any key to stop the buzzer.



To deactivate the minute minder timer during the countdown, zero the set time using key **-**. When the display shows **00** the timer will be deactivated.



## Cooking zone automatic switch-off timer



This function is used to program the automatic switch-off of each cooking zone at the end of a period of time (from 1 to 99 minutes).

1. If the cooking zone is not selected, press keys **+** and **-** at the same time, **00** will appear on the display.
2. Press keys **+** and **-** again; if at least one cooking zone is active, one flashing dot will light up to indicate that the zone is being timed.
3. Select the automatic switch-off time using the **+** and **-** keys (hold the keys down to set the time more quickly), or select an additional zone using keys **+** and **-**.



If the timer is activated without an active cooking zone it behaves like an ordinary minute minder.

4. Press keys **+** and **-** at the same time until a lighted dot appears under the display of the zone whose set time you wish to change. Once the relevant zone is selected, use keys **+** and **-** to change the previously selected time.
5. At the end of the previously set time, the hob will deactivate the cooking zone and warn the user with a series of buzzers. Press any key to stop the buzzer.

## Control lock

After activating the hob:

1. Press keys **-** and **+** / **+** at the same time.
2. Press the **+** / **+** button after the beep.

The controls are now locked and **L** will appear on the display.



In case of a power failure the control lock will be deactivated.

To unlock the controls:

1. Press keys **-** and **+** / **+** at the same time.
2. Press the **-** button after the beep.



# Use

## Power control

To optimise energy consumption, the groups made up of two hot plates are prevented from supplying more than a determined maximum operating power. The electronic circuit will limit the maximum power level which can be selected for the second zone activated.

- It is not possible to activate all zones at the same time.
- Power control priority is given by the first zone set.
- For power control reasons, if the front left hot plate has been switched on it will not be possible to switch on the rear right hot plate as well or vice versa.

## Power control

The hob is fitted with a power control module that optimises/limits consumption. If the overall set power levels exceed the maximum limits permitted, the electronic circuit board controls automatically the power supplied by the hot plates.

The module tries to maintain the maximum deliverable power levels. Levels set by the automatic control will appear on the display.

The flashing of a power level indicates that it will be automatically limited to a new level selected by the power control module.

## Cooking guidelines

The table below shows the power values which can be set, together with the corresponding type of food. Settings may vary depending on the amount of food and consumer taste.

Power level	Suitable for:
1 - 2	Heating food, keeping small amounts of water on the boil, and whipping up sauces with egg yolk or butter.
3 - 4	Cooking solid or liquid food, keeping water on the boil, defrosting deep-frozen food, cooking 2 or 3 egg omelettes, fruit and vegetables, various cooking processes.
5 - 7	Stewing meat, fish and vegetables, simmering food, making jams, etc.
8-9	Roasting meat, fish, steaks and liver; sautéing meat, fish, eggs, etc.
P	Deep-frying potatoes, etc., or bringing water to the boil rapidly.



Priority is given to the last zone set.



The power control module does not affect the total power consumption of the appliance.



## 4 Cleaning and maintenance

### 4.1 Instructions



**Improper use**  
**Risk of damage to surfaces**

- Do not use steam jets to clean the appliance.
- Do not spill sugar or sweet mixtures on the hob during cooking.
- Do not place materials or substances that could melt (plastic or aluminium foil).
- Keep sensor keys clean at all times and do not rest any object on them.
- Do not use cleaning products containing chlorine, ammonia or bleach on steel parts or parts with metallic finishes on the surface (e.g. anodizing, nickel- or chromium-plating).
- Do not use abrasive or corrosive detergents on glass parts (e.g. powder products, stain removers and metallic sponges). Use wooden or plastic utensils.

### 4.2 Cleaning the surfaces

To keep the surfaces in good condition, they should be cleaned regularly after use. Let them cool first.

### 4.3 Ordinary weekly cleaning

Clean and maintain the hob once a week using an ordinary glass cleaning product. Always follow the manufacturer's instructions. The silicon in these products creates a protective, water-repellent membrane which also resists dirt. All marks stay on the membrane and can therefore be removed easily. After cleaning, dry the surface with a clean cloth. Make sure that there is no detergent left on the cooking surface as it will undergo a corrosive reaction when heated up and could modify the structure of the cooking surface.

### 4.4 Food stains or residues

Smudges from aluminium-based pans can be easily cleaned off with a cloth dampened in vinegar.

After cooking, remove any burnt residues; rinse with water and dry thoroughly with a clean cloth.

**Dirt** which may have fallen on the hob while cleaning lettuce or potatoes can scratch the hob when moving pans. Consequently, remove any dirt from the cooking surface immediately.



## Cleaning and maintenance

**Changes in colour** do not affect the operation and stability of the glass. These are not alterations to the material of the hob but just residues which have not been removed and have then carbonised.

**Shiny surfaces** can form due to the bases of pans, especially aluminium ones, rubbing on the surface, and due to the use of unsuitable detergents. They are difficult to remove using conventional cleaning products. It may be necessary to repeat the cleaning process several times. Use of corrosive detergents or rubbing of pan bases can wear away the decoration on the hob over time and contribute to the formation of stains.

### 4.5 What to do if...

The hob does not work:

- Make sure that the hob is connected and that the main switch is turned on.
- Make sure that there is no power failure.
- Make sure that the fuse has not blown. In this case replace the fuse.
- Make sure that the circuit breaker of the residential electrical system has not tripped. In this case, re-activate the circuit breaker.

The cooking results are unsatisfactory:

- Make sure that the cooking temperature is not too high or too low.

The hob smokes:

- Let the hob cool down and clean it once cooking is complete.
- Make sure that the food has not spilled out of the pan and use a larger cooking vessel, if needed.

The fuses blow or the circuit breaker of the residential electrical system trips repeatedly.

- Call Technical Support or an electrician.

There are cracks or fissures in the hob:

- Turn off the appliance immediately, disconnect the power supply and contact Technical Support.





## 5 Installation

### 5.1 Electrical connection



**Power voltage  
Danger of electrocution**

- Have the electrical connection performed by authorised technical personnel.
- Use personal protective equipment.
- The appliance must be connected to earth in compliance with electrical system safety standards.
- Disconnect the mains supply.
- Do not pull the cable to remove the plug.
- Use H05V2V2-F cables withstanding a temperature of at least 90°C.
- The tightening torque of the screws of the terminal supply wires must be 1.5 - 2 Nm.

### General information

Check the grid characteristics against the data indicated on the plate.

The identification plate bearing the technical data, serial number and brand name is visibly positioned on the appliance.

Do not remove this plate for any reason.

Perform the ground connection using a wire that is 20 mm longer than the other wires.

The appliance can work in the following modes:

Hob type (cm)	Connection type	Cable type
30	220-240 V 1N~	3-pole 3 x 1.5 mm <sup>2</sup>
60	220-240 V 1N~ 1 2 3 4 5 ⊕ 	3-pole 3 x 4 mm <sup>2</sup>
	380-415 V 2N~ 1 2 3 4 5 ⊕ 	4-pole 4 x 4 mm <sup>2</sup>

EN

### 60 cm models:

The diagram below illustrates the power supply terminal from below, with no cables connected. Terminals **4** and **5** must be connected at all times.

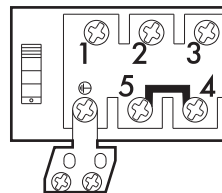



# Installation

## Fixed connection

Fit the power line with an omnipolar circuit breaker in compliance with installation regulations.

The circuit breaker should be located near the appliance and in an easily reachable position.

## Connection with plug and socket

Make sure that the plug and socket are of the same type.

Avoid using adapters and shunts as these could cause overheating and a risk of burns.



Run the power cable in the rear part of the unit. Take care that it does not come into contact with the lower part of the hob or any oven built-in underneath it.



Be careful when connecting additional electrical appliances. Connection cables must not come into contact with hot cooking zones.

## Testing

At the end of installation, carry out a brief inspection test. If the hob fails to operate, after checking that you have carried out the instructions correctly, disconnect the appliance from the mains and contact Technical Support.

## 5.2 Safety instructions



**Heat production during appliance operation**  
**Risk of fire**

- Check that the piece of furniture material is heat resistant.
- Check that the piece of furniture has the required slots.
- Do not obstruct the ventilation grille in front of the product during mounting.

Veneers, adhesives or plastic coatings on adjacent furniture should be temperature-resistant ( $>90^{\circ}\text{C}$ ), otherwise they might warp over time.

The minimum clearance between a ventilation hood and the cooking surface must be at least the distance indicated in the ventilation hood installation instructions.

The minimum clearances must also be respected for the edges of the hob on the back as indicated in the mounting illustrations.



## 5.3 Section cut from the work surface

**i** The following operation requires building and/or carpentry work and must therefore be carried out by a competent tradesman. Installation can be carried out on various materials such as masonry, metal, solid wood or plastic laminated wood as long as they are heat resistant (>90°C).

Create an opening with the dimensions shown in the figure in the work surface of the piece of furniture.

### Mounting dimensions for hob with bevelled edge

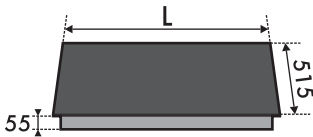

L (mm)	X (mm)	Y (mm)
300	270	490
600	555 - 560	478 - 482

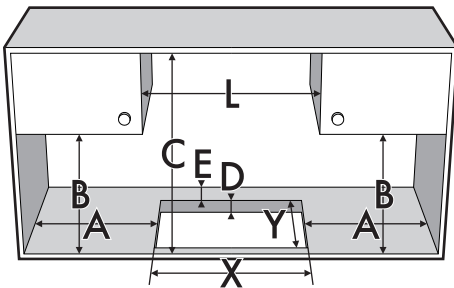

A (mm)	B (mm)	C (mm)	D (mm)	E (mm)
min 50	min 460	min 750	20÷60	min 50

### Mounting dimensions for hob with straight edge

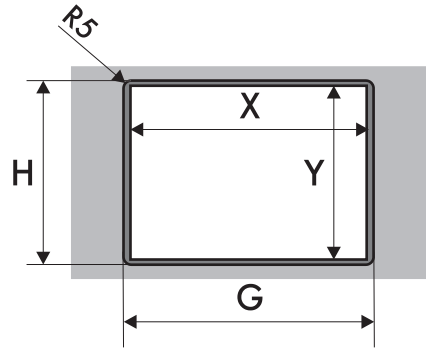

L (mm)	X (mm)	Y (mm)	G (mm)	H (mm)
300	270	490	304	519
600	555 - 560	478 - 482	604	519

After laying the adhesive seal (A) on the glass surface and after positioning and securing the hob, fill the edges with insulating silicone (B) and wipe away any excess.

In the event the hob needs to be removed, cut the silicone using a cutter before attempting to remove it (C).

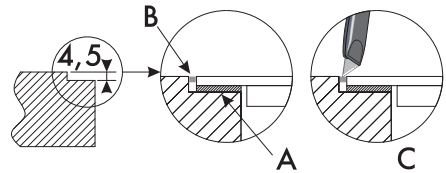

EN



# Installation

## 5.4 Mounting

### Over built-in oven

The clearance between the hob and the kitchen furniture or other installed appliances must be enough to ensure sufficient ventilation and air discharge. If installed above an oven, a space must be left between the bottom of the hob and the top of the appliance installed below.

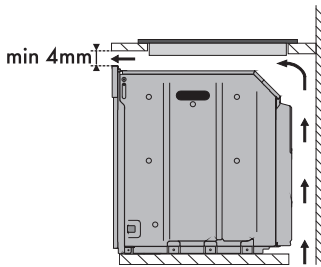

opens on bottom

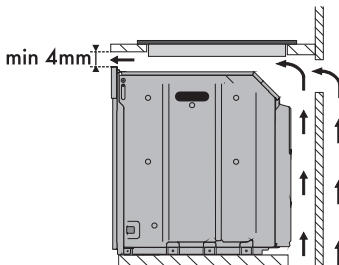

opens on bottom and on rear

### Over empty kitchen unit or drawers

If there are other pieces of furniture (lateral walls, drawers, etc.), dishwashers or fridges under the hob, a double-layer wooden base must be installed at least **20 mm** from the bottom of the hob to avoid any accidental contact. It must only be possible to remove the double-layer base using suitable equipment.

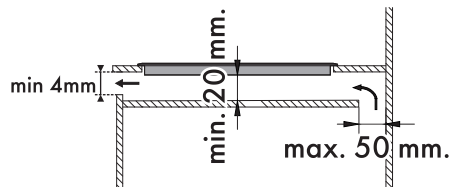
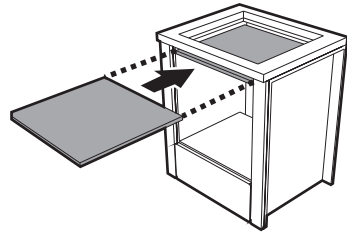

opens on bottom

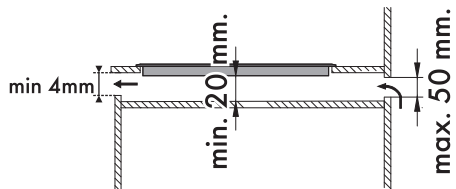

opens on rear



If installed on top of an oven, the latter must be equipped with a cooling fan.



Failure to install the double-layer wooden base exposes the user to possible accidental contact with sharp or hot parts.



## Ventilation

The illustrations below show two examples of installation suitable for proper ventilation and one example of incorrect installation to be avoided.

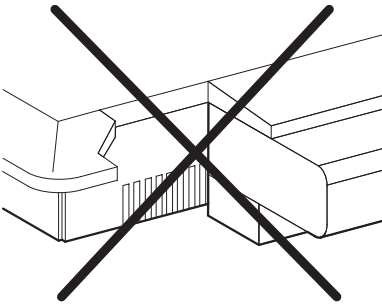
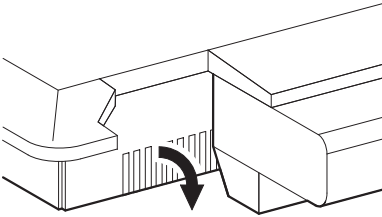
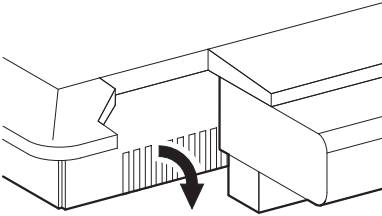

## Hob seal

To prevent leakage of liquid between the frame of the hob and the work surface, place the adhesive seal provided along the entire outer edge of the hob before assembly.

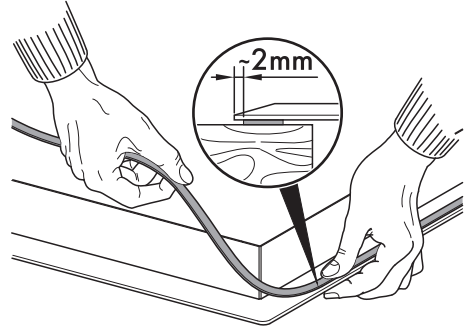

Do not use silicone to secure the hob. This would make it impossible to remove the hob, if necessary, without damaging it.



# Installation

## 5.5 Fixing brackets

Screw the fixing brackets (**A**) into the holes on the sides of the bottom casing to properly fasten the hob to the structure.

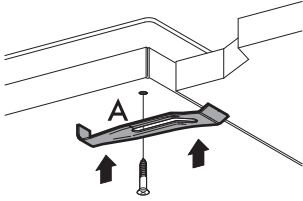

If tightened too much the glass may be strained and crack.