

Contents

1	Instructions	38
1.1	General safety instructions	38
1.2	Instructions for using microwaves	39
1.3	Manufacturer liability	41
1.4	Appliance purpose	41
1.5	Identification plate	41
1.6	Disposal	41
1.7	This user manual	42
1.8	How to read the user manual	42
2	Description	43
2.1	General Description	43
2.2	Control panel	43
2.3	Microwaves	44
2.4	Other parts	44
2.5	Available accessories	45
3	Use	46
3.1	Instructions	46
3.2	First use	47
3.3	Using the accessories	48
3.4	Using the oven	49
3.5	Cooking functions	51
3.6	Special functions	56
3.7	Secondary menu	61
4	Cleaning and maintenance	63
4.1	Instructions	63
4.2	Cleaning the surfaces	63
4.3	Ordinary daily cleaning	63
4.4	Food stains or residues	63
4.5	Drying	64
4.6	Cleaning the door glazing	64
4.7	Cleaning the inside of the oven	64
5	Installation	67
5.1	Electrical connection	67
5.2	Cable replacement	67
5.3	Positioning	68

We advise you to read this manual carefully, which contains all the instructions for maintaining the appliance's aesthetic and functional qualities.

For further information on the product: www.smeg.com



1 Instructions

IMPORTANT SAFETY INSTRUCTIONS PLEASE READ CAREFULLY AND RETAIN FOR FUTURE USE.

1.1 General safety instructions

Risk of personal injury

- **WARNING:** If the door or the door seal is damaged, the oven must not be used until it has been repaired by a competent person.
- **WARNING:** It is hazardous for anyone other than a competent person to carry out any service or repair operation which involves the removal of a cover which offers protection against exposure to microwave energy.
- **WARNING:** Liquids and other foods must not be heated in sealed containers since they are liable to explode.
- **WARNING:** During use the appliance and its accessible parts become very hot.
- Never touch the heating elements during use.
- Keep children under eight years of age at a safe distance if they are not constantly supervised.
- This appliance may be used by children aged at least 8 and by people of reduced physical and mental capacity, or lacking in experience in the use of electrical appliances, as long they are supervised or instructed by adults who are responsible for their safety.
- Children must never play with the appliance.
- The appliance must never be cleaned by unsupervised children.
- Switch off the appliance immediately after use.
- If smoke is emitted, switch off or unplug the appliance and keep the door closed in order to stifle any flames.
- Never attempt to extinguish a flame or fire with water.
- Have qualified personnel carry out installation and assistance interventions according to the standards in force.
- Do not modify this appliance.
- Do not insert pointed metal objects (cutlery or utensils) into the slots in the appliance.



- Do not try to repair the appliance yourself or without the intervention of a qualified technician.
- If the power supply cable is damaged, contact technical support immediately and they will replace it.

Risk of damaging the appliance

- Do not use abrasive or corrosive detergents on glass parts (e.g. powder products, stain removers and metallic sponges).
- Use wooden or plastic utensils.
- Do not use a steam jet to clean the appliance.
- Do not obstruct ventilation openings and heat dispersal slots.
- Never leave the appliance unattended during cooking operations where fats or oils could be released.
- Do not use the appliance to heat rooms for any reason.
- Do not rest any weight or sit on the open door of the appliance.
- Take care that no objects are stuck in the doors.

1.2 Instructions for using microwaves

- Check the appliance visually during the cooking of foods in plastic or paper containers.



Improper use
Danger of explosion



- When using the microwave to heat or reheat liquids, the boiling process may be delayed – boiling temperature can be reached without the formation of the usual "rolling boil". This delayed boiling and consequent superheating of the liquid can generate an explosion inside the appliance, or sudden boiling over of the superheated liquid can occur when removing the container from the appliance. To avoid these dangers, it is necessary to insert the supplied boiling rod (or a heat-resistant plastic spoon) in the container while heating.
- Use the microwave only for the preparation of food for consumption. Other types of applications are strictly forbidden



Instructions

- (e.g. drying clothes, warming slippers, sponges, wet cloths or the like, dehydrating foods) because they can lead to the risk of injury or fire.
- Clean the appliance constantly and remove any food residue.
 - Do not use the microwave to dry food.
 - Do not use the microwave to heat oils or fry.
 - Do not use the appliance to heat foods or beverages containing alcohol.
 - Baby food should not be heated in sealed containers. Remove the cover or the teat (in the case of baby bottles). Always check the preparation's temperature once heating has completed, it should not be too high. For an even temperature and to avoid scalding stir or shake the contents.
 - Do not heat eggs in their shells or whole hard boiled eggs; they may explode even after the heating process has completed.
 - Before cooking food with a hard skin or peel (e.g. potatoes, apples, etc.) it is necessary to puncture the skin.
 - Do not heat food contained within food packages.
 - Do not use the microwave functions when the oven is empty.
 - Use cookware and utensils that are suitable for use in a microwave oven.
 - Do not use aluminium containers to cook food.
 - Do not use dishes with metallic decorations (gold-plated or silver).
 - The appliance operates in the 2.4GHz ISM band.
 - In compliance with the provisions relating to electromagnetic compatibility the appliance belongs to group 2 and class B (EN 55011).
 - This appliance complies with the standards and directives currently in force concerning safety and electromagnetic compatibility. It is however recommended for pacemaker wearers to maintain a minimum distance of 20-30cm between the microwave when it is operating and the pacemaker. Consult the pacemaker manufacturer for more information.



1.3 Manufacturer liability

The manufacturer declines all liability for damage to persons or property caused by:

- Use of the appliance other than the one envisaged;
- Non-observance of the user manual provisions;
- Tampering with any part of the appliance;
- Use of non-original spare parts.

1.4 Appliance purpose

- This appliance is intended for cooking food in the home environment. Every other use is considered inappropriate. It cannot be used:
 - in employee kitchens, shops, offices and other working environments.
 - in farms/agritourism establishments.
 - by guests in hotels, motels and residential environments.
 - in bed and breakfast establishments.
- The appliance is not designed to operate with external timers or with remote-control systems.

1.5 Identification plate

The identification plate bears the technical data, serial number and brand name of the appliance. Do not remove the identification plate for any reason.

1.6 Disposal



This appliance must be disposed of separately from other waste (Directives 2002/95/EC, 2002/96/EC, 2003/108/EC). The appliance does not contain substances in quantities sufficient to be considered hazardous to health and the environment, in accordance with current European directives.



Power voltage

Danger of electrocution

- Disconnect the main power supply.
- Disconnect the power cable from the electrical system.

To dispose of the appliance:

- Cut the power supply cable and remove it along with the plug (if present).
- Deliver the appliance to the appropriate recycling centre for electrical and electronic equipment waste, or return it to the retailer when purchasing an equivalent product, on a one for one basis.



Instructions

Our appliances are packed in non-polluting and recyclable materials.

- Deliver the packing materials to the appropriate recycling centre.



Plastic packaging Danger of suffocation

- Do not leave the packaging or any part of it unattended.
- Do not let children play with the packaging plastic bags.

1.7 This user manual

This user manual is an integral part of the appliance and must therefore be kept in its entirety and within the user's reach for the whole working life of the appliance.

- Read this user manual carefully before using the appliance.

1.8 How to read the user manual

This user manual uses the following reading conventions:

Instructions



General information on this user manual, on safety and final disposal.

Description



Description of the appliance and its accessories.

Use



Information on the use of the appliance and its accessories, cooking advice.

Cleaning and maintenance



Information for proper cleaning and maintenance of the appliance.

Installation



Information for the qualified technician: Installation, operation and inspection.



Safety instructions



Information



Advice

1. Use instruction sequence.

- Single use instruction.



2 Description

2.1 General Description

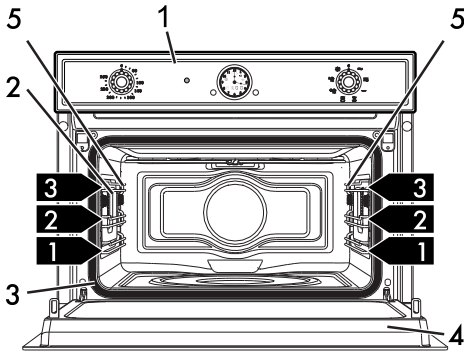

- 1 Control panel
- 2 Oven light
- 3 Seal

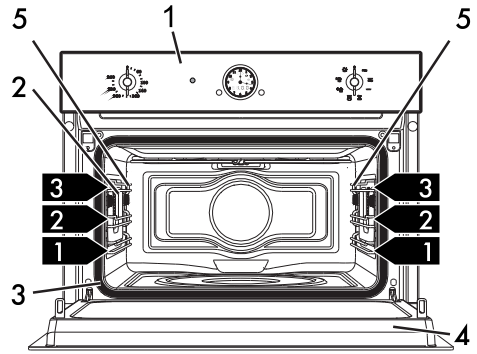

- 4 Door
- 5 Rack/tray support frames
- 1,2,3... Frame shelf

2.2 Control panel

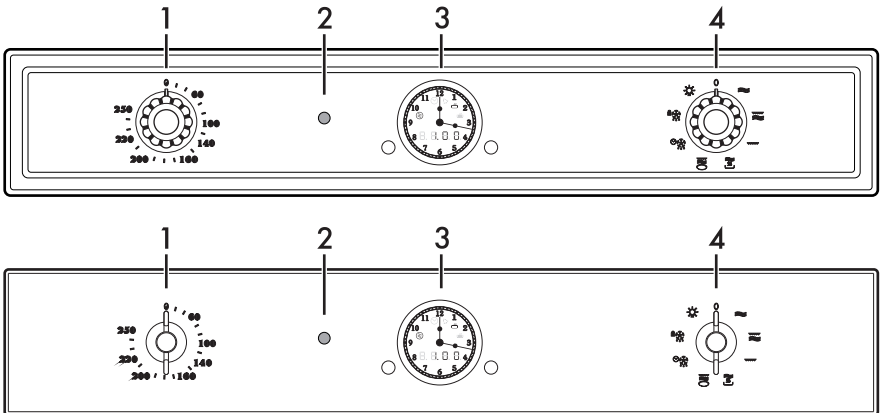

1 Temperature knob

This knob allows you to select the cooking temperature when using a traditional or combination function.

EN



Description

2 Thermostat indicator light

Traditional and combination functions: when the indicator light is flashing, it indicates that the oven is heating up to reach the set temperature. Once the temperature has been reached, the light remains lit until the oven is switched off.

Microwave functions: remains lit to indicate that a microwave function is in progress. Always remains lit until the oven is turned off.

3 Clock

Displays the current time, the selected cooking temperature and power, and any time set.

4 Function knob

This knob can be used to:

- Turn the appliance on and off
- Select a function
- Turn the appliance's internal lighting on or off



When you have finished using the appliance, always return the function knob to the **0** position.

2.3 Microwaves

The appliance is equipped with a microwave generator called a magnetron. The microwaves generated are evenly emitted into the oven compartment in order to reach the food and heat it.

Heating takes place through the process of friction between the molecules contained within the food (mainly water molecules), with the consequent generation of heat.

The heat generated directly inside the food leads to defrosting, re-heating or cooking in a shorter length of time compared to traditional cooking.

The use of suitable containers for microwave cooking allows the microwaves to reach the food in a uniform manner (see Materials suitable for microwaves).

2.4 Other parts

Shelves

The appliance features shelves to position trays and racks at different heights. The insertion heights are indicated from the bottom upwards (see 2.1 General Description).

Cooling fan

The fan cools the oven and comes into operation during cooking.

The fan causes a steady outflow of air from above the door which may continue for a brief period of time even after the appliance has been turned off.



Interior lighting

The appliance's interior lighting comes on:

- When the door is opened
- When any function is selected
- When the function knob is turned to the

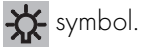

symbol.

2.5 Available accessories



Some models are not provided with all accessories.

Rack

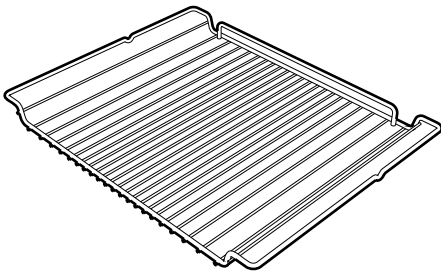

Useful for supporting containers with food during cooking.

Baker Plate

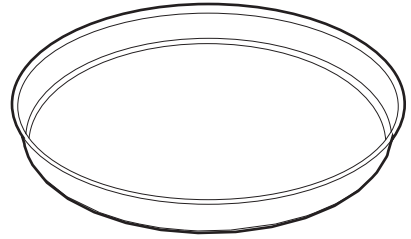

Good for browning foods evenly.

Boiling rod



To be placed in containers when heating liquids, necessary to avoid delayed boiling with resulting superheating.



The oven accessories intended to come into contact with food are made of materials that comply with the provisions of current legislation.



Original supplied and optional accessories can be requested to Authorised Assistance Centres. Use only original accessories supplied by the manufacturer.



3 Use

3.1 Instructions



High temperature inside the oven during use

Danger of burns

- Keep the oven door closed during cooking.
- Protect your hands wearing heat resistant gloves when moving food inside the oven.
- Do not touch the heating elements inside the oven.
- Do not pour water directly onto very hot trays.
- Do not allow children to get near the oven when it is in operation.



High temperature inside the oven during use

Danger of fire or explosion

- Do not spray any spray products near the oven.
- Do not use or leave flammable materials near the oven.
- Do not use plastic kitchenware to cook food (except with the microwave function).
- Do not put sealed tins or containers in the oven.
- Do not leave the oven unattended during cooking operations where fats or oils could be released.
- Remove all trays and racks which are not required during cooking.



Improper use

Risk of damage to enamelled surfaces

- Do not cover the bottom of the oven cavity with aluminium or tin foil sheets.
- If you wish to use greaseproof paper, place it so that it will not interfere with the hot air circulation inside the oven.
- Do not bang or drag cookware over the glazed bottom of the oven compartment.
- Do not pour water directly onto very hot trays.

Materials suitable for microwaves

In general, in order for the food to be reached, the materials used for microwave cooking must be transparent to microwave energy.

Materials suitable for use:

- **Glass*** (always remove covers): oven dishes, glasses, glass jars.
- **Porcelain.**
- **Ceramics/Terracotta.**
- **Plastic*** (microwave safe): containers, cling film (must not come into contact with the food during cooking).

*only if heat-resistant.



Materials which must not be used :

- **Metal** (generates sparks/arcing): aluminium foil and trays, metal dishes and utensils, freezer bag twist ties.
- **Wood.**
- **Crystal glasses.**
- **Paper** (risk of fire).
- **Expanded polystyrene containers** (possible contamination of foodstuffs).

Testing dishes



The microwave function can be used without any food inside the oven only for this test.

To check whether or not cookware is suitable for use with microwave cooking carry out this simple test:

1. Remove all accessories from the oven cavity.
2. Place the cookware to be tested on the rack inserted in the first runner.
3. Select the maximum power level (e.g. 1000W).
4. Set a cooking time of 30 seconds.
5. Start cooking.



Unsuitable cookware
Risk of damage to the appliance

- If there is crackling or if sparks are emitted from the cookware then immediately terminate the test. In this instance the cookware is not suitable for microwave cooking.

6. At the end of the test the cookware must be either cold or slightly warm. If the cookware is hot then it should be considered as unsuitable for microwave use.

3.2 First use

1. Remove any protective film from the outside or inside of the appliance, including accessories.
2. Remove any labels (apart from the technical data plate) from the accessories and from the oven cavity.
3. Remove and wash all the appliance accessories (see 4 Cleaning and maintenance).
4. Heat the empty oven at maximum temperature (using the traditional functions) so as to remove any manufacturing residues.



For the first reheating use a traditional function and not a microwave function.



Use

3.3 Using the accessories

Rack

The rack must be inserted into the side guides until it comes to a complete stop.

- The mechanical safety locks that prevent the rack from being taken out accidentally have to face downwards and towards the oven back.

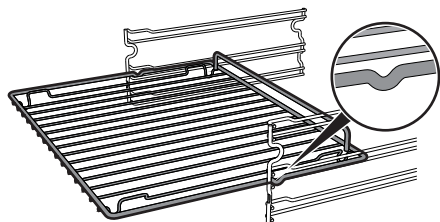

High temperature
Danger of burns

- This accessory gets very hot. Always use oven gloves when handling.



Insert the rack delicately into the oven until it stops.



Clean the rack before using it for the first time to remove any residue left by the manufacturing process.

Baker plate

For optimum performance, the Baker Plate must be placed in the centre of the rack.

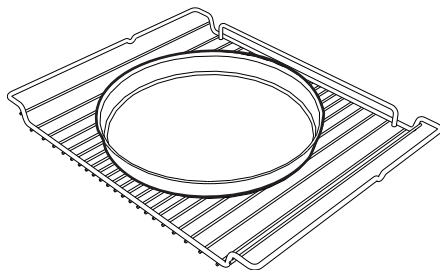

High temperature
Danger of burns

- The accessory gets very hot. Always use oven gloves when handling.



Improper use
Risk of damage to surfaces

- Do not use knives directly on the surface of the plate
- When cleaning, do not use metal sponges or scourers which could damage the surface.



Boiling rod

When using the microwave to heat or warm liquids there may be a delay during the boiling process. To avoid this phenomenon, it is necessary to insert the supplied boiling rod (or a heat-resistant plastic spoon) in the container while reheating.



Improper use Danger of explosion/burns

- To avoid the danger of explosion inside the appliance or the sudden boiling over of superheated liquids, it is always necessary to immerse the boiling rod in the liquid being heated.



High temperature Risk of damage to the accessory

- Use the boiling rod only with Microwave functions. The rod must not be used with combined and traditional functions.

3.4 Using the oven

Clock

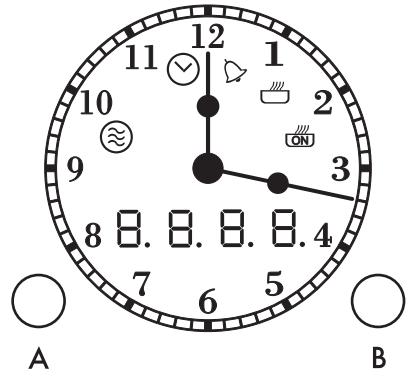

Microwave indicator light



Clock indicator light



Minute minder timer indicator light



Timed cooking indicator light



Programmed cooking indicator light

A Setting knob

B Confirmation knob



Use

Operating modes

Stand-by: When no function is selected, the clock shows the current time.

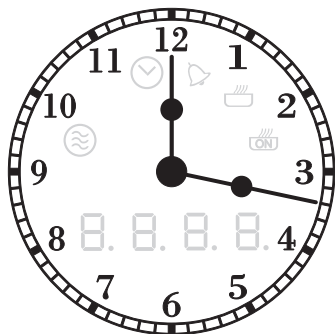

ON: The function knob must be turned away from the **0** position to start any function. The clock shows the set parameters, such as temperature, cooking time, microwave power and when the set temperature has been reached.

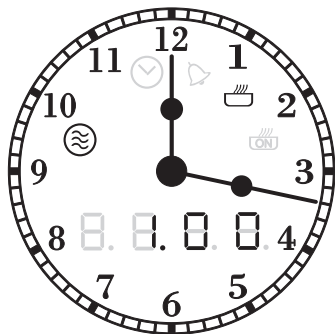

Setting the time

On first use, or after a power failure, the  symbol flashes on the clock.

1. Turn the setting knob to the left or right to set the current time.
2. After approximately 5 seconds, the  symbol will disappear and the clock will resume regular operation.

It may become necessary to change the current time, for example for daylight saving time.

3. To change the clock setting, ensure that no function is active (the **temperature knob** and **function knob** must be in the **0** position).
4. Turn the setting knob to the left or right.



3.5 Cooking functions



Improper use Risk of damage to the appliance

When using the microwave functions, food must be placed in a suitable container on the rack inserted in the first runner.

DO NOT USE CONTAINERS/
ACCESSORIES (trays, glass dishes, etc.)
PLACED DIRECTLY ON THE FLOOR OF
THE OVEN.

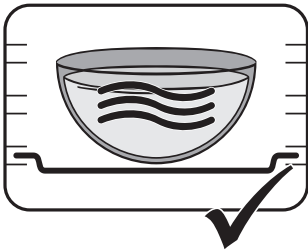
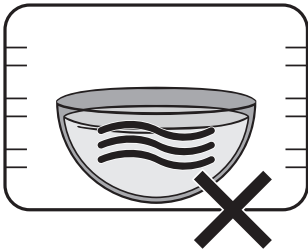

For best results, with prolonged microwave and combined cooking, it is best to stir foods once or twice.







Cooking functions can be interrupted at any time by turning the function knob to the **0** position.

Microwaves





Given that they penetrate directly into the food, microwaves allow cooking to take place in a very short period of time and with a considerable saving of energy. They are suitable for cooking without fat and also for defrosting and re-heating food while maintaining its original appearance and fragrance.

1. Turn the function knob to the **microwave** symbol. The  and  symbols flash on the clock and the display shows the default cooking time  (minutes/seconds).
2. Turn the setting knob to the left or right to set the cooking time value (max 30 minutes).
3. Press the setting knob. The  symbol flashes on the clock and the display shows the default microwave power .
4. Turn the setting knob to the left or right to modify the power value from 100W to 1000W (see "Microwave power levels").



Use

- Press the setting knob to confirm the set data. The  and  symbols flash on the clock.
- Press the confirmation knob to start cooking.



If the door is opened then cooking will stop. After closing it again, press the confirmation knob to continue cooking.



Press the confirmation knob to temporarily stop the cooking function. Press it again to resume cooking.

- At the end of the cooking time, **STOP** will flash on the display and a buzzer will sound that can be deactivated by pressing the setting knob.



Turn the setting knob to set an additional cooking time. Press the confirmation knob to start cooking.



To switch the appliance off, turn the **function knob** to the **0** position.



It is not possible to set a microwave cooking function without setting a cooking time.

Microwave power levels

Below is a list of the power levels that can be selected:







Power (W)	Useful for
100	Defrosting food
200	
300	
400	Cooking meat or delicate cooking
500	
600	Re-heating and cooking food
700	
800	
900	Heating liquids
1000	



Combination (microwave + grill)



The use of the grill results in perfect browning of the food's surface. Using the microwave on the other hand leads to rapid internal cooking of the food.

1. Turn the function knob to the **combination** symbol. The  and  symbols flash on the clock and the display shows the default cooking time  (hours/minutes).
2. Turn the setting knob to the left or right to set the cooking time value (max 13 hours).
3. Press the setting knob. The  symbol flashes on the clock and the display shows the default microwave power .
4. Turn the setting knob to the left or right to modify the power value from 100W to 700W.
5. Press the setting knob to confirm the set data. The  and  symbols flash on the clock.
6. Turn the temperature knob to set the required temperature. The set temperature will be displayed for 5 seconds.
7. Press the confirmation knob to start cooking.



If the door is opened then cooking will stop. After closing it again, press the confirmation knob to continue cooking.



During cooking it is possible to modify the cooking temperature. Turn the temperature knob to set the new temperature, which is shown on the display for 5 seconds.



Press the confirmation knob to temporarily stop the cooking function. Press it again to resume cooking.

8. At the end of the cooking time,  will flash on the display and a buzzer will sound that can be deactivated by pressing the setting knob.



Turn the setting knob to set an additional cooking time. Press the confirmation knob to start cooking.



To switch the appliance off, turn the **function knob** to the **0** position.



Preheating is not performed with this function.



Traditional (grill)

The heat coming from the grill element gives perfect grilling results above all for thin and medium thickness meat and allows you to give the food an even browning at the end of the cooking. Perfect for sausages, spare ribs and bacon. This function enables large quantities of food, particularly meat, to be grilled evenly.

1. Turn the function knob to the **grill** symbol.
2. Turn the temperature knob to the required value (from 50° to 250°). The display will show the set temperature (e.g.





).

3. After a few seconds, the thermostat light will flash to indicate that preheating has begun.
4. Once the temperature has been reached, the thermostat light will stop flashing and a buzzer will sound to indicate that the food can now be placed in the oven.
5. When cooking has finished, turn the function and temperature knobs to the **0** position.

Timed cooking

 Timed cooking is the function which allows a cooking operation to be started and then ended after a specific length of time set by the user.

After setting a traditional cooking function:

1. Press the setting knob twice. The  symbol flashes on the clock and the display shows the default cooking time  (hours/minutes).
2. Turn the setting knob to the left or right within 5 seconds to set the cooking time value (max 13 hours).
3. Press the setting knob twice (the  and  symbols will flash on the clock), or wait 5 seconds from the last setting: the  symbol will stay lit and timed cooking has begun.

While timed cooking is in progress, it is possible to further modify its duration.

4. Press the setting knob.
5. Turn the setting knob to the left or right within 5 seconds to set the new cooking time value.



- Press the setting knob twice or wait 5 seconds from the last setting.
- At the end of the cooking time, **STOP** will flash on the display and a buzzer will sound that can be deactivated by pressing the setting knob.



To delete timed cooking at any moment, press the setting knob and hold for approximately 3 seconds.

Delayed cooking



Delayed cooking is the function which allows cooking to be started after a length of time set by the user, after which the oven will switch off automatically.

After setting a traditional cooking function:

- Press the setting knob twice. The  symbol flashes on the clock and the display shows the default cooking time **00.00** (hours/minutes).
- Turn the setting knob to the left or right within 5 seconds to set the cooking time value (max 13 hours). E.g. **01.00**

- Press the setting knob. The  symbol flashes on the clock and the display shows the default delay time **00.00** (hours/minutes).
- Turn the setting knob to the left or right within 5 seconds to set the cooking time value (max 24 hours). E.g. **00.30**
- Press the setting knob or wait 5 seconds from the last setting: delayed cooking has begun.
- The set delay time is shown on the display (in our example **00.30**).
- After this length of time has passed, cooking will start and the display will show the cooking time (in our example **01.00**).
- At the end of the cooking time, **STOP** will flash on the display and a buzzer will sound that can be deactivated by pressing the setting knob.



To delete delayed cooking at any moment, press the setting knob and hold for approximately 3 seconds.



Use



Minute minder



This function only activates the buzzer, without stopping cooking.





The minute minder can be activated both during cooking and when the appliance is in standby.

1. Press the setting knob. The  symbol flashes on the clock and the display shows the default cooking time  (hours/minutes).
2. Turn the setting knob to the left or right within 5 seconds to set the cooking time value (max 4 hours).
3. Press the setting knob once again or wait 5 seconds from the last setting entered: the  symbol stays lit and the minute minder has started.

While the minute minder is in progress, it is possible to further modify its duration.

4. Press the setting knob.
5. Turn the setting knob to the left or right within 5 seconds to set the new cooking time value.
6. Press the setting knob again or wait 5 seconds from the last setting.

7. At the end of the minute minder,  and the  symbol will flash and a buzzer will sound that can be deactivated by pressing the setting knob.







To delete a minute minder at any moment, press the setting knob and hold for approximately 3 seconds.

3.6 Special functions

Reheating



This function is for microwave reheating of food that has been previously cooked and stored in the refrigerator.

1. Turn the function knob to the **reheating** symbol. The  and  symbols flash on the clock and the display shows the default cooking time  (minutes/seconds).
2. Turn the setting knob to the left or right to set the cooking time value (max 99 minutes).
3. Press the setting knob.
4. Press the confirmation knob to start reheating.
5. At the end of the reheating time,  will flash on the display and a buzzer will sound that can be deactivated by pressing the setting knob.







Baker

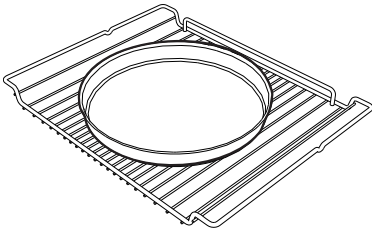

This function provides food with a golden, crunchy texture by using the Baker plate. Ideal for pizzas, oven chips and pies.

1. Position the rack on the required level. Place the empty Baker plate in the centre.



2. Turn the function knob to the **baker** symbol. The  and  symbols flash on the clock and the display shows the default cooking time  (minutes/seconds).
3. Turn the setting knob to the left or right to set the cooking time value (max 99 minutes).
4. Press the setting knob. The  symbol flashes on the clock.
5. Press the setting knob to confirm the set data.

6. Press the confirmation knob to start the baker function. After a few seconds, the thermostat light will flash to indicate that preheating has begun.
7. Once the temperature has been reached,  will appear on the display, the thermostat light will stop flashing and a buzzer will sound to indicate that the food can now be placed in the oven.



**High temperature
Danger of burns**

- Use oven gloves when handling the Baker plate

8. Position the food inside the Baker plate.

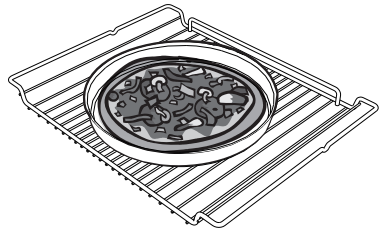

**Improper use
Risk of damage to the appliance**

- Do not position recipients on the Baker plate if they are not heat proof.



Use

- Press the confirmation knob to resume cooking.
- At the end of the baker function, **STOP** will flash on the display and a buzzer will sound that can be deactivated by pressing the setting knob.

Cooking suggestions table

Type	Weight (g)	Shelf	Time (min)
Frozen pizza	300	2	11
Fresh pizza	600	2	14
Frozen oven chips	500	2	15
Frozen chicken nuggets	500	2	16
Fresh beaten eggs	400	2	9



The indicated time includes the time for preheating the empty Baker plate.

Defrost by time



This function allows food to be defrosted by the microwave according to a selected period of time.

- Place the dish into the oven compartment (see "Turn" procedure).
- Turn the function knob to the **Defrost by time** symbol. The and symbols flash on the clock and the display shows the default cooking time **00:00** (minutes/seconds).
- Turn the setting knob to the left or right to set the cooking time value (max 99 minutes).
- Press the setting knob.
- Press the confirmation knob to start reheating.



If the door is opened then defrosting will stop. After closing it again, press the confirmation knob to continue defrosting.



Press the confirmation knob to temporarily stop the defrosting function. Press it again to resume defrosting.

- At the end of the defrosting, **STOP** will flash on the display and a buzzer will sound that can be deactivated by pressing the setting knob.



Turn the setting knob to set an additional cooking time.
Press the confirmation knob to start cooking.



If the selected defrost duration is more than 5 minutes then, for best results, the dish inside the oven compartment will need to be turned. See: "Turn" procedure.

Defrost by weight



This function allows food to be microwave defrosted according to the weight and type of food to be defrosted.

1. Place the dish into the oven compartment (see "Turn" procedure).
2. Turn the function knob to the **Defrost by weight** symbol. The default text **d01** will appear on the display to indicate the first available defrosting function.
3. Turn the setting knob to the left or right to select the required program (**d01** - **d04**).
4. Press the setting knob. The default weight in grams **500** will appear on the display (if program **d01** is selected).

5. Turn the setting knob to the left or right to set the weight of the food to defrost.
6. Press the setting knob to confirm the set data.
7. Press the confirmation knob to start the defrosting function.
8. At the end of the defrosting, **STOP** will flash on the display and a buzzer will sound that can be deactivated by pressing the setting knob.



If the selected defrost duration is more than 5 minutes then, for best results, the dish inside the oven compartment will need to be turned. See: "Turn" procedure.

Pre-set parameters

Type	Weight (g)	Time (min)
d01: Meat	500 (min 100 max 1100)	20
d02: Fish	400 (min 100 max 700)	17
d03: Fruit	300 (min 100 max 500)	15
d04: Bread	300 (min 100 max 500)	5



Use

“Turn” procedure

For best defrosting results it is recommended, when necessary, to turn the dish inside the oven compartment.

1. Put the dish in the oven placing it parallel to the door.

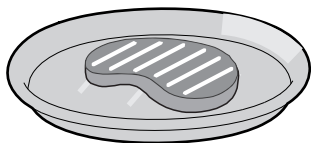

2. When **TURN** is displayed it is necessary to turn the dish.

3. Open the door and turn the dish 90°.

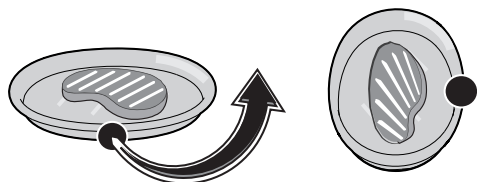

5. If necessary the appliance will again ask for rotation of the dish. The text **TURN** will appear on the display.
6. For the second rotation the door will need to be opened and the dish turned by 180°.

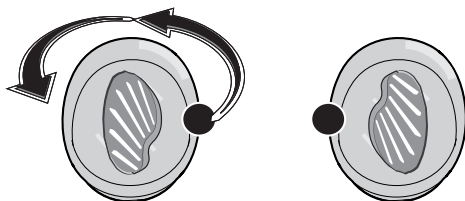

7. Close the door and press the confirmation knob to resume the function.

Light



This function allows you to turn on the light inside the appliance when no function is active.

1. Turn the function knob to the **light** symbol.
2. When you have finished, always return the function knob to the **0** position.



If dish rotation is not performed the appliance will wait for one minute and then automatically continue defrosting.

As a reminder, **TURN** will still remain on the display.

4. Close the appliance door and press the confirmation knob to resume the function.



3.7 Secondary menu

The appliance also has a drop-down secondary menu allowing the user to:

- Activate or deactivate the Child Lock.
- Activate or deactivate Showroom mode (which disables all the heating elements so that only the control panel works).
- Activate or deactivate Low Power mode (Eco-Logic).
- Activate or deactivate Keep warm mode.

With the appliance in Stand-By (temperature and functions knobs to **0**):

1. Press and hold the setting knob and confirmation knob together for 5 seconds.
2. Turn the setting knob to the left or right to change the setting (**ON/OFF**).
3. Press the setting knob to move to the next mode.

P1: Child Lock

This mode allows the appliance to lock the controls automatically after one minute of normal operation without any intervention from the user.

P 1.0F

P 1.0n

One minute after the last setting the lock will become active again.

To temporarily release the lock during cooking, hold the setting knob down for 5 seconds. One minute after the last setting the lock will become active again.



Touching or varying the position of the temperature and function knobs will make the display show

6EaC

for two seconds.



Even with the child lock mode activated, the appliance can be turned off instantly by turning the function knob to the **0** position.



Use

P2: Show Room (for shops only)

This mode allows the appliance to deactivate all heating elements, while keeping the control panel active.

P2.OF

P2.ON

To use the appliance normally, set this mode to OFF.

P4: Keep Warm

In this mode, at the conclusion of the cooking cycle for which a duration was set (if not stopped manually), the appliance keeps freshly cooked food warm (at low temperatures) for around 1 hour.

P4.OF

P4.ON



If the mode is active, **SHO** will appear on the display once a minute for 3 seconds.



If this mode is active, **Hold** will appear on the display at the end of traditional cooking.

P3: Low Power (Eco-Logic)

This mode allows the appliance to limit the power used.

Suitable for simultaneous use with further home appliances.

P3.HI

P3.LO

HI: normal power.

LO: low power.



Activating low power mode means that preheating and cooking times may be extended.



4 Cleaning and maintenance

4.1 Instructions



Improper use
Risk of damage to surfaces

- Do not use a steam jet to clean the appliance.
- Do not use cleaning products containing chlorine, ammonia or bleach on steel parts or parts with metallic finishes on the surface (e.g. anodizing, nickel- or chromium-plating).
- Do not use abrasive or corrosive detergents on glass parts (e.g. powder products, stain removers and metallic sponges).
- Do not use rough or abrasive materials or sharp metal scrapers.
- Failure to clean the oven could adversely affect the life of the appliance and pose a hazard.
- Always remove food residues from the oven compartment.



If a lamp is damaged contact Technical support for a replacement. This fault will not affect the integrity of the appliance which can continue to be used.



High temperatures inside the oven after use

Danger of burns

- Perform cleaning only after letting the appliance cool down.

4.2 Cleaning the surfaces

To keep the surfaces in good condition, they should be cleaned regularly after use. Let them cool first.

4.3 Ordinary daily cleaning

Always use only specific products that do not contain abrasives or chlorine-based acids.

Pour the product onto a damp cloth and wipe the surface, rinse thoroughly and dry with a soft cloth or a microfibre cloth.

4.4 Food stains or residues

Do not use metallic sponges or sharp scrapers as they will damage the surfaces.

Use ordinary non-abrasive products with the aid of wooden or plastic utensils if necessary. Rinse thoroughly and dry with a soft cloth or a microfibre cloth.

Do not allow residues of sugary foods (such as jam) to set inside the oven. If left to set for too long, they might damage the enamel lining of the oven.



Cleaning and maintenance

4.5 Drying

Cooking food raises the humidity inside the cooking compartment. This is a perfectly normal phenomenon that does not compromise the correct operation of the appliance.

At the end of each cooking session:

1. Allow the appliance to cool down
2. Wipe down the cooking compartment
3. Dry the cooking compartment with a soft cloth
4. Leave the door open as long as necessary to ensure that the cooking compartment dries completely.

4.6 Cleaning the door glazing

The glass in the door should always be kept thoroughly clean. Use absorbent kitchen roll. In case of stubborn dirt, wash with a damp sponge and an ordinary detergent.



We recommend the use of cleaning products distributed by the manufacturer.

4.7 Cleaning the inside of the oven

For the best oven upkeep, clean it regularly after having allowed it to cool.

Take out all removable parts.

Clean the oven racks with warm water and non-abrasive detergent. Carefully rinse and dry damp parts.

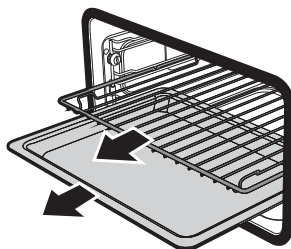

The oven should be operated at the maximum temperature for about 15-20 minutes after the use of specific products, to burn off the residues left inside the oven.



Removing racks/trays support frames

Removing the guide frames enables the sides to be cleaned more easily. This operation should be performed each time the automatic cleaning cycle is used (on some models only).

To remove the guide frames:

1. Unscrew the two fastening pins of the frame.

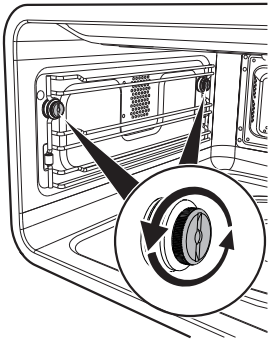

2. Pull the frame towards the inside of the oven.

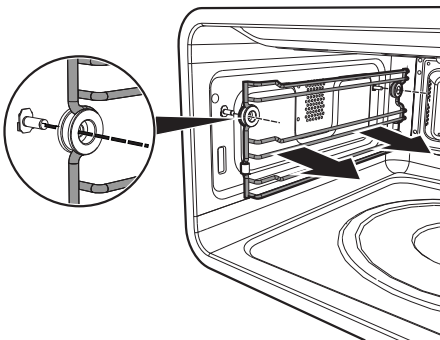

3. When cleaning is complete, repeat the above procedures to put the guide frames back in. Pay attention to the spacer bushings which need to be inserted correctly into the frames.

Cleaning the top of the compartment

The appliance is equipped with a tilting grill element that allows for easy cleaning of the upper part of the oven compartment.

1. Free the upper heating element by gently lifting it and rotating its retaining latch by 90 degrees.

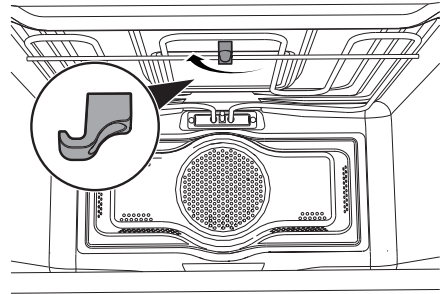

2. Gently lower the heating element until it stops.

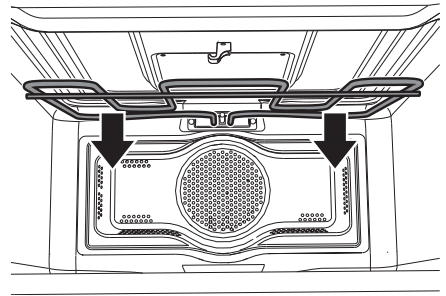

Improper use

Risk of damage to the appliance

- Do not excessively flex the element during cleaning.

3. When you have finished cleaning, place the heating element back in position and turn the retaining latch to lock it in place.



Cleaning and maintenance

What to do if...

The display is completely off:

- Check the mains power supply.
- Check that any circuit breaker/switch upline of the appliance power supply connection is in the "ON" position.

The appliance does not heat up:

- Check whether it has been set in "showroom" mode (for further details see "P2: Show Room (for shops only)").

The controls do not respond:

- Check whether it has been set in "child lock" mode (for further details see "P1: Child Lock").

The cooking times are longer than those indicated in the table:

- Check whether it has been set in "low power" mode (for further details see "P3: Low Power (Eco-Logic)").



If the problem has not been resolved or in the case of other types of fault, contact your local technical support centre.



If other ERRx error messages are indicated:

Note down the error message, function and set temperature and contact your local technical support centre.



5 Installation

5.1 Electrical connection



Power voltage
Danger of electrocution

- Have the electrical connection performed by authorised technical personnel.
- The appliance must be connected to earth in compliance with electrical system safety standards.
- Disconnect the main power supply.

General information

Check the grid characteristics against the data indicated on the plate.
The identification plate bearing the technical data, serial number and brand name is visibly positioned on the appliance.
Do not remove this plate for any reason.
The appliance works at 220-240 V~.
Use a H05V2V2-F type three-core cable (3 x 1.5 mm² cable, referring to the cross section of the internal conductor).
Perform the ground connection using a wire that is 20 mm longer than the other wires.

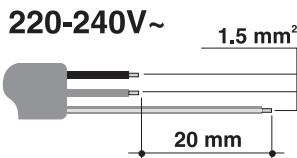

Fixed connection

Fit the power line with an omnipolar circuit breaker in compliance with installation regulations.

The circuit breaker should be located near the appliance and in an easily reachable position.

Connection with plug and socket

Make sure that the plug and socket are of the same type.

Avoid using adapters and shunts as these could cause overheating and a risk of burns.

5.2 Cable replacement



Power voltage
Danger of electrocution

- Disconnect the main power supply.

1. Unscrew the rear casing screws and remove the casing to access the terminal board.
2. Replace the cable.
3. Make sure that the cables (for the oven or any hob) follow the best route in order to avoid any contact with the appliance.



Installation

5.3 Positioning



**Heavy appliance
Danger of crush injuries**

- Place the appliance into the piece of furniture with the aid of a second person.



**Pressure on the open door
Risk of damage to the appliance**

- Never use the oven door to lever the appliance into place when fitting.
- Avoid exerting too much pressure on the oven door when open.



**Heat production during appliance operation
Risk of fire**

- Check that the piece of furniture material is heat resistant.
- Check that the piece of furniture has the required slots.
- Do not install the appliance in a recess which can be closed with a door, or in a cupboard.

Secure the appliance to the piece of furniture using screws.

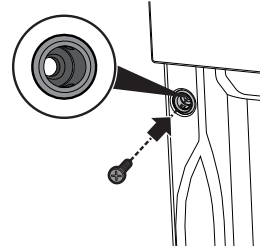

Cover the bushings with the covers removed previously.

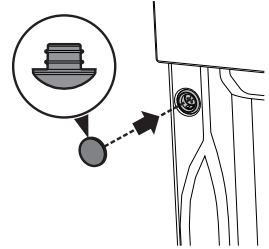

Appliance overall dimensions (mm)

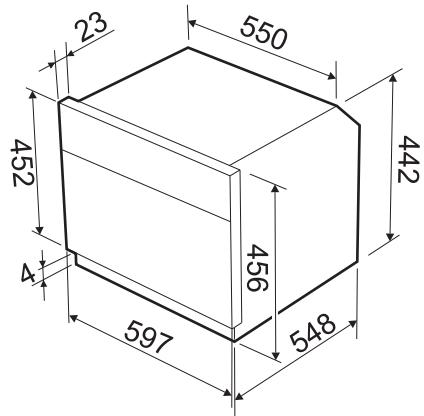

Fastening bushings

Remove the bushing covers inserted on the oven front.
Mount the appliance into the recess.

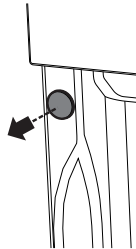

Installation



Mounting under worktops (mm)

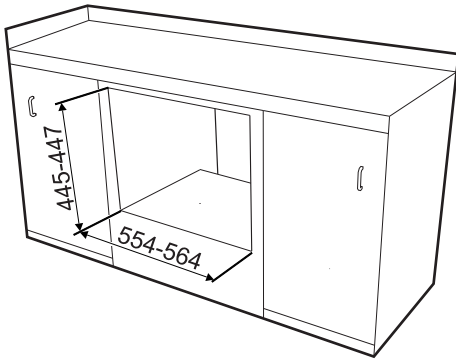

Mounting into a column (mm)

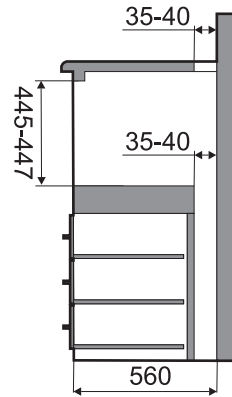
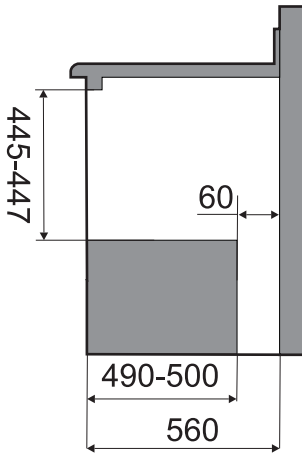
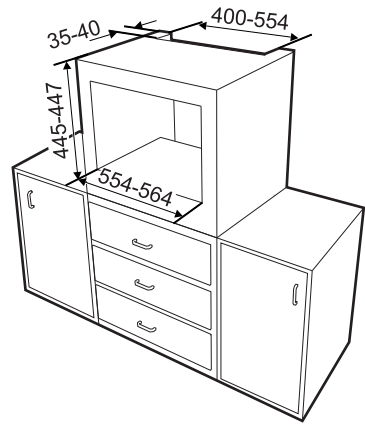

Make sure that the piece of furniture rear/bottom part has an opening of approx. 60 mm.



Make sure that the piece of furniture top/rear part has an opening approx. 35-40 mm deep.

