

Contents

1 Instructions	54
1.1 General safety instructions	54
1.2 Appliance purpose	58
1.3 Manufacturer liability	58
1.4 This user manual	58
1.5 Identification plate	58
1.6 Disposal	59
1.7 How to read the user manual	60
2 Description	61
2.1 General Description	61
2.2 Symbols	64
2.3 Available accessories	65
3 Use	66
3.1 Instructions	66
3.2 Precautions	67
3.3 First use	67
3.4 Using the gas burners	68
3.5 Using the induction hot plates	70
3.6 Practical advice	82
4 Cleaning and maintenance	83
4.1 Instructions	83
4.2 Cleaning the appliance	83
4.3 What to do if...	85
5 Installation	86
5.1 Safety instructions	86
5.2 Section cut from the countertop	86
5.3 Mounting	88
5.4 Gas connection	90
5.5 Adaptation to different types of gas	93
5.6 Electrical connection	100
5.7 Instructions for the installer	102

TRANSLATION OF THE ORIGINAL INSTRUCTIONS

These instructions apply only for the destination countries listed on the appliance's data plate.
This is a class 3 built-in hob.

We advise you to read this manual carefully, which contains all the instructions for maintaining the appliance's aesthetic and functional qualities.

For further information on the product: www.smeg.com



1 Instructions

1.1 General safety instructions

Risk of personal injury

- During use the appliance and its accessible parts become very hot. Never touch the heating elements during use.
- Protect your hands by wearing oven gloves when moving food inside the oven.
- Never try to put out a fire or flames with water: Turn off the appliance and smother the flames with a fire blanket or other appropriate cover.
- This appliance may be used by children aged at least 8 and by people of reduced physical, sensory or mental capacity, or lacking in experience in the use of electrical appliances, provided that they are supervised or instructed by adults who are responsible for their safety.
- Children must not play with the appliance.
- Keep children under the age of 8 at a safe distance unless they are constantly supervised.
- Keep children under the age of 8 away from the appliance when it is in use.
- Cleaning and maintenance must not be carried out by unsupervised children.
- Make sure that the flame-spreader crowns are correctly positioned in their housings with their respective burner caps.
- Be aware of how rapidly the cooking zones heat up. Do not place empty pans on the heat. Danger of overheating.
- Fats and oils can catch fire if they overheat. Do not leave the appliance unattended while preparing foods containing oils or fats. If fats or oils catch fire, never put water on them. Place the lid on the pan and turn off the relevant cooking zone.



- The cooking process must always be monitored. A short cooking process must be continuously monitored.
- Do not place metal objects, such as dishes or cutlery, on the hob surface during use as they may overheat.
- Do not insert pointed metal objects (cutlery or utensils) into the slots in the appliance.
- Do not pour water directly onto very hot trays.
- Do not use aerosols in the vicinity of this appliance whilst it is in use.
- Switch off the appliance immediately after use.
- Do not modify this appliance.
- Do not try to repair the appliance yourself or without the intervention of a qualified technician.
- Do not pull the cable to remove the plug.
- If the power supply cable is damaged, contact technical support immediately and they will replace it.

Risk of damaging the appliance

- Do not use abrasive or corrosive detergents (e.g. scouring powders, stain removers and metallic sponges) on glass parts.
- Use wooden or plastic utensils.
- Do not seat on the appliance.
- Do not use steam jets to clean the appliance.
- Do not obstruct ventilation openings and heat dispersal slots.
- Never leave the appliance unattended during cooking operations where fats or oils could be released, as these could then heat up and catch fire. Be very careful.
- Never leave objects on the cooking surface.
- Do not use the appliance to heat rooms for any reason.
- Do not spray any spray products near the oven.
- Do not use plastic cookware or containers when cooking food.
- Cooking vessels or griddle plates should be placed inside the perimeter of the hob.



Instructions

- All pans must have smooth, flat bottoms.
- If any liquid does boil over or spill, remove the excess from the hob.
- Take care not to spill acid substances such as lemon juice or vinegar on the hob.
- Do not put empty pans or frying pans on switched on cooking zones.
- Do not use steam jets to clean the appliance.
- Do not use rough or abrasive materials or sharp metal scrapers.
- Do not use cleaning products containing chlorine, ammonia or bleach on parts made of steel or that have metallic surface finishes (e.g. anodizing, nickel- or chromium-plating).
- Do not use abrasive or corrosive detergents (e.g. scouring powders, stain removers and metallic sponges) on glass parts.
- Do not wash removable parts such as the hob grids, flame-spreader crowns and burner caps in the dishwasher.

Installation

- This appliance **must not be installed** in a boat or caravan.
- The appliance must not be installed on a pedestal.
- Position the appliance into the cabinet cut-out with the help of a second person.
- To avoid potential overheating, the appliance must not be installed behind a decorative door or a panel.
- Always use any necessary/required personal protective equipment (PPE) before performing any work on the appliance (installation, maintenance, positioning or movement).
- Before performing any work on the appliance, switch off the power supply.
- Have qualified personnel carry out installation and assistance interventions according to the standards in force.
- Have the gas connection performed by authorised technical personnel.



- Installation using a hose must be carried out so that the length of the hose does not exceed 2 metres when fully extended for steel hoses and 1.5 metres for rubber hoses.
- The hoses should not come into contact with moving parts and should not be crushed in any way.
- If required, use a pressure regulator that complies with current regulations.
- After carrying out any operation, check that the tightening torque of gas connections is between 10 Nm and 15 Nm.
- At the end of the installation, check for any leaks with a soapy solution, never with a flame.
- Have the electrical connection performed by authorised technical personnel.
- The appliance must be connected to earth in compliance with electrical system safety standards.
- Use cables withstanding a temperature of at least 90°C.
- The tightening torque of the screws of the terminal supply wires must be 1.5 - 2 Nm.
- If it is necessary to replace the power cable, this must only be performed by a qualified technician.

For this appliance

- After use, switch off the plates. Never rely solely on the cookware detector.
- Supervise children carefully as they cannot readily see the residual heat indication. After use the cooking zones remain hot for a certain period of time even if they have been turned off. Keep children away from the cooking zones.
- The glass ceramic surface is highly resistant to impact. However, prevent hard, solid objects from falling on the cooking surface as they may cause it to break if they are sharp.
- The glass ceramic cooking surface must not be used as a surface for placing objects.



Instructions

- If cracks or fissures form, or if the glass ceramic cooking surface breaks, turn off the appliance immediately. Disconnect the power supply and call Technical Support.
- People who have pacemakers or other similar devices fitted must make sure that the operation of these devices is not jeopardised by the inductive field, whose frequency range is between 20 and 50 kHz.
- In conformity with the provisions regarding electromagnetic compatibility, the electromagnetic induction cooking hob comes under group 2 and class B (EN 55011).

1.2 Appliance purpose

- This appliance is intended for cooking food in the home environment. Every other use is considered improper.
- The appliance is not designed to operate with external timers or with remote-control systems.

1.3 Manufacturer liability

The manufacturer declines all liability for damage to persons or property caused by:

- Use of the appliance other than that specified;
- Failure to comply with the instructions in the user manual;
- Tampering with any part of the appliance;
- The use of non-original spare parts.

1.4 This user manual

This user manual is an integral part of the appliance and must therefore be kept in its entirety and within the user's reach for the whole working life of the appliance.

Read this user manual carefully before using the appliance.

1.5 Identification plate

The identification plate bears the technical data, serial number and brand name of the appliance. Do not remove the identification plate for any reason.



1.6 Disposal



This appliance must be disposed of separately from other waste (Directives 2002/95/EC, 2002/96/EC, 2003/108/EC). The appliance does not contain substances in quantities sufficient to be considered hazardous to health and the environment, in accordance with current European directives.

To dispose of the appliance:

- Cut the power supply cable and remove it along with the plug.



Power voltage

Danger of electrocution

- Disconnect the mains power supply.
- Unplug the appliance.

- Deliver the appliance to the appropriate recycling centre for electrical and electronic equipment waste, or return it to the retailer when purchasing an equivalent product, on a one for one basis.

Our appliances are packaged in non-polluting and recyclable materials.

- Deliver the packing materials to the appropriate recycling centre.



Plastic packaging

Danger of suffocation

- Do not leave the packaging or any part of it unattended.
- Do not let children play with the plastic bags.



Instructions

1.7 How to read the user manual

This user manual uses the following reading conventions:

Instructions



General information on this user manual, on safety and final disposal.

Description



Description of the appliance and its accessories.

Use



Information on the use of the appliance and its accessories, cooking advice.

Cleaning and maintenance



Information for proper cleaning and maintenance of the appliance.

Installation



Information for the qualified technician: Installation, operation and inspection.



Safety instructions



Information



Advice

1. Sequence of instructions for use.

- Standalone instruction.



2 Description

2.1 General Description

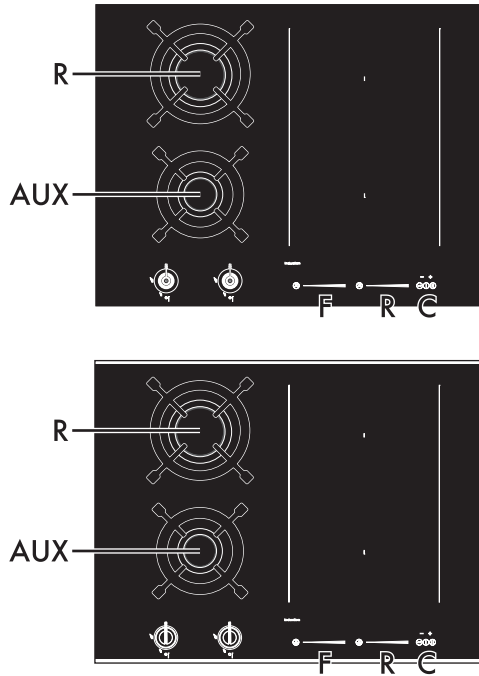

65 cm

AUX = Auxiliary

R = Rapid

F = Front plate controls

R = Rear plate controls

C = General controls zone



Description

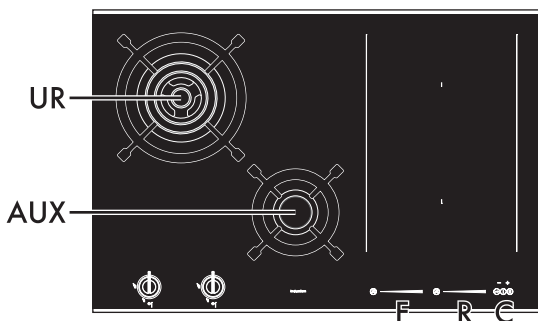
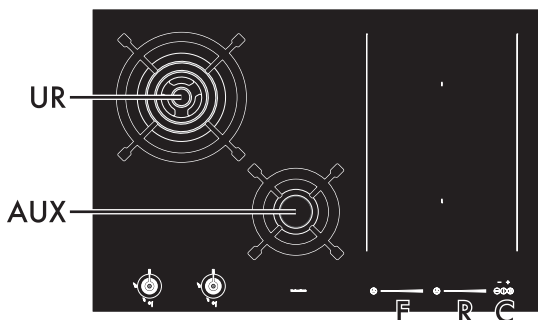

75 cm

AUX = Auxiliary
UR = Ultra rapid

F = Front plate controls
R = Rear plate controls
C = General controls zone

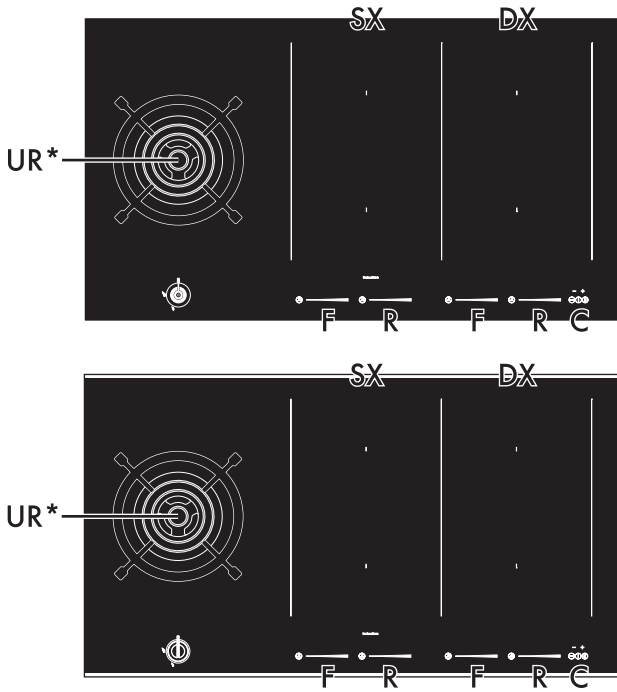

90 cm

UR* = Ultra rapid

SX = Left induction cooking zone

DX = Right induction cooking zone

F = Front plate controls

R = Rear plate controls

C = General controls zone



Description

2.2 Symbols





Gas cooking zone

Rear cooking zone

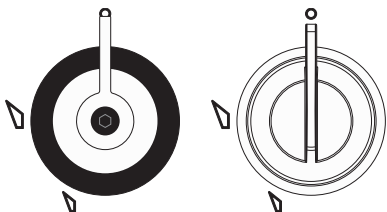
Front cooking zone

Burner knobs





For lighting and adjusting the hob burners. Press and turn the knobs anti-clockwise to  in order to light the relative burners. Turn the knobs to the zone between the maximum  and minimum  setting to adjust the flame. Return the knobs to the position  to turn off the burners.

Induction cooking zone

 On/Off key: turns the hob on or off.

 Pause key: pauses cooking.

 Controls lock key: prevents accidental operation of controls.

 Increase key: increases the cooking time or timer.

 Decrease key: decreases the cooking time or timer.



Scroll bar: increases or decreases the power level.

 Special functions key: activates the appliance's special functions.

Table of power draws

Large	Plate measurements (mm)	Max. power absorbed (W)*	Power absorbed in Power function (W)*
F - R	230 x 180	2100	3700

* power levels are approximate and may vary according to the pan used or the settings made.



Advantages of induction cooking

i The appliance is equipped with an induction generator for each cooking zone. Each generator located under the glass ceramic cooking surface creates an electromagnetic field which induces a thermal current in the base of the pan. This means the heat is no longer transmitted from the hob to the pan but created directly inside the pan by the inductive current.

- Energy saving thanks to the direct transmission of energy to the pan (suitable magnetisable cookware is required) compared to traditional electric cooking.
- Improved safety as the energy is only transmitted to the pan placed on the hob.
- High level of energy transmitted from the induction cooking zone to the base of the pan.
- Rapid heating speed.
- Reduced danger of burns as the cooking surface is only heated under the base of the pan; foods which overflow do not stick.

2.3 Available accessories

WOK ring

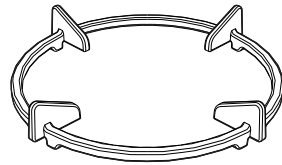

Useful when using a wok.

Scraper

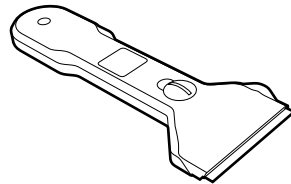

Useful for cleaning the hob.

i The accessories intended to come into contact with food are made of materials that comply with the provisions of current legislation.

i Original supplied and optional accessories can be requested to Authorised Assistance Centres. Use only original accessories supplied by the manufacturer.



3 Use

3.1 Instructions



Improper use Danger of burns

- Make sure that the flame-spreader crowns are correctly positioned in their housings with their respective burner caps.
- Do not leave the appliance unattended during cooking operations where fats or oils could be released.
- Oils and fats could catch fire if overheated. Be very careful.
- Protect your hands by wearing heat-proof gloves during use.
- Do not touch or clean the hob surface during operation or when the residual heat indicator lights are still on.
- Do not put empty pans or frying pans on switched on cooking zones.
- Do not touch the appliance's heating elements when it is running. Leave them to cool before cleaning.
- Activate the controls lock when you have children or pets which could reach the hob.
- After use the cooking zones remain hot for a certain period of time after they have been turned off. Do not touch the hob surfaces.



Improper use Risk of damage to surfaces

- Do not use aluminium foil to cover the burners or hob body.
- Cooking vessels or griddle plates should be placed inside the perimeter of the hob.
- All pans must have smooth, flat bottoms.
- If any liquid does boil over or spill, remove the excess from the hob.
- It is not recommended to use earthenware or steatite (soapstone) pans to cook or heat food.
- Do not use the hob if the pyrolytic cycle is taking place inside any oven installed below.
- Avoid hard, solid objects falling on the cooking surface.
- Do not use the hob as a support surface.



High temperature Danger of fire or explosion

- Do not use or leave flammable materials near the appliance or directly underneath the hob.
- Do not cook in closed tins or containers, plastic kitchenware or containers.
- In case you notice cracks or fissures or you cannot turn off the appliance, disconnect the power supply and contact the Assistance Centre.

3.2 Precautions

A gas leak can cause an explosion.

If you smell gas or there are faults in the gas system:

- Immediately turn off the gas supply or close the valve on the gas cylinder.
- Extinguish all naked flames and cigarettes.
- Do not turn on power switches or appliances and do not remove plugs from power sockets. Do not use phones or mobile phones inside the building.
- Open the window in order to ventilate the room.
- Call customer assistance services or your gas supplier.

Malfunctions

Any of the following indicate a malfunction and you should contact a service centre.

- Damage to kitchen utensils.
- The burners do not ignite properly.
- It is difficult to keep the burners lit.
- The burners go out when the appliance is in use.
- It is difficult to turn the gas valves.

If the appliance does not work properly, contact your local Authorised Service Centre.

3.3 First use

1. Remove any protective film from the outside or inside of the appliance, including accessories.
2. Remove any labels (apart from the technical data plate) from accessories.
3. Remove and wash all the appliance accessories (see 4 Cleaning and maintenance).



3.4 Using the gas burners

All the appliance's control and monitoring devices are located together on the front panel. The burner controlled by each knob is shown next to the knob. The appliance is equipped with an electronic ignition device. Simply press the knob and turn it anti-clockwise to the maximum flame symbol, until the burner ignites. If the burner does not light in the first 15 seconds, turn the knob to  and wait 60 seconds before trying again. After lighting, keep the knob pressed in for a few seconds to allow the thermocouple to heat up.

The burner may go out when the knob is released: In this case, the thermocouple has not heated up sufficiently. Wait a few moments and repeat the operation. Keep the knob pressed in longer.



In case of an accidental switching off, a safety device will be tripped, cutting off the gas supply, even if the gas cock is open. Return the knob to  and wait at least 60 seconds before lighting it again.

Correct positioning of the flame-spreader crowns and burner caps

Before lighting the hob burners, make sure that the flame-spreader crowns are correctly positioned in their housings with their respective burner caps. Make sure that the holes in the burners are aligned with the igniters and thermocouples. Also ensure that the flame-spreader crowns are correctly engaged in the burner holes.

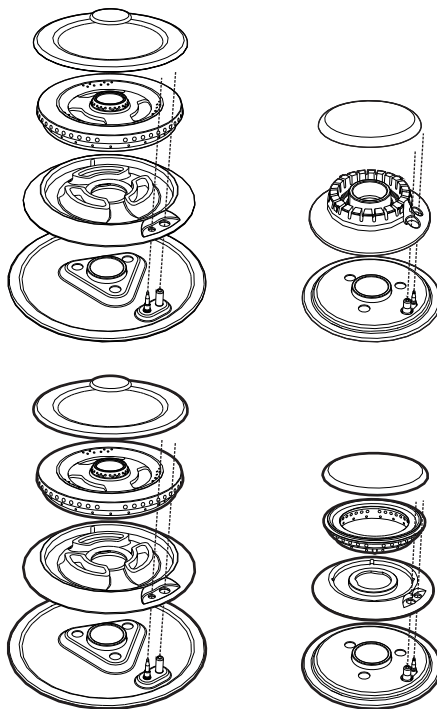



Correct positioning of the grids

Under the grids there are silicone rests with a hole that must be centred onto the matching fixing pins on the surface.

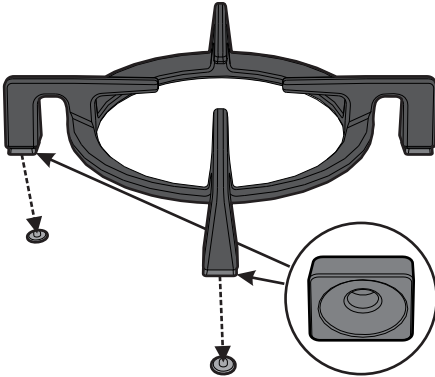

Make sure that the grids are simply centred on their respective burners, without forcing the burners to be raised or tilted. If this is the case, repeat the positioning procedure. If you find that a pan is particularly unstable, make sure that the grids have not been positioned incorrectly.

Cookware diameters



- **AUX:** from 8 to 18 cm.
- **R:** from 20 to 26 cm.
- **UR:** from 20 to 30 cm.

Ring reducers

The ring reducers must be rested on the hob grid. Make sure they are properly positioned.

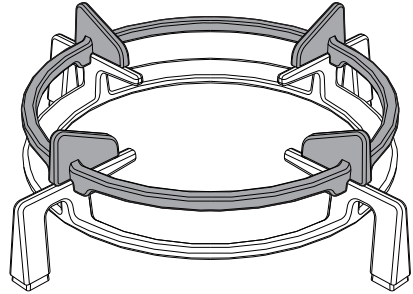

Using a griddle

A few precautions are necessary if you wish to use a griddle:

- The griddle can be pre-heated with the burner on maximum power for no more than 10 minutes.
- It is recommended you reduce the power during cooking;
- Do not allow the burner flames to extend beyond the edge of the griddle;
- Leave a gap of at least 150 mm between the edge of the griddle and the side wall;
- Do not place the griddle over more than one burner at the same time.



3.5 Using the induction hot plates



On first connection to the electrical mains, an automatic check will be carried out that will switch on all indicator lights for a few seconds.

All the appliance's control and monitoring devices are located together on the front panel. The induction hob is controlled by means of the Touch control sensor keys. Lightly touch a symbol on the glass ceramic surface. A beep will sound to confirm every effective touch.

Cookware suitable for use in induction cooking

Cookware used on the induction cooking surface must be made of metal, with magnetic properties and a sufficiently large base.

Suitable cookware:

- Enamelled steel cookware with thick bases.
- Cast iron cookware with an enamelled base.
- Cookware in multilayer stainless steel, ferritic stainless steel and aluminium with a special base.

Unsuitable cookware:

- Copper, stainless steel, aluminium, fireproof glass, wood, ceramic and terracotta cookware.

To see whether the pan is suitable, bring a magnet close to the bottom: if it is attracted, the pan is suitable for induction cooking. If you do not have a magnet, you can put a small amount of water in the pan, place it on a cooking zone and start the hot plate. If

the symbol  appears on the display, it means the pan is not suitable.

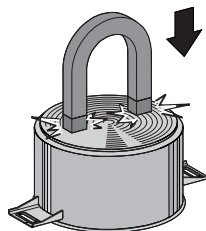

Use only cookware with a perfectly flat bottom which is suitable for induction hot plates. Using cookware with an irregular bottom could jeopardise the efficiency of the heating system and prevent cookware from being detected on the cooking zone.

Minimum cookware diameter

Large	minimum Ø (cm)	recommended Ø (cm)
F - R	9	11.5
Multizone	2 x 11 1 x 22	2 x 13.5 1 x 24.5



Limiting the cooking duration

The hob has an automatic device which limits the duration of use.

If the cooking zone settings are not changed, the maximum duration of operation for each zone depends on the power level selected.

When the device for limiting the duration of use is activated, the cooking zone turns off, a short alert sounds and, if the zone is hot, the symbol  appears on the display.

Power level	Maximum cooking time
1	8 and a half hours
2	6 and a half hours
3	5 and a half hours
4	4 and a half hours
5	3 and a half hours
6	2 and a half hours
7	2 and a half hours
8	2 hours
9	1 and a half hours

Protection from overheating

If the hob is used on full power for a long period, the electronics will have trouble cooling down if the room temperature is high.

To avoid excessively high temperatures forming in the electronics, the power to the cooking zone is reduced automatically.



Power levels

The power in the cooking zone can be adjusted to various levels. The table shows the levels suitable for various types of cooking.

Power level	Suitable for:
0	OFF setting
1 - 2	Cooking small amounts of food (minimum power)
3 - 4	Cooking
5 - 6	Cooking large quantities of food, roasting larger portions
7 - 8	Roasting, slow frying with flour
9	Roasting
p *	Roasting / browning, cooking (maximum power)

* see Power function

Switching the hob on and off

To activate the hob keep the On/Off key  pressed for at least 1 second. To deactivate the hob keep the On/Off key  pressed for at least 2 seconds.



If no power value is selected within a few seconds, the hob is automatically deactivated.



Switching on the cooking zone automatically

After switching on the hob:

- Position a pan (suitable for induction cooking and not empty) on the cooking zone you wish to use.



The display of the cooking zone used will turn on: the power value indicated is 



Adjusting the cooking zone

After switching on the hob:

1. Place a finger on the left-hand side of the scroll bar of the cooking zone to be used.



The display of the cooking zone used will turn on: the power value indicated is 

2. Move your finger to the left or right on the scroll bar to select the cooking power, between  and , or else activate the Power function (see "Power Function").

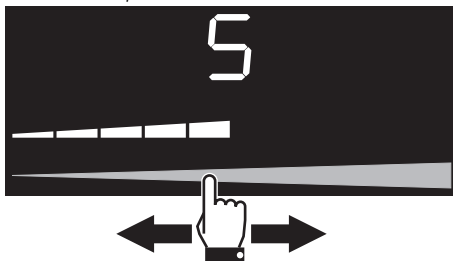

The display of the cooking zone used will show the set cooking power.

Switching off the cooking zone

1. Move your finger all the way to the left on the scroll bar of the cooking zone you wish to turn off.



The display for the cooking zone will turn off.



Hold the On/Off key  down for at least 2 seconds to switch off all cooking zones at the same time.



Quick selection

i This function allows you to quickly set the cooking zones to the required power.

After switching on the hob:

1. Place a finger on the scroll bar of the cooking zone to be used, at approximately the required power level.

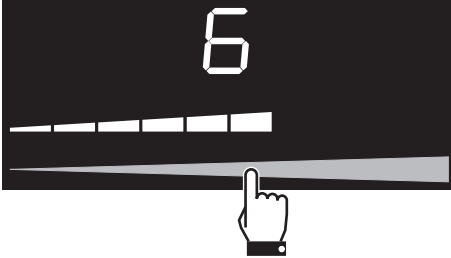

2. Move your finger to the left or right to select the required cooking power.

Power Function

i This function allows you to use the maximum possible power for the cooking zone.

After switching on the hob:

1. Place a finger on the left-hand side of the scroll bar of the cooking zone to be used.



The display of the cooking zone used will turn on: the power value indicated is **!**.

2. Move your finger all the way to the right of the scroll bar to select the Power function.



The display of the cooking zone used will show **P**.

It is possible to perform quick activation of the power function.

- After turning the hob on, place your finger all the way to the right on the scroll bar of the cooking zone you wish to use.



 The Power function is available for 10 minutes, after which the power level drops automatically to 9.



Use

Multizone function

i This function can be used to:
 operate two
 cooking zones (front and rear)
 simultaneously
 when using pans like fish kettles or
 rectangular pans.

After switching on the hob:

1. Simultaneously place one finger on the left-hand scroll bar and another finger on the right-hand scroll bar of the cooking zones you wish to use.

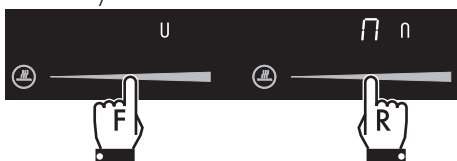

The displays of the cooking zones will turn on: the display shows the "master" **U** symbol while the right-hand display shows **n n** followed by the "slave" **n n** symbol.

2. Use the left-hand scroll bar to set the required cooking power.

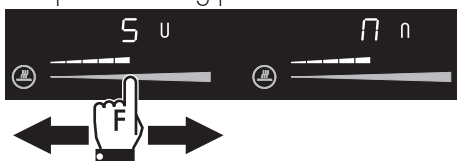

The same parameters are set on both cooking zones.



It is only possible to activate the Multizone function between cooking zones that are vertically connected (**F** and **R**).

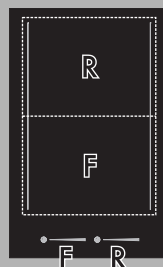

This function automatically divides the power equally between both of the hot plates in use.



When the Multizone function is active, it is not possible to activate the Power function on the relevant cooking zones.



If using a large, oval or oblong pan, ensure that you position this at the centre of the cooking zone.

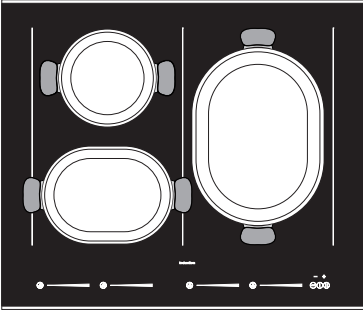

Example of correct pan position

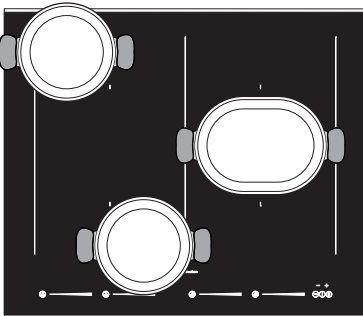

Example of INCORRECT pan position

Cooking guidelines

The table below shows the power values which can be set, together with the corresponding type of food. Settings may vary depending on the amount of food and consumer taste.

Power level	Suitable for:
1 - 2	Reheating food, keeping small amounts of water on the boil, and whipping up sauces with egg yolk or butter.
3 - 4	Cooking solid or liquid food, keeping water on the boil, defrosting deep-frozen food, cooking 2- or 3-egg omelettes, fruit and vegetables, various cooking processes.
5 - 7	Stewing meat, fish and vegetables, simmering food, making jams, etc.
8-9	Cooking or frying meat, fish, steaks and liver; browning meat, fish, eggs, etc.
P	Deep-frying potatoes, etc., or bringing water to the boil rapidly.

To deactivate the Multizone function:

Simultaneously place one finger on the left-hand scroll bar and another finger on the right-hand scroll bar of the cooking zones you wish to turn off.

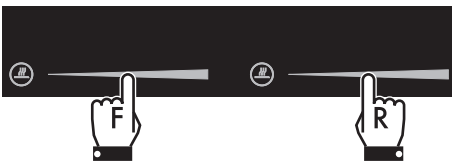



Use

Residual heat



Improper use Danger of burns

- Supervise children carefully as they cannot easily see the residual heat indicator. The cooking zones remain hot for a certain period of time even after they have been turned off. Make sure that children never touch the hob.



If the cooking zone is still hot after being switched off, the symbol  will be displayed on the display. The symbol clears once the temperature drops below 40°C.

Melting function



This function allows you to melt foods.

To activate the Melting function, first turn on the hob, then:

- Press the special functions key  for the required cooking zone once. The display shows  followed by the symbol .

To deactivate the Melting function:



- Press the special functions key  three times.

Keep Warm Function



The Keep warm function allows you to keep cooked food hot.

To activate the Keep Warm function, first turn on the hob, then:

- Press the special functions key  for the required cooking zone twice. The display shows  followed by the symbol .

To deactivate the Keep Warm function:

- Press the special functions key  twice.

Simmering function



This function allows you to keep the liquid in the pan simmering.

To activate the Simmering function, first turn on the hob, then:

- Press the special functions key  for the required cooking zone three times. The display shows  followed by the symbol .

To deactivate the Simmering function:



- Press the special functions key  once.



Pause function

i This function pauses the operation of all cooking zones.

The Pause function can be activated when at least one cooking zone is switched on:

- Hold down the pause key . The display shows an LED above the pause key  and the message  on the displays of all the cooking zones.

 All the hob's keys will be disabled, except for the controls lock key. All cooking zones will switch off.

To deactivate the Pause function:

1. Press the key .

The rightmost cooking zone display will show an animation for a few seconds.

2. Place a finger on the left-hand side of the scroll bar and slide it to the right.

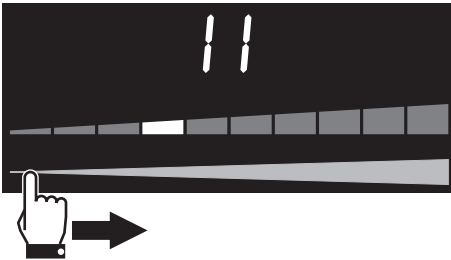



 If no key is pressed within 5 seconds, the hob will turn off automatically.

Controls lock



i This function disables all display keys to prevent operation by children or accidental selection.

To activate the Controls lock, first turn on the hob, then:

- Hold down the controls lock key  for 3 seconds. The display will show an LED above the controls lock key. .

 The controls lock will not be deactivated in the event of a power cut.

To deactivate the Controls lock:

- Hold down the controls lock key  for 3 seconds. The LED above the controls lock key  will turn off.



Use

Timer



This function is used to set a timer which will sound a buzzer at the end of the pre-set time.

To activate the timer, first turn on the hob, then:

1. Press the timer keys and at the same time.

The display will show the time indicator

. The timer symbol below the time indicator shows that the function has been activated.

2. Press the timer keys and to set the timer (hold down to advance quickly).

The display is set to "minutes.seconds". On the first press of the timer key , 1 minute

is set. It is possible to set a time shorter than one minute:

- Press the timer key between 1 and 5 times to select a timer of less than one minute (from to seconds).

With each press of the timer key , the time decreases by 10 seconds.

If the setting exceeds 9 minutes , the message will be shown under the time indicator and the display will be set to "hours.minutes" (up to a maximum of 1 hour, 59 minutes)

3. The timer will start a few seconds after the last selection.



Using the minute minder does not stop the operation of the cooking zones but rather informs the user when the set minutes have run out.



The timer can be activated while the cooking zones are on or off.

At the end of the set time, a buzzer tells the user that the Minute minder has finished.

4. To deactivate the buzzer, press the timer key or .

Deactivating the timer

To deactivate the timer during the countdown:

1. Press the On/Off key .

The LED above the On/Off key will turn on.

2. Press the timer keys and at the same time.

The countdown will be interrupted.

3. Hold down the timer key until the countdown is reset.



Timed cooking



This function is used to program the automatic switch-off of each cooking zone at the end of a period of time.

The timed cooking function can be activated when at least one cooking zone is switched on:

1. Press the timer keys and at the same time.

The display will show the time indicator

The timer symbol next to the power level value of the plate indicates that the function is activated.

2. Press the timer keys and to set timed cooking (hold down to advance quickly).

The display is set to "minutes.seconds". If the setting exceeds 9 minutes

the message will be shown under the time indicator and the display will be set to "hours.minutes" (up to a maximum of 1 hour, 59 minutes).

3. Timed cooking will start a few seconds after the last selection.

At the end of the set time, a buzzer tells the user that the Minute minder has finished.

4. To deactivate the buzzer, press the timer key or .



This function can be activated on multiple cooking zones at the same time. The flashing LED and time indicator refer to the next cooking zone to be switched off.

EN

Modifying or deactivating timed cooking

To modify timed cooking during the countdown:

1. Press the On/Off key .

The LED above the On/Off key will turn on.

2. Press the timer keys and at the same time.

The countdown will be interrupted.

3. Press the timer keys and to modify the timed cooking settings.

To deactivate timed cooking during the countdown:

1. Press the On/Off key .

The LED above the On/Off key will turn on.

2. Press the timer keys and at the same time.

The countdown will be interrupted.

3. Hold down the timer key until the countdown is reset.





Use

Demo mode (for showrooms only)



i This mode allows the appliance to deactivate all heating elements, while keeping the control panel active.

To activate demo mode:



1. Make sure that the appliance has been disconnected from the mains power supply for at least 10 -15 seconds.
2. Connect the appliance to the mains power supply.
3. Within 2 minutes, press the controls lock key  and the pause key  simultaneously for a few seconds until you hear an acoustic signal.
4. Simultaneously place a finger on the left-hand side and right-hand side scroll bars of the cooking zone closest to the general controls area.

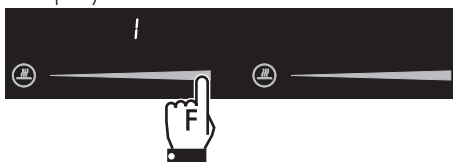

An acoustic signal is emitted and **CF6** will appear on the display above the general controls area.

5. Press the pause key  until **_0_** appears on the display above the general controls area.  will be displayed on the left hand scroll bar.
6. Place a finger on the top part of the left-hand side scroll bar until  is displayed.





7. Press the controls lock key  and the pause key  simultaneously for a few seconds.
8. Press and hold down the On/Off key  for at least 1 second in order to switch on the appliance in demo mode.

i If the demo mode is enabled, when the appliance is switched on **_0_** will appear for a few seconds in the area above the general controls area and  will appear on the scroll bars.





To disable demo mode:

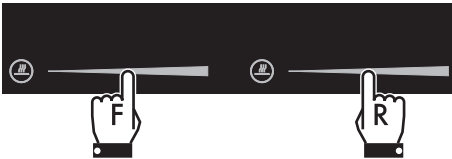

1. Make sure that the appliance has been disconnected from the mains power supply for at least 10 -15 seconds.
2. Connect the appliance to the mains power supply.
3. Within 2 minutes, press the controls lock key  and the pause key  simultaneously for a few seconds until you hear an acoustic signal.
4. Simultaneously place a finger on the left hand side and right hand side scroll bars of the cooking zone closest to the general controls area.

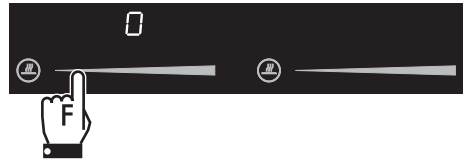

An acoustic signal is emitted and **CF6** will appear on the display above the general controls area.

5. Press the pause key  until **_0_** appears on the display above the general controls area.  will be displayed on the left hand side scroll bar.
6. Place a finger on the bottom part of the left-hand side scroll bar until  is displayed.



7. Press the controls lock key  and the pause key  simultaneously for a few seconds.

Demo mode has now been disabled.

NE



3.6 Practical advice

- For better burner efficiency and to minimise gas consumption, use pans with lids and of suitable size for the burner, so that the flames do not reach up the sides of the pan. Once the contents come to the boil, turn down the flame far enough to ensure that the liquid does not boil over.
- To prevent burns or damage to the hob or the counter top during cooking, all pans or griddles (not supplied) must be placed inside the perimeter of the hob.

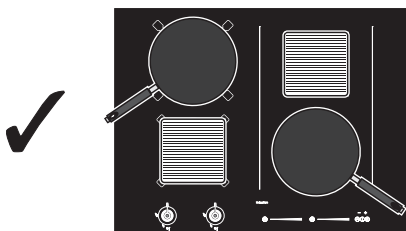
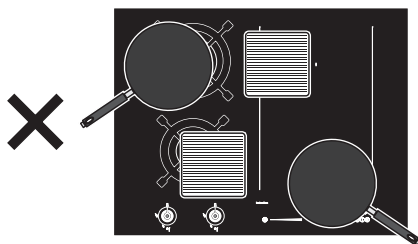

- The diameter of the base of the pan must not exceed the width of the silk-screened cooking zone.
- Pans must not be placed outside the perimeter of the hob or above the front control panel.
- When buying a pan, check whether the diameter indicated is that of the base or the top of the pan, as the top is almost always larger than the base.
- When preparing dishes with long cooking times, you can save time and energy by using a pressure cooker, which also makes it possible to preserve the vitamins in the food.
- Make sure that the pressure cooker contains enough liquid as, if there is not enough and it overheats, this may cause damage to both the pressure cooker and the cooking zone.
- If possible, always cover pans with a suitable lid.
- Choose a pan suitable for the quantity of food to be cooked. A large, half-empty saucepan leads to a waste of energy.



Under certain circumstances, if the hob and the oven are being used at the same time, the maximum power limit that can be used by the electrical system might be exceeded.



4 Cleaning and maintenance

4.1 Instructions



Improper use Risk of damage to surfaces

- Do not use steam jets to clean the appliance.
- Do not use cleaning products containing chlorine, ammonia or bleach on parts made of steel or that have metallic surface finishes (e.g. anodizing, nickel- or chromium-plating).
- Do not use abrasive or corrosive detergents (e.g. scouring powders, stain removers and metallic sponges) on glass parts.
- Do not use rough or abrasive materials or sharp metal scrapers.
- Do not wash removable parts such as the hob grids, flame-spreader crowns and burner caps in the dishwasher.
- Do not use steam jets to clean the appliance.
- Do not spill sugar or sweet mixtures on the hob during cooking.
- Do not place materials or substances that could melt (plastic or aluminium foil).
- Keep sensor keys clean at all times and do not rest any object on them.

4.2 Cleaning the appliance

To keep the surfaces in good condition, they should be cleaned regularly after use. Let them cool first.

Ordinary daily cleaning

Always use specific products only that do not contain abrasives or chlorine-based acids.

Pour the product onto a damp cloth and wipe the surface, rinse thoroughly and dry with a soft cloth or a microfibre cloth.

Clean and maintain the hob once a week using an ordinary glass cleaning product. Always follow the manufacturer's instructions. The silicon in these products creates a protective, water-repellent membrane which also resists dirt. All marks stay on the membrane and can therefore be removed easily. After cleaning, dry the surface with a clean cloth. Make sure that there is no detergent left on the cooking surface as it will undergo a corrosive reaction when heated up and could modify the structure of the cooking surface.



Cleaning and maintenance

Food stains or residues

Do not use steel sponges and sharp scrapers as they will damage the surface.

Use normal, non-abrasive products and a wooden or plastic tool, if necessary. Rinse thoroughly and dry with a soft cloth or a microfibre cloth.

Do not allow residues of sugary foods (such as jam) to set inside the oven. If left to set for too long, they might damage the enamel lining of the oven.

Light coloured marks from pans with aluminium bases can be easily cleaned off with a cloth moistened in vinegar.

After cooking, remove any burnt residues with the scraper provided; rinse with water and dry thoroughly with a clean cloth.

Regular use of the scraper considerably reduces the need for chemical detergents for the daily cleaning of the hob.

Dirt which may have fallen on the hob while cleaning lettuce or potatoes can scratch the hob when moving pans.

Consequently, remove any dirt from the cooking surface immediately.

Changes in colour do not affect the operation and stability of the glass. These are not alterations to the material of the hob but just residues which have not been removed and have then carbonised.

Shiny surfaces can form due to the bases of pans, especially aluminium ones, rubbing on the surface, and due to the use of unsuitable detergents. They are difficult to remove using conventional cleaning products. It may be necessary to repeat the cleaning process several times. Use of corrosive detergents or rubbing of pan bases can wear away the decoration on the hob over time and contribute to the formation of stains.

Cooking hob grids

Remove the grids and clean them in lukewarm water and non-abrasive detergent. Make sure to remove any encrustations. Dry them thoroughly and return them to the hob.



The continuous contact between the grids and the flame can cause modifications to the enamel over time in those parts exposed to heat. This is a completely natural phenomenon which has no effect on the operation of this component.



Flame-spreader crowns and burner caps

For easier cleaning, the flame-spreader crowns and the burner caps can be removed. Wash them in hot water and non-abrasive detergent. Carefully remove any encrustation, then wait until they are perfectly dry. Refit the flame-spreader crowns, making sure that they are correctly positioned in their housings with their respective burner caps.

Igniters and thermocouples

For correct operation the igniters and thermocouples must always be perfectly clean. Check them frequently and clean them with a damp cloth if necessary. Remove any dry residues with a wooden toothpick or a needle.

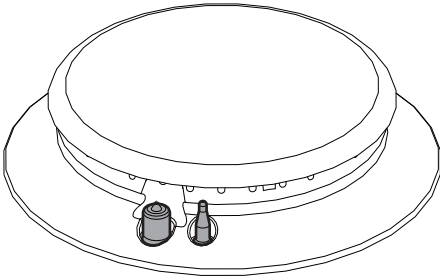

4.3 What to do if...

The hob does not work:

- Make sure that the hob is connected and that the main switch is turned on.
- Make sure that there is no power failure.
- Make sure that the fuse has not blown. In this case replace the fuse.
- Make sure that the circuit breaker of the residential electrical system has not tripped. In this case, reset the circuit breaker.

The cooking results are unsatisfactory:

- Make sure that the cooking temperature is not too high or too low.

The hob smokes:

- Let the hob cool down and clean it once cooking is complete.
- Make sure that the food has not spilled out of the pan and use a larger cooking vessel, if needed.

The fuses blow or the circuit breaker of the residential electrical system trips repeatedly.

- Call Technical Support or an electrician.

There are cracks or fissures in the hob:

- Turn off the appliance immediately, disconnect the power supply and contact Technical Support.



Installation

5 Installation

5.1 Safety instructions



Heat production during appliance operation
Risk of fire

- Check that the carcass material is heat resistant.
- Check that the carcass has the required openings.

Veneers, adhesives or plastic coatings on adjacent furniture should be temperature-resistant (>90°C), otherwise they might warp over time.



The minimum clearance between a ventilation hood and the cooking surface must be at least the distance indicated in the ventilation hood installation instructions.

The minimum clearances must also be respected for the edges of the hob on the back as indicated in the mounting illustrations.

5.2 Section cut from the countertop



The following operation requires building and/or carpentry work and must therefore be carried out by a competent tradesman.

Installation can be carried out on various materials such as masonry, metal, solid wood or plastic laminated wood as long as they are heat resistant (>90°C).

Create an opening with the dimensions shown in the figure in the countertop of the unit (mm).

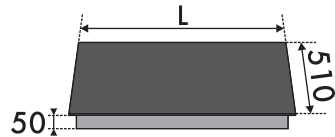

L	X	Y
650	560 - 564	482 - 486
750	560 - 564	482 - 486
900	844 - 848	482 - 486

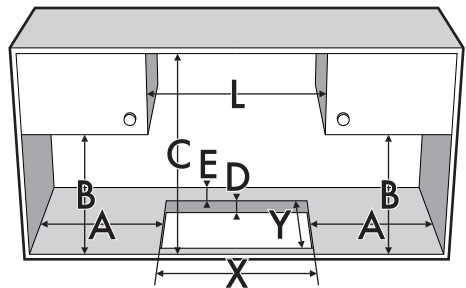

A	B	C	D	E
min. 200	min. 460	min. 750	40÷60	min. 50



Appliance dimensions (mm)

Position of gas and electrical connections.
(seen from below)

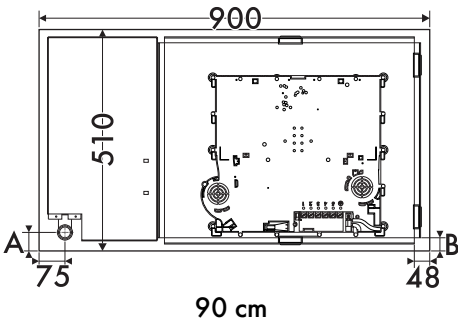
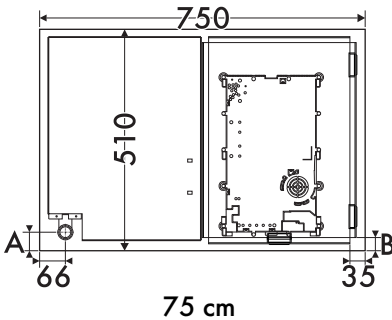
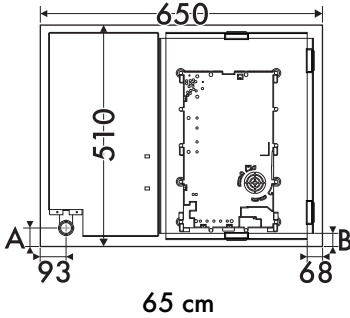

Flush installation (version without strips only)

After laying the adhesive seal (A) on the glass surface and after positioning and securing the hob, fill the edges with insulating silicone (B) and wipe away any excess.

In the event the hob needs to be removed, cut the silicone using a cutter before attempting to remove it (C).

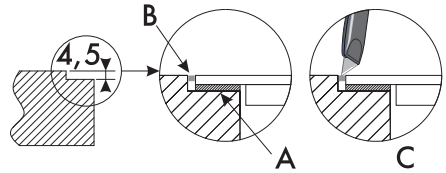

Dimensions flush with top (mm)

X = Gas Connection

Y = Electrical connection

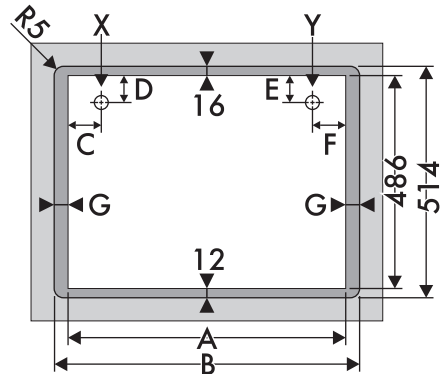

A	B	C	D	E	F	G
560	654	47.5	21	20	57.5	47
724	754	53	21	20	57	15
844	904	47	23	33.5	96.5	30

A	35
B	34.5



Installation

5.3 Mounting

Over built-in oven unit

The clearance between the hob and the kitchen furniture or other installed appliances must be enough to ensure sufficient ventilation and air discharge. If installed above an oven, a space must be left between the bottom of the hob and the top of the appliance installed below.

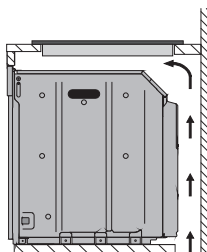

opens on bottom

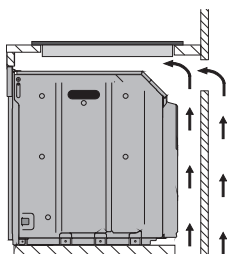

opens on bottom and on rear

Over empty kitchen unit or drawers

If there are other pieces of furniture (lateral walls, drawers, etc.), dishwashers or fridges under the hob, a double-layer wooden base must be installed at least **20 mm** from the bottom of the hob to avoid any accidental contact. It must only be possible to remove the double-layer base using suitable equipment.

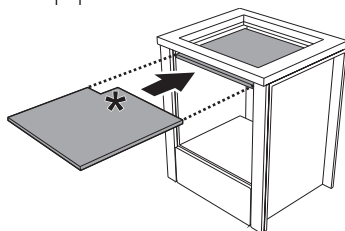

* 150 x 150 (mm)
required for gas connection

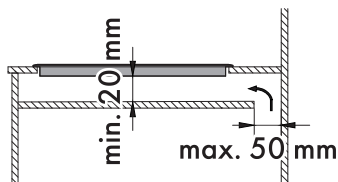

opens on bottom

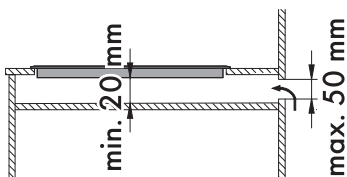

opens on rear



If installed on top of an oven, the latter must be equipped with a cooling fan.



Failure to install the double-layer wooden base exposes the user to possible accidental contact with sharp or hot parts.



Hob seal

With glass hob

To prevent leakage of liquid between the frame of the hob and the countertop, place the adhesive seal provided along the entire outer edge of the hob before assembly.

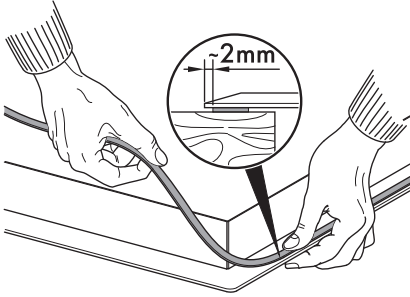

Spring clips

To ensure the hob is fixed and centred as accurately as possible, the clips provided must be positioned as described below:

1. Fit the clips by gently pressing them horizontally into the appropriate space.

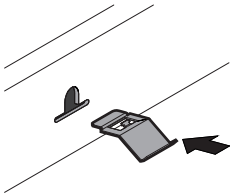

2. Then turn them upwards to fix them in place.

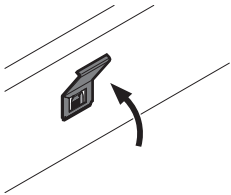

Position of slot for clips

(seen from below)

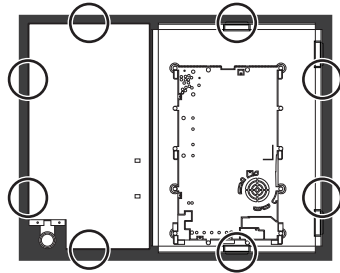

65 cm

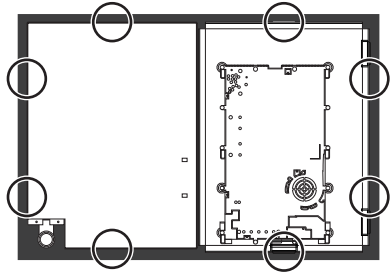

75 cm

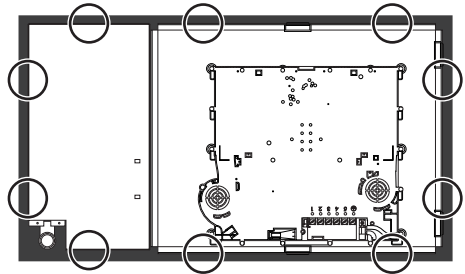

90 cm

EN



Installation

Ventilation

The illustrations below show two examples of installation suitable for proper ventilation and one example of incorrect installation to be avoided.

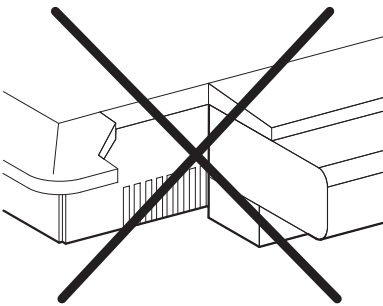
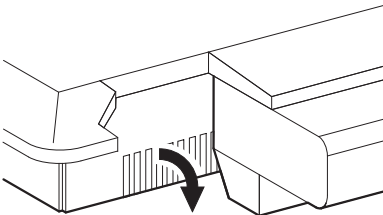
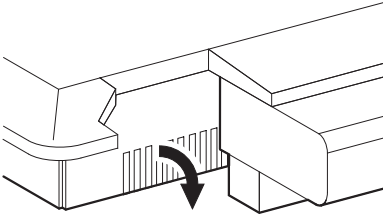

5.4 Gas connection



**Gas leak
Danger of explosion**

- After carrying out any operation, check that the tightening torque of gas connections is between 10 Nm and 15 Nm.
- If required, use a pressure regulator that complies with current regulations.
- At the end of the installation, check for any leaks with a soapy solution, never with a flame.
- The hoses should not come into contact with moving parts and should not be crushed in any way.

General information

Connection to the gas mains can be made using a rigid copper pipe or a continuous wall steel hose in compliance with the provisions established by the applicable standard.

For supplying it with other types of gas, see chapter "5.5 Adaptation to different types of gas". The gas inlet connection is threaded 1/2" external gas (ISO 228-1).



Connection with a steel hose with conical fitting

Make the connection to the gas mains using a continuous wall steel hose whose specifications comply with the applicable standard.

Carefully screw the hose connector **3** to the appliance's gas connector **1** ($\frac{1}{2}$ " thread ISO 228-1), placing the supplied seal **2** between them. Apply insulating material to the thread of connector **3**, then tighten the steel hose **4** to the connector **3**.

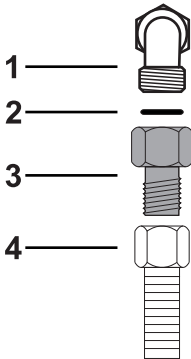

Connection with a steel hose

Make the connection to the gas mains using a continuous wall steel hose whose specifications comply with the applicable standard.

Carefully screw the connector **3** to the gas connector **1** of the appliance, placing the seal **2** between them.

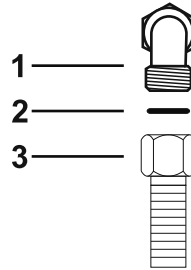

Connection to LPG

Use a pressure regulator and make the connection on the gas cylinder, following all applicable standards and regulations.

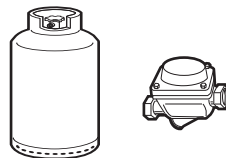

The supply pressure must comply with the values indicated in the table in "Gas types and Countries".



Installation

Room ventilation

The appliance should be installed in rooms that have a permanent air supply in accordance with the standards in force. The room where the appliance is installed must have enough air flow for the regular combustion of gas and the necessary air change in the room itself. The air vents, protected by grilles, must be the right size to comply with current regulations and positioned so that no part of them is obstructed, not even partially.

The room must be kept adequately ventilated in order to eliminate the heat and humidity produced by cooking: In particular, after prolonged use, you are recommended to open a window or to increase the speed of any fans.

Extraction of the combustion products

The combustion products may be extracted by means of hoods connected to a natural draught chimney whose efficiency is certain or via forced extraction. An efficient extraction system requires precision planning by a specialist qualified in this area and must comply with the positions and clearances indicated by the applicable standards.

When the job is complete, the installer must issue a certificate of conformity.

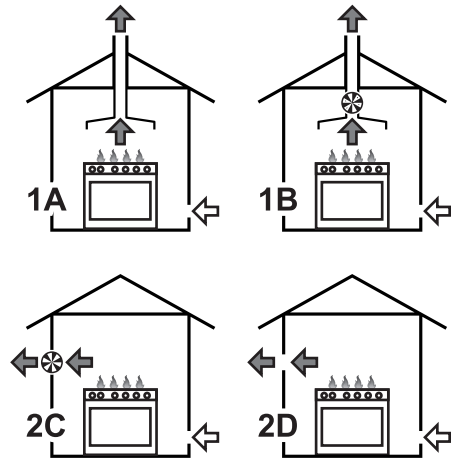

1 Extraction using a hood

2 Extraction without a hood

A Single natural draught chimney

B Single chimney with extractor fan

C Directly outdoors with wall- or window-mounted extractor fan

D Directly outdoors through wall

← Air

← Combustion products

⊗ Extractor fan



5.5 Adaptation to different types of gas

If other types of gas are to be used, the nozzles must be replaced and the primary air must be adjusted. In order to replace the nozzles and adjust the burners, the hob top must be removed.



In order to be able to replace the nozzles, the appliance must be removed from the built-in unit.

Removing the hob top

1. Pull the knobs and the knob bezels (where present) upwards to remove them.

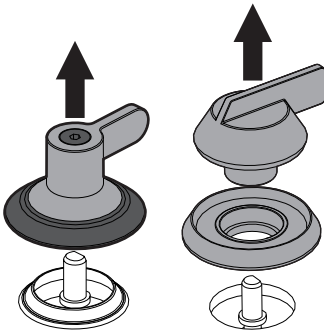

Between knob and knob bezel (depending on the model) there is a spring that is not shown in the figure.

2. Remove the grids from the hob.

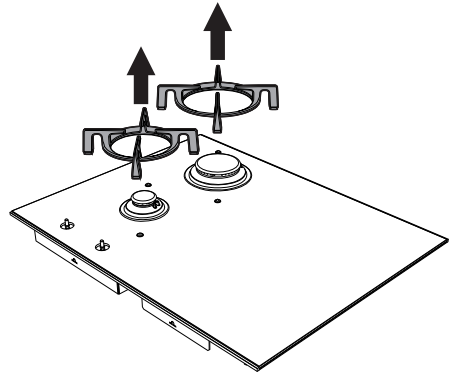

3. Remove the flame-spreader crowns and relative burner caps.

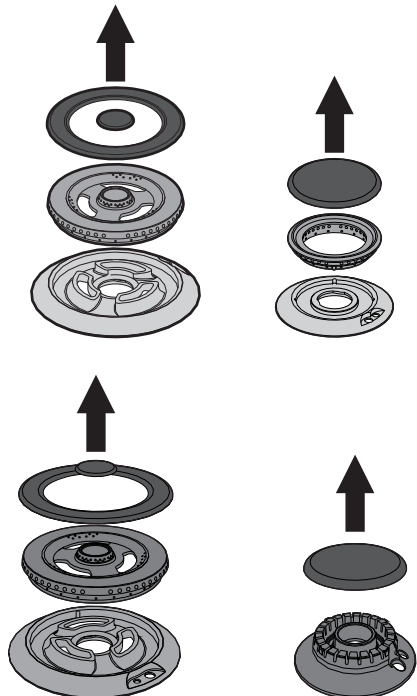



Installation

4. Remove the screws fastening the hob and the plates corresponding to each burner zone.

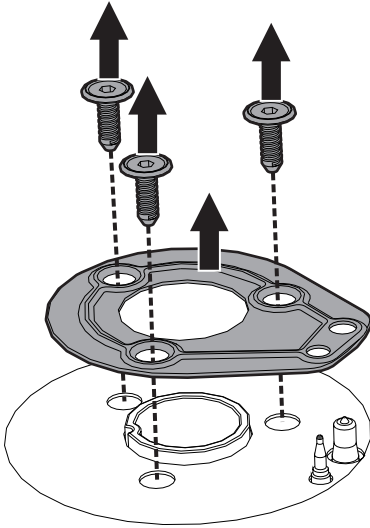

5. Unscrew the 6 screws that hold the glass hob top to the casing (see the figures below for their location).

(seen from below)

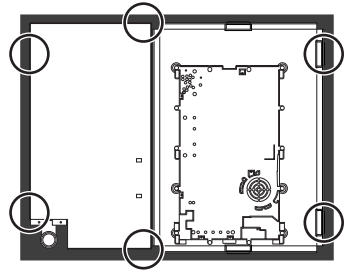

65 cm

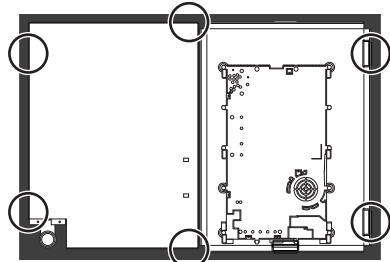

75 cm

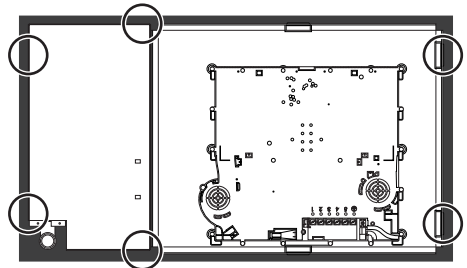

90 cm



Where the UR burner is present, the nut that fixes the thermocouple to the hob top must be unscrewed (CH8).



Under the plates, there may be a number of seals, together with the igniter and thermocouple. Pay attention.



- Remove the glass hob top.

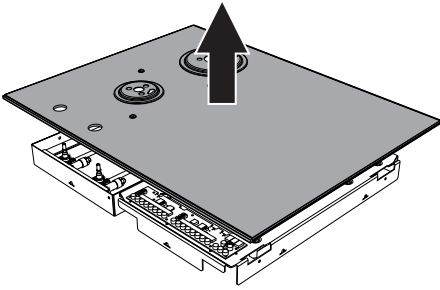

Replacing the nozzles

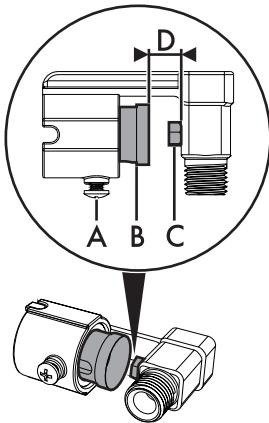

- Unscrew screw **A** and push air regulator **B** as far as it will go.
- Use a spanner to remove the nozzles **C** and install the new ones for the required gas supply, following the indications given in the relevant table (see "Gas types and Countries").

- Adjust the air flow by moving the air regulator **B** to obtain the distance **D** given in the corresponding table (see "Gas types and Countries").
- After adjusting each burner, reassemble the appliance correctly.

Adjusting the minimum setting for natural or town gas

- Light the burner and turn it to the minimum position.
- Extract the gas cock knob and turn the adjustment screw next to the tap rod (depending on the model) until the correct minimum flame is achieved.
- Refit the knob and verify that the burner flame is stable.
- Turn the knob rapidly from the maximum to the minimum setting: The flame should not go out.
- Repeat the operation on all gas cocks.

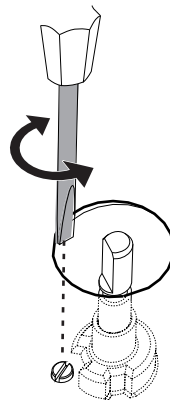

The nozzle tightening torque must be no more than 3 Nm.

Z
E



Installation

Adjusting the minimum setting for LPG

Tighten the screw located at the side of the tap rod clockwise all the way.



Following adjustment to a gas other than the one originally set in the factory, replace the gas setting label on the appliance with the one corresponding to the new gas. The label is inserted inside the nozzle pack (where present).

Lubricating the gas cocks

Over time the gas cocks may become difficult to turn and get blocked. Clean them internally and replace the lubrication grease.



Lubrication of the gas cocks should be performed by a specialised technician.

Re-assembling the hob top

Once the nozzles have been replaced, reassemble the glass hob top as follows:

1. With reference to the gas burners, replace the glass hob top on the casing.
2. For each burner, reposition the seals on the igniter and thermocouple.
3. Reposition the plates on the corresponding burners and secure with the 3 screws (for each burner) that had previously been removed.
4. If present, tighten the nut on the UR burner igniter.
5. Fix the glass hob top to the casing using the 6 screws that had previously been removed (see point 5 of section "Removing the hob top" for their location).
6. Fit the appliance into the cabinet.
7. Reposition the flame-spreader crowns and burner caps on the relative burners.
8. Reposition the grids on the glass hob top.
9. Reposition the knobs and knob bezels (where present) on the tap rods.



Gas types and Countries

Gas types		IT	GB-IE	FR-BE	DE	AT	NL	ES	PT	SE	RU	DK	PL	HU
1 Natural Gas G20														
G20	20 mbar	•	•		•	•		•	•	•	•	•		
G20/25	20/25 mbar			•										
2 Natural Gas G20														
G20	25 mbar													•
3 Natural Gas G25														
G25	25 mbar						•							
G25.3	25 mbar						•							
4 Natural Gas G25.1														
G25.1	25 mbar													•
5 Natural Gas G25														
G25	20 mbar				•									
6 Natural Gas G27														
G27	20 mbar												•	
7 Natural Gas G2.350														
G2.350	13 mbar													•
8 LPG G30/31														
G30/31	28/37 mbar		•	•				•			•			
G30/31	30/37 mbar	•							•					
G30/31	30/30 mbar						•			•		•		
9 LPG G30/31														
G30/31	37 mbar													•
10 LPG G30/31														
G30/31	50 mbar				•	•								
11 Town gas G110														
G110	8 mbar	•								•		•		
12 Town gas G120														
G120	8 mbar									•				

EN



It is possible to identify the available gas types based on the country the appliance is to be installed in. Refer to the heading number to identify the correct values in the "Burner and nozzle characteristics tables".



Installation

Burner and nozzle characteristics tables

1	Natural Gas G20 – 20 mbar	AUX	R	UR	UR*
	Rated heating capacity (kW)	1.1	3.1	3.3	6.0
	Nozzle diameter (1/100 mm)	76	126	130	175
	Reduced flow rate (W)	400	900	1600	1800
	Primary air (mm)	1	1.5	0.5	1.5
2	Natural Gas G20 – 25 mbar	AUX	R	UR	UR*
	Rated heating capacity (kW)	-	-	-	-
	Nozzle diameter (1/100 mm)	-	-	-	-
	Reduced flow rate (W)	-	-	-	-
	Primary air (mm)	-	-	-	-
3	Natural gas G25/G25.3 - 25 mbar	AUX	R	UR	UR*
	Rated heating capacity (kW)	1.1	3.1	3.3	6.0
	Nozzle diameter (1/100 mm)	76	126	135	185
	Reduced flow rate (W)	400	900	1600	1800
	Primary air (mm)	1	1	0.5	0.5
4	Natural gas G25.1 – 25 mbar	AUX	R	UR	UR*
	Rated heating capacity (kW)	-	-	-	-
	Nozzle diameter (1/100 mm)	-	-	-	-
	Reduced flow rate (W)	-	-	-	-
	Primary air (mm)	-	-	-	-
5	Natural Gas G25 – 20 mbar	AUX	R	UR	UR*
	Rated heating capacity (kW)	1.1	3.1	3.3	6.0
	Nozzle diameter (1/100 mm)	82	140	145	200
	Reduced flow rate (W)	400	900	1600	1800
	Primary air (mm)	1	1	0.5	0.5
6	Natural Gas G27 – 20 mbar	AUX	R	UR	UR*
	Rated heating capacity (kW)	-	-	-	-
	Nozzle diameter (1/100 mm)	-	-	-	-
	Reduced flow rate (W)	-	-	-	-
	Primary air (mm)	-	-	-	-
7	Natural gas G2.350 – 13 mbar	AUX	R	UR	UR*
	Rated heating capacity (kW)	-	-	-	-
	Nozzle diameter (1/100 mm)	-	-	-	-
	Reduced flow rate (W)	-	-	-	-
	Primary air (mm)	-	-	-	-

Installation



EN

8	LPG G30/31 - 30/37 mbar	AUX	R	UR	UR*
	Rated heating capacity (kW)	1.0	3.1	3.3	5.9
	Nozzle diameter (1/100 mm)	48	85	87	115
	Reduced flow rate (W)	400	1100	1800	1800
	Primary air (mm)	1.5	2	1.5	12
	Rated flow rate G30 (g/h)	73	225	240	429
	Rated flow rate G31 (g/h)	71	221	236	421
9	LPG G30/31 - 37 mbar	AUX	R	UR	UR*
	Rated heating capacity (kW)	-	-	-	-
	Nozzle diameter (1/100 mm)	-	-	-	-
	Reduced flow rate (W)	-	-	-	-
	Primary air (mm)	-	-	-	-
	Rated flow rate G30 (g/h)	-	-	-	-
	Rated flow rate G31 (g/h)	-	-	-	-
10	LPG G30/31 - 50 mbar	AUX	R	UR	UR*
	Rated heating capacity (kW)	1.1	3.1	3.3	6.0
	Nozzle diameter (1/100 mm)	42	76	76	102
	Reduced flow rate (W)	400	1100	1800	1900
	Primary air (mm)	1	1	1	2.5
	Rated flow rate G30 (g/h)	80	225	240	436
	Rated flow rate G31 (g/h)	79	221	236	429
11	Town gas G110 – 8 mbar	AUX	R	UR	UR*
	Rated heating capacity (kW)	1.1	3.0	3.3	3.8
	Nozzle diameter (1/100 mm)	132	250	250	310
	Reduced flow rate (W)	400	900	1400	1400
	Primary air (mm)	1	1	1.5	1.5
12	Town gas G120 – 8 mbar	AUX	R	UR	UR*
	Rated heating capacity (kW)	1.1	3.0	3.3	4.0
	Nozzle diameter (1/100 mm)	126	230	240	310
	Reduced flow rate (W)	400	900	1400	1400
	Primary air (mm)	1	1	1.5	1.5

The nozzles not provided are available at Authorised Service Centres.



Installation

5.6 Electrical connection



Power voltage Danger of electrocution

- Have the electrical connection performed by authorised technical personnel.
- Use personal protective equipment.
- The appliance must be connected to earth in compliance with electrical system safety standards.
- Disconnect the mains power supply.
- Do not pull the cable to remove the plug.
- Use cables withstanding a temperature of at least 90°C.
- The tightening torque of the screws of the terminal supply wires must be 1.5 - 2 Nm.
- **If it is necessary to replace the power cable, this must only be performed by a qualified technician.**

General information

Check the grid characteristics against the data indicated on the plate.

The identification plate bearing the technical data, serial number and brand name is visibly positioned on the appliance. Do not remove this plate for any reason. Perform the ground connection using a wire that is 20 mm longer than the other wires.

The appliance can work in the following modes:

65 - 75 cm models:

- **220-240 V 1N~ (default)**

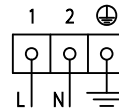

3 x 1.5 mm² three-core cable.



The values indicated above refer to the cross-section of the internal conductor.



90 cm models:

- **380-415 V 3N~ (default)**

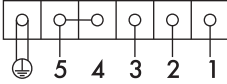

5 x 2.5 mm² five-core cable.

If the cable is replaced, the appliance can also function in the following modes:

* use the jumper provided

- **380-415 V 2N~ / 220-240 V 3~**

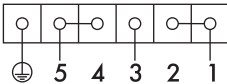

4 x 4 mm² four-core* cable.

- **220-240 V 1N~**

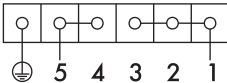

3 x 6 mm² three-core* cable.

The diagram below illustrates the power supply terminal from below, with no cables connected. Terminals **4** and **5** must be connected at all times.

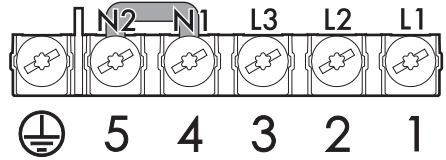

Fixed connection

Fit the power line with an omnipolar circuit breaker in compliance with installation regulations.

The circuit breaker should be located near the appliance and in an easily reachable position.



The values indicated above refer to the cross-section of the internal conductor.



Installation

Connection with plug and socket

Make sure that the plug and socket are of the same type.

Avoid using adapters and shunts as these could cause overheating and a risk of burns.



Run the power cable in the rear part of the unit. Take care to ensure that it does not come into contact with the lower part of the hob or any oven built-in underneath it.



Be careful when connecting additional electrical appliances. Connection cables must not come into contact with hot cooking zones.

Testing

At the end of installation, carry out a brief inspection test. If the hob fails to operate, after checking that you have carried out the instructions correctly, unplug the appliance and contact Technical Support.

5.7 Instructions for the installer

- The plug must be accessible after installation. Do not bend or trap the power cable.
- The appliance must be installed according to the installation diagrams.
- Do not try to unscrew or force the threaded elbow of the fitting. You may damage this part of the appliance, which may void the manufacturer's warranty.
- Use soap and water to check for gas leaks on all connections. **DO NOT** use naked flames to find leaks.
- Turn on all the burners separately and then all together to make sure that the gas valve, burner and ignition are working properly.
- Turn the burner knobs to the minimum position and check that the flame is stable for each individual burner and all the burners together.
- If the appliance does not work correctly after having carried out all the checks, contact your local Authorised Service Centre.
- Once the appliance has been installed, please explain to the user how to use it correctly.