

---

# **gorenje<sup>+</sup>**

**Instructions for use**

GDC67178F  
GSC27178F  
GDC67178FN





# Refrigerator freezer

Thank you for your confidence in buying our appliance and congratulations on the excellent choice. We hope it will successfully serve its purpose for many years.

**The appliance is intended solely for household use.**

**Refrigerator freezer** (hereinafter: the appliance) consists of two parts: the upper part is the refrigerator and the lower part is the freezer.

**The refrigerator** is intended for use in household for storing fresh food at temperatures above 0°C.

**The freezer** is intended for use in household to freeze fresh food and for long-term storage of frozen food (up to one year, depending on the type of food).

<b>Before first operation .....</b>	<b>4</b>
<b>A few tips on how to save power with your refrigerator-freezer combo .....</b>	<b>5</b>
<b>Appliance description .....</b>	<b>6</b>
<b>Installation and connections .....</b>	<b>7</b>
<b>Appliance with electronic control .....</b>	<b>8</b>
<b>Refrigerator interior equipment .....</b>	<b>13</b>
<b>Storage of food in the refrigerator .....</b>	<b>15</b>
<b>Storing food in the Fresh+ compartment .....</b>	<b>16</b>
<b>Freezing and storing frozen food .....</b>	<b>17</b>
<b>Defrosting the appliance .....</b>	<b>18</b>
<b>Cleaning the appliance .....</b>	<b>20</b>
<b>Troubleshooting guide .....</b>	<b>20</b>
<b>Noise level .....</b>	<b>22</b>

## Before first operation

- This appliance can be used by children aged from 8 years and above and persons with reduced physical, sensory or mental capabilities or lack of experience and knowledge if they have been given supervision or instruction concerning use of the appliance in a safe way and understand the hazards involved. Children shall not play with the appliance. Cleaning and user maintenance shall not be made by children without supervision.
- Before connecting the appliance read these instructions carefully. They describe the appliance and provide instructions for its safe and correct use. The instructions are prepared for different types and models of the appliance so they may contain descriptions of functions and components your appliance may not have.
- These instructions also contain the **No Frost+** version of the freezer, fitted with the fan and featuring automatic defrosting.
- Remove the wrapping protecting the appliance during transport.
- Wrappings contain environmentally friendly materials which can be recycled, recovered or disposed off without threat to the environment.
- On the door corners (on freestanding appliances) or on the housing of the appliances (on built-in appliances) the spacers are installed, which should be removed and replaced with the attached spacer-plugs.
- Before connecting the appliance to the mains supply, leave it in upright position for about 2 hours. This will reduce possibility of malfunctions in the cooling system resulting from prior transport and handling.
- The appliance must be connected to the mains supply in accordance with the standing regulations and local requirements.
- The appliance must not be used in open air or exposed to weather precipitation.
- Always disconnect the appliance from power supply (pull the power cord from wall socket) before cleaning and before replacing the light bulb.
- If the power supply cord is damaged, in order to avoid hazard it must be replaced by the service or by qualified personnel.
- In case of longer disuse first turn the appliance off with the ON/OFF button and disconnect it from mains supply. Empty the appliance, clean the interior and leave the door ajar.
- For the protection of environment deliver the obsolete appliance to the authorized scrap appliance dealers.
- Never let the children play with the appliance.
- Self closing shear door hinge pulls the door to the cabinet just before closing, thereby preventing the door to remain ajar. Equally it limits the door opening angle and prevents damage to adjacent elements.
- Rating plate with basic information is located in the interior of the appliance. If the sticker plate is not suitable for your language, replace it with the attached one.
- **Warning: Ventilation slots on the appliance or built-in element should always be kept clean and unobstructed.**

- **Warning:** Do not use any mechanical accessories when thawing the refrigerator, except for those explicitly recommended by the manufacturer.
- **Warning:** To prevent any pollution be careful not to damage the insulation or refrigeration tubes at the rear wall during the installation, cleaning and disposal of the appliance.
- **Warning:** Do not use any electrical devices inside the appliance, except for those explicitly recommended by the manufacturer.



The symbol on the product or on its packaging indicates that this product may not be treated as household waste. Instead it shall be handed over to the applicable collection point for the recycling of electrical and electronic equipment. By ensuring this product is disposed of correctly, you will help prevent potential negative consequences for the environment and human health, which could otherwise be caused by inappropriate waste handling of this product. For more detailed information about recycling of this product, please contact your local city office, your household waste disposal service or the shop where you purchased the product.

## A few tips on how to save power with your refrigerator-freezer combo

- Observe the installation instructions.
- Do not open the appliance door more frequently than necessary.
- Occasionally check whether air can circulate freely behind the appliance.
- Condenser unit mounted on the appliance back wall must be kept clean at all times (see section "Cleaning the appliance").
- If the seal is damaged or loose, replace it as soon as possible.
- Store your food in closed containers or other appropriate packaging.
- Before placing the food in the refrigerator, let it cool down to room temperature.
- Defrost your frozen food in the refrigerator compartment.
- Remove the freezer drawers and door as described in the instructions, in order to make use of the entire capacity.
- Defrost your conventional freezer when a frost layer approximately 3-5 millimetres thick has accumulated on the surfaces in the freezer compartment.
- Make sure the shelves are evenly distributed and that the food is arranged in a way that allows free circulation of air (heed the recommended food arrangement as described in the instructions).
- In appliances fitted with a fan, do not block the fan slots.

# Appliance description

Appliance interior equipment may change according to the appliance model.

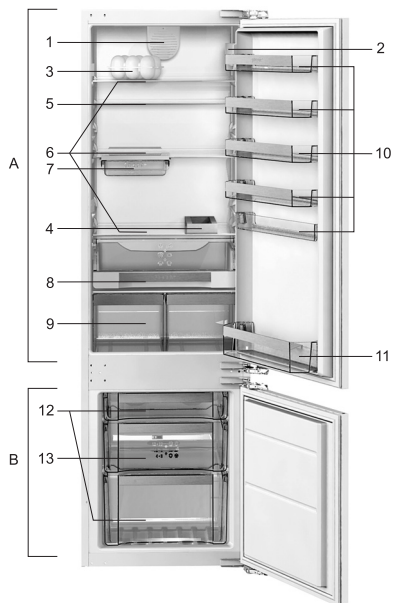
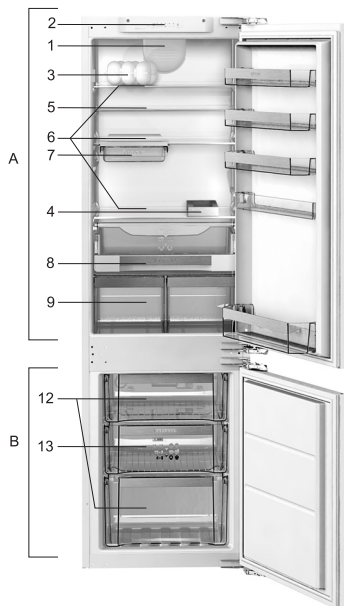

## **A Refrigerator**

1. Fan
2. Control unit
3. Folding egg tray (closed for 6, open for 12 eggs)
4. Bottle rack
5. Pull-out glass shelf – short
6. Pull-out glass shelf (height-adjustable)
7. **Snack+** pull-out drawer for snacks
8. **Fresh+** drawer
9. Fruit and vegetable bins
10. Refrigerator door bin (deep, shallow)
11. Bottle shelf with retainer

## **B Freezer**

12. Storage drawer
13. Freezing drawer

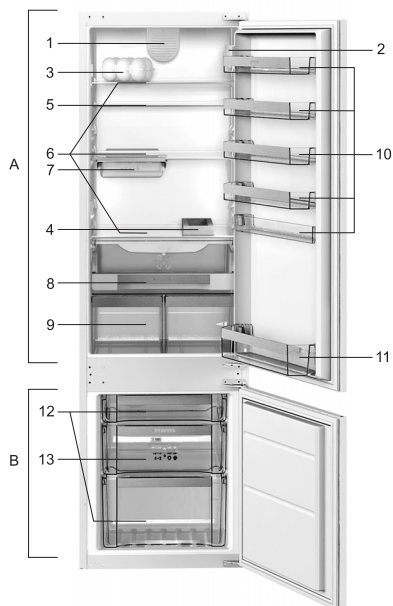

# Installation and connections

## Selecting the location

- Place the appliance in dry and well aired room. The appliance operates best at temperature ranges indicated in the chart below. Relevant class of the appliance is indicated on the rating plate.

Class	Ambient temperature
SN (subnormal)	from + 10°C to + 32°C
N (normal)	from + 16°C to + 32°C
ST (subtropical)	from + 16°C to + 38°C
T (tropical)	from + 16°C to + 43°C

## Positioning the appliance

Positioning the appliance requires two persons in order to avoid injuries or damage to the appliance.

- Place the appliance flatly and firmly on a solid base.
- Avoid exposing the appliance to direct sunlight or heat sources. If this is not feasible, install insulation plate between the appliance and adjacent heat source.
- Be sure to leave enough space for cooling of condenser (distance from the wall or the opening should be 200 cm<sup>2</sup>). Distance to the cabinet above the appliance should be at least 5 cm.  
After the installation, the appliance mains plug should be accessible!

**Warning:** when installing built-in appliances into a cupboard or cabinet in a side-by-side layout, the dew prevention installation kit should also be purchased and installed. **For safety reasons, dew prevention kit may only be installed by an authorized service technician!**

**Order code:** 376078 (appliances higher than 1,700 mm)

## Connecting to power supply

- Use the power cord to connect the appliance to the mains power. Wall outlet must be fitted with ground terminal (safety socket). Required nominal voltage and frequency are indicated on the relevant label or rating plate of the appliance.
- Mains power connection and grounding must be made in line with standing regulations and local requirements.

The appliance is able to accommodate minor temporary voltage tolerances, but they may not exceed -6% to +6%.

# Appliance with electronic control

## CONTROL UNIT I

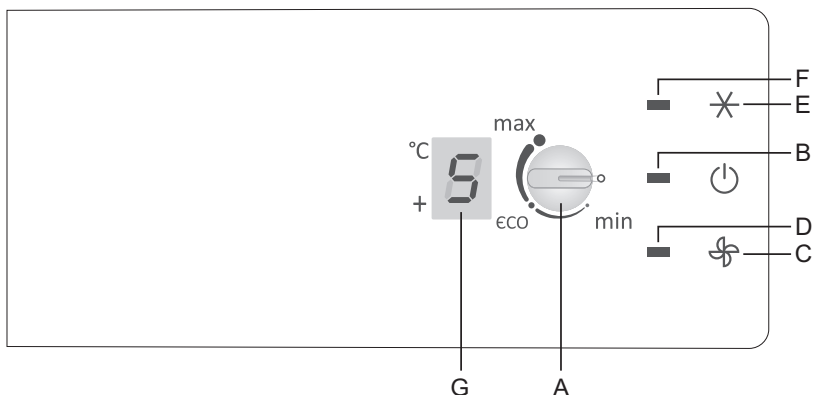

**A Temperature setting and on/off knob**

**B Signal light:** on when the appliance is in operation

**C Fan boost key**

**D Signal light:** on when the fan boost is activated

**E Super freeze key**

**F Signal light:** on when super freeze is activated

**G Digital refrigerator temperature display** indicates actual temperature in the appliance in the range from +1°C to +9°C

### Switching the appliance on/off

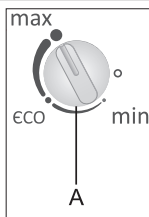

Switch on the appliance by rotating the **A** knob towards the **max.** position. To switch off the appliance, align the recess on the knob with the **o** sign (appliance is still powered - there is still electric current in the appliance).

### Setting the refrigerator temperature

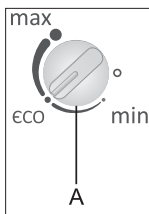

- Set the desired refrigerator temperature with the **A** knob. The temperature can be set in the range from **min.** to **max.**
- Recommended setting of the thermostat knob is on the **eco** position.
- If the temperature of the room in which the appliance is installed is lower than 16°C or if there is less than 10 kg of food in the freezer, we recommend setting the thermostat knob to **max.** position. The fan should be switched off. This is required in order to provide adequately low temperature in the freezer to allow long-term storage of frozen food.



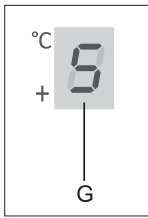

### Activating the fan boost



### Super freeze function

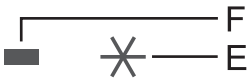

### Open refrigerator door alarm

- If the temperature in your home is higher than normal, we recommend activating the fan boost by pressing the **C** key.
- While the settings are being changed, the display will flash and an acoustic signal will indicate each change to the set temperature. When the flashing stops, the most recent setting is stored in the memory.
- When turning on the appliance, the display **G** will flash for a few seconds – to show the set value. Then, actual or maximum value is displayed. In case of the latter, it is displayed until the temperature in the refrigerator falls below that value.

- Press the **C** key to activate the fan boost (signal light **D** will light up). Use this function to reduce condensation (dew) on interior walls, temperature differences between particular sections of the appliance, or in case of higher environment temperature. The fan will only operate when the refrigerator door is closed.

- Use this setting after switching on the appliance for the first time, before cleaning, or when inserting a large amount of food. Press the **E** key (signal light **F** will light up). The setting will be switched off automatically after approximately two days.

If refrigerator door is open for more than one minute, an acoustic alarm will be activated. The alarm is deactivated when the door is closed.

## CONTROL UNIT II

### Appliance with a fan and the No Frost+ system

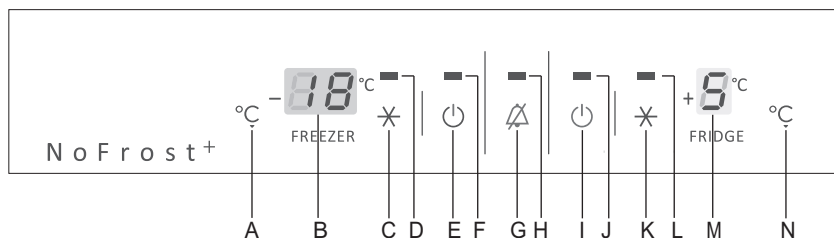

#### A Freezer temperature key

**B Freezer temperature digital display:** displays temperature in the range from  $-16^{\circ}\text{C}$  to  $-24^{\circ}\text{C}$

#### C Super freeze on/off key

**D Signal light:** on when super freeze is activated

#### E Appliance on/off key (refrigerator and freezer)

**F Signal light:** on when the freezer is operating

#### G Acoustic alarm acknowledgement and child lock on/off key

**H Signal light:** on when alarm is activated

#### I Refrigerator on/off key

**J Signal light:** on when the refrigerator is operating

#### K Extra cooling power on/off key

**L Signal light:** on when super extra cooling power is activated

**M Refrigerator temperature digital display:** displays temperature in the range from  $+1^{\circ}\text{C}$  to  $+9^{\circ}\text{C}$

#### N Refrigerator temperature key

### Switching the appliance on/off

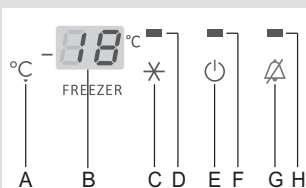

To switch on the appliance for the first time, connect the plug to a mains socket. The displays will indicate dashes to inform you that the refrigerator and the freezer are off.

- To switch on the appliance, press the **E** key and hold it for 3 seconds. Refrigerator and freezer will be switched on and the signal lights **F** and **J** will light up. In this mode, you may switch off the refrigerator only by pressing the **I** key and holding it for 3 seconds (signal light **J** will go off).

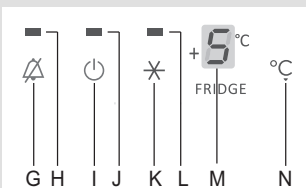

- Refrigerator temperature of  $+9^{\circ}\text{C}$  and freezer temperature of  $0^{\circ}\text{C}$  are displayed. These values will remain on respective displays until the temperature in each compartment falls below these values.
- The appliance is preset to the recommended refrigerator temperature of  $+5^{\circ}\text{C}$  and freezer temperature of  $-18^{\circ}\text{C}$ .

## Adjusting the temperature

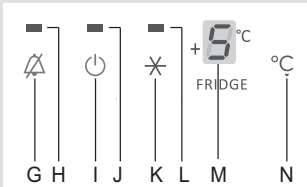
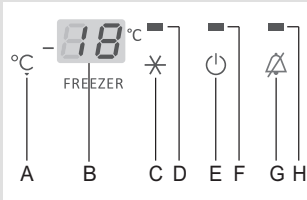

Refrigerator temperature range:	from +1°C to +9°
Freezer temperature range:	from -16°C to -24°C + super freeze

- Adjust the freezer temperature with the **A** key and refrigerator temperature with the **N** key.
- When one of the temperature adjustment keys is pressed, the display will start flashing and the most recent setting will be displayed.
- To adjust the temperature, briefly press the relevant key. Each time the key is pressed, the temperature is changed by 1°C. While the settings are being adjusted, all other keys are disabled.
- Approximately 5 seconds after releasing the key (inactivity), the most recently set temperature will be stored. Actual refrigerator or freezer temperature will be displayed.

## Other settings

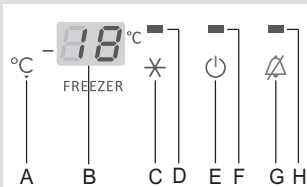

### Continuous acoustic signal - open refrigerator door alarm

If the refrigerator door is open for more than one minute, a continuous acoustic signal is activated and the signal light **H** will light up. The acoustic alarm will go off when the door is closed or when the alarm is acknowledged with the **G** key.

### Intermittent acoustic alarm - high refrigerator/freezer temperature alarm

When the temperature is too high, an intermittent acoustic signal will be activated and the temperature display will flash.

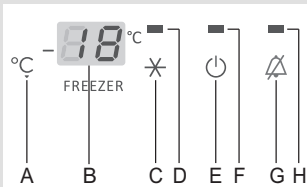

- Acknowledge the acoustic alarm by pressing the **G** key. As soon as the temperature in the freezer/refrigerator drops to a level that no longer represents food spoilage hazard, the signal light **H** will go off and the display will stop flashing.
- If 24 hours after acknowledging the alarm the temperature in the freezer is still not safe, the acoustic alarm will be reactivated. The alarm will go off automatically when the temperature drops to a level that no longer represents food spoilage. After the appliance is switched on for the first time, there is a 24-hour delay in alarm operation to prevent unnecessary activation.

### Intermittent acoustic signal - power failure alarm

If the temperature in the refrigerator or freezer rises too high as a result of a power failure, an intermittent acoustic signal will be activated, signal light **H** will light up, and the highest actual temperature will be indicated on a flashing display (for refrigerator, the maximum temperature is 9°C).

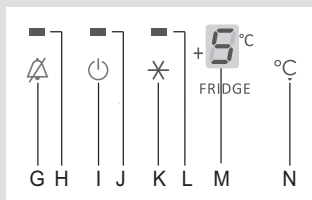

### Extra cooling power (refrigerator boost)

Press the **K** key to activate the extra cooling power (refrigerator boost). Signal light **L** will light up. In this case, the fan is operating as well, but only when refrigerator door is closed. After six hours, the function is deactivated and the settings will return to the most recent values. This function is intended for fast cooling of a large amount of food.

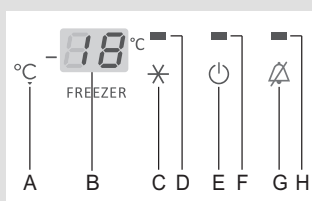

### Super freeze function

Press the **C** key to activate the super freeze function (freezer boost). Signal light **D** will light up. Super freeze will be activated.

If the function is not deactivated manually, the setting is switched off automatically approximately two days after activation. This function is intended **for fast freezing of a large amount of food**. In case of a power failure, the super freeze process is restarted. Use this setting after switching on the appliance for the first time, before cleaning, or when inserting a large amount of food.

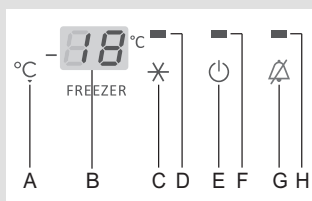

### Child lock

The built-in child lock prevents any inadvertent or unwanted changes to the settings/temperature or even switching the appliance off. Engage/disengage the lock by pressing the **G** key and holding it for 3 seconds ('LL' and 'L', respectively, will flash on the displays for 3 seconds). When the lock is engaged, only the child lock deactivation key is active. If any other key is pressed, the displays will read 'LL' and 'L', respectively.

# Refrigerator interior equipment

## Shelf

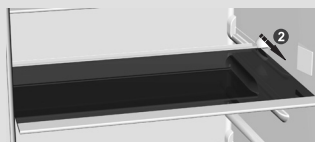

### (Equipment depends on the model)

- The shelves may be adjusted as you like using the guides in the refrigerator interior.
- Each shelf is fitted with a locking device at the back, which prevents it from being pulled out unintentionally. If you wish to pull out a shelf (to move to another position or for cleaning), please proceed as follows:
  1. lift the rear end of the shelf;
  2. pull out the shelf along the guides at the sides as far as the door;
  3. rotate the shelf upwards or downwards, depending on the position of the lighting device.

To replace the shelf, follow the procedure in reverse.

Store perishables at the back of the shelf where the temperature is lower.

## Bottle rack

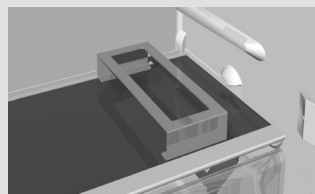

- Bottle rack can be placed on any shelf in the refrigerator. When placing the rack, make sure the bottles to not obstruct the door. The rack can be used elsewhere as well, e.g. as a convenient holder for bottled beverages stored at room temperature.

## Bin

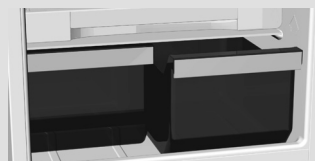

- The bin at the bottom of the refrigerator, under the glass shelf, is intended for storing fruit and vegetables. It provides humidity and prevents the food from drying out.

---

### ***Interior side of the refrigerator door***

---

### ***Fan***

---

### ***Snack+ pull-out drawer for snacks***



---

### ***Recommended food distribution in the appliance***

- Mounted on the refrigerator door are compartments (shelves or bins) intended for storing cheese, butter, eggs, yoghurt and other smaller packages, tubes, cans, etc. There is a bottle shelf at the lower end of the door.
- The fan is located under the ceiling or behind the back wall of the refrigerator compartment (or concealed in the freezer unit) to allow more even distribution of temperature and to reduce condensation on the storage area.
- This box with a special closing mechanism is ideal for storing food such as cheese, salami, bread spreads, pâté, sandwiches, butter, and other snacks. In this container, the food will not dry out; moreover, the box can be removed from the refrigerator and used to serve the food stored within. It is mounted under a glass shelf on a slider that allows moving it to the left or right as necessary to make the best use of the remaining space underneath.

#### **Sections in the refrigerator compartment:**

- **upper part:** canned food, bread, wine, pastry, etc.
- **middle part:** dairy products, ready-made meals, desserts, soft drinks, beer, cooked food, etc.
- **lower part:** meat, meat produce, delicatessen;
- **vegetable bin:** fresh fruit, vegetables, salads, etc.; root vegetables, potatoes, onions, garlic, tomatoes, tropical fruit, sauerkraut, turnips, etc.

#### **Sections in the refrigerator compartment door:**

- **upper/middle door shelf:** eggs, butter, cheese;
- **lower door shelf:** beverages, cans, bottles, etc.

#### **Freezer compartment sections:**

- freezing, storing frozen food (see Freezing and storing frozen food).

# Storage of food in the refrigerator

## ***Important precautions and hints***

- Proper use of the appliance, adequately packed food, correct temperature and hygienic precautions produce substantial impact on the quality of stored food.
- Always respect the best before date, printed on the packaging.
- Food to be stored in the refrigerator should be properly packed as to prevent emission and/or reception of moisture and odors.
- Never store inflammable, volatile or explosive substances.
- Beverages with high alcohol percentage shall be stored in tightly sealed bottles in vertical position.
- Some organic solutions like volatile oils in lemon or orange peel, acids in butter etc. can cause damage in prolonged contact with plastic surfaces or gaskets for longer period of time they can cause accelerated aging of the plastic material.
- Unpleasant odor inside the refrigerator is a sign that something is wrong with food or that your refrigerator needs cleaning (see chapter Cleaning).
- If you plan a longer absence, make sure you removed quickly perishable articles of food from the appliance before you leave.

## ***Storage periods***

### **Recommended periods of storing fresh food in the refrigerator**

<b>Food</b>	<b>Storage period</b>
eggs, marinades, smoked meat,	up to 10 days
cheese	up to 10 days
carrots, etc...	up to 8 days
butter	up to 7 days
cake, fruit, TV-dinner dishes, raw chunks of meat	up to 2 days
fish, raw minced meat, seafood	up to 1 day

## Storing food in the Fresh+ compartment

The **Fresh+** drawer allows storing a wide variety of fresh food to keep longer than in a conventional refrigerator. The food stays fresh longer, retaining the flavour and nutrients.

It slows down decay and loss of mass; therefore, fruit and vegetables remain fresh and natural longer.

For optimum performance, the drawer should be fully closed.

- When buying food, make sure it is fresh as this will determine the quality of the food, as well as how long it will keep in the fridge.
- Store your food in closed containers or appropriate packaging to prevent it from emitting or receiving odours and moisture.
- Take the food from the drawer 30-60 minutes before use to allow the aroma and flavour to develop at room temperature.
- Food sensitive to low temperature and not appropriate for storage in the **Fresh+** drawer include the following: pineapple, avocado, bananas, olives, potatoes, eggplant, cucumbers, beans, peppers (capsicum), melons, watermelons, pumpkins and squash, etc.

- To remove the drawer:
  - remove the vegetable bin;
  - remove the glass shelf above and, with some models, under the FRESH ZONE drawer;
  - if necessary (with some models), remove the drawer door (1): open, hold in the middle (as shown in the figure), bend slightly and simultaneously pull up towards you;
  - pull out the drawer to the position indicated in the figure (detail "A"), rotate it downwards and remove it.
  - To replace the drawer, observe the reverse order.

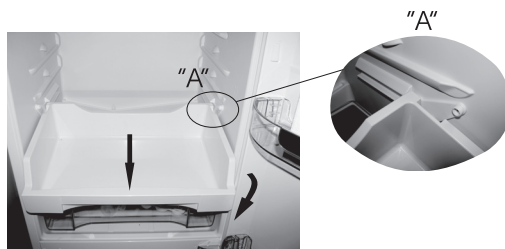



# Freezing and storing frozen food

## Freezing process

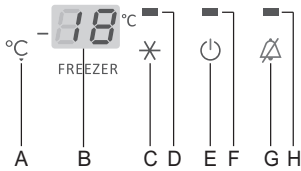

## Important precautions and hints for freezing fresh food

- 24 hours before freezing fresh food, activate the super freeze function:
  - control unit I: use the **E** key,
  - control unit II: use the **C** key.

After 24 hours of super freeze operation, insert the fresh food into the freezer compartment.

Make sure the fresh food does not come into contact with the food that is already frozen!

In **No Frost+** freezers, sufficient clearance should be left under the ceiling to allow circulation of cool air. Therefore, do not load the food higher than the indicated mark (see figure).

- After 24 hours you may relocate the food **to the storage compartment**, and repeat the freezing procedure if required. You may also remove the drawers and store frozen food directly on cooling shelves. Do not remove the lower drawer if you have a NO FROST appliance!
- For freezing smaller quantities of fresh food (1-2 kg), the engagement of the fast freeze function is not required.
- Freeze only such food which is suitable for freezing and sustain low temperatures. Food should be of adequate quality and fresh.
- Select adequate packaging for each kind of food and pack it correctly.
- The packaging should be air tight and well sealed without leaking since this could cause substantial vitamin loss and dehydration.
- Mark packages with following data: kind and amount of foods and the date of loading.
- It is imperative that food is frozen as quickly as possible. We therefore recommend the size of the package not to be too large and to be cooled before loading into the freezer.
- The amount of the fresh foods that can be loaded in the freezer as a single load is declared on the rating plate. If the loaded amount is too large, the quality of freezing is reduced which in turn affects the quality of frozen foods.

## **Storage of industrially frozen food**

The storage time and recommended temperature for storing commercially frozen foods is indicated on the packaging. Always follow manufacturer's instructions for storage and use of frozen food. When shopping be careful to choose only food which is adequately packed and provided with complete data and stored in freezers where the temperature never rises above -18°C. Do not buy packages of food wrapped with frost. This indicates that the package was thawed before at least once. Take care that packages don't start to thaw during transport to your home. Temperature rise shortens the storage time and affects the quality of commercially frozen foods.

## **Storage periods of frozen food**

### **Recommended periods of storing frozen food in the freezer**

<b>Food</b>	<b>Period</b>
Fruit, beef	from 10 to 12 months
Vegetables, veal, poultry	from 8 to 10 months
Venison	from 6 to 8 months
Pork	from 4 to 6 months
Chopped (minced ) meat	4 months
Bread, pastry, TV-dinners, fat free fish	3 months
Intestines	2 months
Smoked sausages, fat fish	1 month

## **Defrosting frozen food**

Partially thawed or defrosted foods should be used as soon as possible. Cold air preserves the food but it does not destroy microorganisms which rapidly activate themselves after defrosting and make foods perishable. Partial defrosting reduces the nutritional value of food, especially fruits, vegetables and readymade meals.

## **Defrosting the appliance**

### **Automatic defrosting of the refrigerator**

Refrigerator needs no special defrosting procedure, because ice deposited at the inner back wall is defrosted automatically. Ice deposited on the inner back wall during the compressor operation is defrosted when the compressor stops operating, and condensed water drops are drained through the outlet in the inner back wall into the drain pan situated above the compressor where it evaporates. In case you should notice excessive ice formation at the rear refrigerator panel (3-5 mm thick), switch the appliance off and thaw it manually.

---

### ***Defrosting classical freezer***

- Clean the freezer when the frost layer in the freezer reaches thickness of around 3-5 mm.
- 24 hours before defrosting activate the fast freeze function (see relevant control chapter depending upon the model of the appliance – fast freezing) for continuous operation in order to additionally freeze the food inside. After that period take the food out of the freezer and protect them from excessive thawing.
- Switch the appliance off (see the relevant control chapter for ON/OFF function) and pull the power cord from the wall socket.
- Place a convenient absorbent cloth underneath to collect the defrost water and change it periodically.
- Never use powered appliances to defrost the freezer (hair dryer, etc.) - **LIFE THREATENING!**
- Avoid using defrosting sprays, as they may cause damage to the plastic parts and may be hazardous to health.
- Clean the interior of the appliance and wipe it dry (see chapter Cleaning).
- Before reloading food into the freezer switch the appliance on.

---

### ***Defrosting the No Frost+ freezer***

- The **No Frost+** freezer will defrost automatically. Occasional frost that may appear on the walls will disappear automatically.
- Build-up of ice or frost in the freezer compartment can be a result of abnormal use of appliance (door opened too frequently and/or too long, door not properly closed etc.). In this case, unplug the appliance, remove the food from the freezer and protect them from defrosting. Clean and dry the freezer interior. Before returning the frozen food into the freezer, switch on the appliance and select the desired setting.

## Cleaning the appliance

**Prior any cleaning attempt disconnect the appliance from the mains** (see the control chapter for ON/OFF function), and pull the power cord from the mains wall outlet.

Make sure to remove traces of any cleansing agents you had been using.

- Clean the **exterior** of the appliance with water and liquid detergent.
- Do not use abrasive or aggressive agents (such as stainless steel cleansers) for cleaning of plastic and coated surfaces as you can damage them.
- Clean **coated and/or aluminum surfaces** with soft cloth and alcohol based cleansing agent (for example glass cleaners).
- Wash the **interior** of the appliance with liquid detergent and lukewarm water, mixed with a little vinegar.
- Containers, shelves, and drawers with a decorative profile (metallic appearance) are not dishwasher safe! They can only be cleaned with a dissolved liquid detergent and a soft cloth. Do not rub them!
- Groove and drain outlet located underneath the cooling panel at the rear wall collect the drained water, so they must not be clogged (with food particles, for example). Make sure you inspect them periodically and clean if necessary (use plastic straw to free the outlet hole).

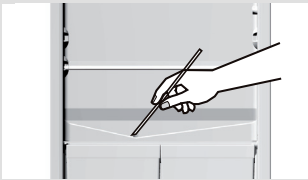

## Troubleshooting guide

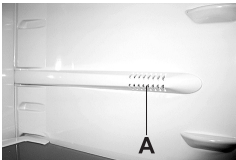
Fault:	Cause/Remedy
The appliance does not operate after connection to the mains:	<ul style="list-style-type: none"> <li>• Check if there is power in the socket and if the appliance is switched on.</li> </ul>
Cooling system operates continuously without intermittent stoppages: 	<ul style="list-style-type: none"> <li>• Ambient temperature too high.</li> <li>• Frequent opening of the door, door open too long.</li> <li>• Door not closed properly (particle between door gasket, sagged door, check gasket sealing, etc...).</li> <li>• Excessive quantity of fresh food inserted at once.</li> <li>• Refrigerator probe (A) is clogged with fresh food. Relocate the food to provide air circulation around the probe (certain models only).</li> <li>• Check air circulation for sufficient cooling of the compressor, and clean the condenser.</li> </ul>

Fault:	Cause/Remedy
Excessive ice formation at the rear interior wall of the freezer:	<ul style="list-style-type: none"> <li>• Frequent opening of the door, door open too long.</li> <li>• Inserting hot food in the freezer.</li> <li>• Food or dish is touching the rear interior panel of the refrigerator.</li> <li>• Bad door sealing; clean or replace the gasket if dirty or damaged.</li> </ul>
Build-up of ice or frost in the freezer interior may be a result of the following:	<ul style="list-style-type: none"> <li>• Door opened too frequently or too long.</li> <li>• Door not properly closed.</li> <li>• Poor door sealing.</li> <li>• If the seal is dirty or damaged, clean or replace it.</li> </ul>
Water dripping from the appliance:	<ul style="list-style-type: none"> <li>• Drain outlet is clogged, drain water drips past the collection groove.</li> <li>• Clean the clogged outlet using plastic straw.</li> <li>• Thaw thick ice deposits manually (see chapter Defrosting).</li> </ul>
Flashing signal light <b>H</b> : (only freezer)	<ul style="list-style-type: none"> <li>• Frequent opening of the door, door open too long.</li> <li>• Door not closed properly (particle between door gasket, sagged door, damaged gasket, etc...).</li> <li>• Excessively long power failure.</li> <li>• Excessive quantity of fresh food inserted at once.</li> </ul>
Difficult door opening:	<ul style="list-style-type: none"> <li>• If you attempt to open the immediately closed door of the freezer you may experience resistance. This happens because certain quantity of cold air escapes from the appliance through the open door and is replaced by warm ambient air. Cooling of such air creates negative pressure (vacuum) and suction, which prevents easy opening of the door. Situation is normalized after a few minutes (5-10), and you can open the door with ease.</li> </ul>
LED lighting does not work: 	<ul style="list-style-type: none"> <li>• If the LED lighting no longer works, call an authorized Gorenje service technician.</li> </ul>
Signal light <b>B</b> is flashing:	<ul style="list-style-type: none"> <li>• If the signal light <b>B</b> is flashing, call a service technician.</li> </ul>
Error code displayed (certain models only):	<ul style="list-style-type: none"> <li>• If the character <b>E</b> appears on the digital display (certain models only), call service assistance.</li> </ul>

If none of the above reasons seems to match your problem, please contact the nearest service center and state the type, model and serial number as indicated on the label with basic information attached in the appliance interior.

The refrigerator – freezer appliances are cooled by the refrigeration system with a compressor (assisted by fan in certain models) whose operation may produce certain noise. The level of such noise depends upon the location, correct use and age of the appliance.

- **After starting the appliance**, the operation of the compressor (the refrigerant flow) may be somewhat louder. This does not mean that something is wrong with the appliance, neither has it any influence on the lifetime of the appliance. Gradually the noise is reduced and eventually subsides.
- Sometimes the appliance produces **unusual and stronger noise** which is rather unusual for the appliance. This noise is often the consequence of inadequate positioning of the appliance:
  - The appliance should be placed and leveled firmly on solid base.
  - It should not touch the wall or adjacent kitchen units standing next to it.
  - Check whether the accessories in the interior of the appliance are placed correctly in their positions; also check the bottles, tins and other vessels that might touch each other and rattle.

THE MANUFACTURER RESERVES THE RIGHT TO ALTER THE SPECIFICATIONS WITH NO IMPACT TO THE FUNCTIONAL OPERATION OF THE APPLIANCE.

Instructions for use of the appliance can also be found on our website at [www.gorenje.com](http://www.gorenje.com) / < <http://www.gorenje.com> / >



---

**gorenje<sup>+</sup>**



476455