

**MT** **IE** **GB**

# Instructions for use, installation, and connection

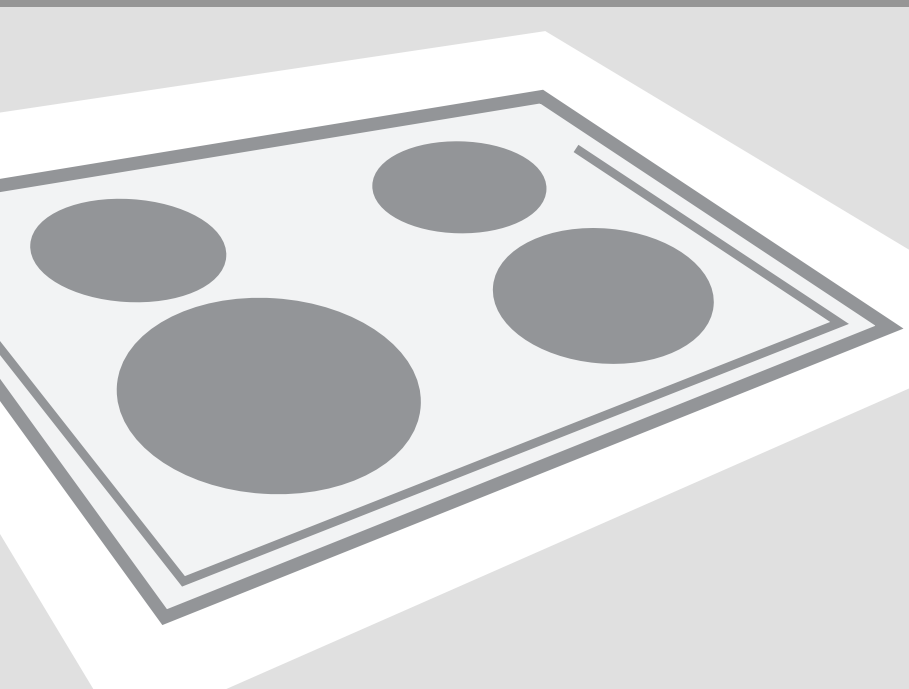

Your induction hob

---

# CONTENTS

---

## ***Your induction hob***

Introduction	3
Control panel SIVK6GTS	4
Control panel SIVK6ETS	5
Description	6

## ***Safety instructions***

What you should pay attention to	7
Connection and repair	7
During use	7
Temperature safety	9
Cooking-time limiter	9

## ***Use***

Using the touch controls	10
Induction cooking	10
How does induction work	11
Pans	11

## ***Operation***

Switching on the hob and setting the power	13
Switching off the hob	13
Pan detection	14
Residual warmth indicator	14
Boost	14
Automatic heat-up function	14
Two cooking zones behind each other	15
Bridge mode	16
Keeping food warm	17
Child lock	17
Cooking timer/Egg timer	18

## ***Cooking***

Healthy cooking	20
Cooking settings	20

## ***Maintenance***

Cleaning	22
----------	----

## ***Faults***

General	23
Troubleshooting table	23

## ***Installation***

What you need to consider	25
Ventilation	27
Lower kitchen cabinet with a drawer	27
Lower kitchen cabinet with an oven	28
Electrical connection	29
Building in	31
Technical details	32

## ***Environmental aspects***

Disposal of packaging and appliance	33
-------------------------------------	----

# YOUR INDUCTION HOB

---

## ***Introduction***

---

This hob has been designed for the real lover of cooking. Cooking with an induction hob has a number of advantages. It is easy, because the hob reacts quickly and can also be set to a very low power level. Because, moreover, it can also be set to a high power level, it can bring dishes to the boil very quickly. The ample space between the cooking zones makes cooking comfortable.

Cooking on an induction hob is different from cooking on a traditional appliance. Induction cooking makes use of a magnetic field to generate heat. This means that you cannot use just any pan on it. The pans section gives more information about this.

For optimum safety the induction hob is equipped with several temperature protections and a residual heat indicator, which shows which cooking zones are still hot.

The hob has four slider areas to adjust the power level of the cooking zones. With a special bridge button you can connect (bridge) two zones behind each other. Both zones will have the same settings after activating this function.

This manual describes how you can make the best possible use of the induction hob. In addition to information about operation, you will also find background information that can assist you in using this product. You will also find cooking tables and maintenance tips.

**Read the manual thoroughly before using the appliance, and store these instructions in a safe place for future reference.**

The manual also serves as reference material for service technicians. Please, therefore, stick the appliance identification card in the space provided, at the back of the manual. The appliance identification card contains all the information that the service technician will need in order to respond appropriately to your needs and questions.

Enjoy your cooking!

# YOUR INDUCTION HOB

## Control panel SIVK6GTS

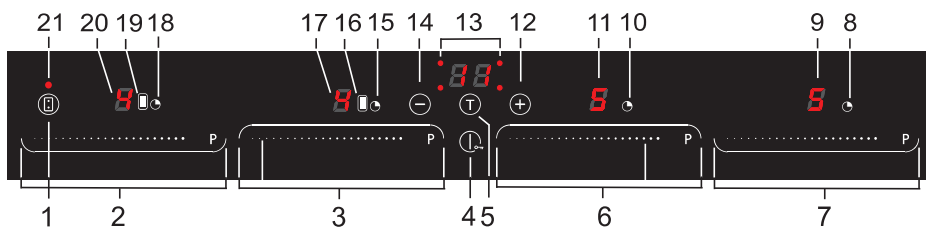

1. Bridge button for cooking zones left
2. Multi slider cooking zone front left
3. Multi slider cooking zone rear left
4. On/Off button with lock mode indicator
5. Timer button
6. Multi slider cooking zone rear right
7. Multi slider cooking zone front right
8. Timer indicator cooking zone front right
9. Cooking level cooking zone front right
10. Timer indicator cooking zone rear right
11. Cooking level cooking zone rear right
12. + button timer
13. Timer display with four timer indicators
14. - button timer
15. Timer indicator cooking zone rear left
16. Bridge indicator cooking zone rear left
17. Cooking level cooking zone rear left
18. Timer indicator cooking zone front left
19. Bridge indicator cooking zone front left
20. Cooking level cooking zone front left
21. Bridge indicator for cooking zones left

# YOUR INDUCTION HOB

## Control panel SIVK6ETS

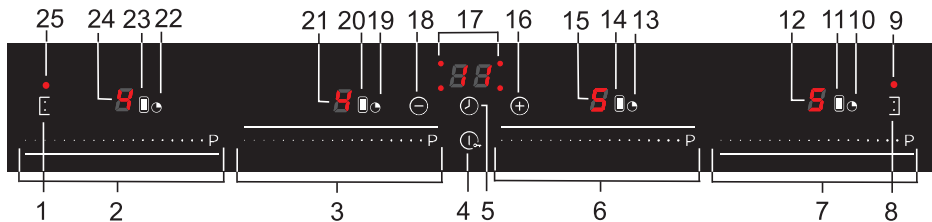

1. Bridge button for cooking zones left
2. Multi slider cooking zone front left
3. Multi slider cooking zone rear left
4. On/Off button with lock mode indicator
5. Timer button
6. Multi slider cooking zone rear right
7. Multi slider cooking zone front right
8. Bridge button for cooking zones right
9. Bridge indicator for cooking zones right
10. Timer indicator cooking zone front right
11. Bridge indicator cooking zone front right
12. Cooking level cooking zone front right
13. Timer indicator cooking zone rear right
14. Bridge indicator cooking zone rear right
15. Cooking level cooking zone rear right
16. + button timer
17. Timer display with four timer indicators
18. - button timer
19. Timer indicator cooking zone rear left
20. Bridge indicator cooking zone rear left
21. Cooking level cooking zone rear left
22. Timer indicator cooking zone front left
23. Bridge indicator cooking zone front left
24. Cooking level cooking zone front left
25. Bridge indicator for cooking zones left

# YOUR INDUCTION HOB

## Description

### SIVK6GTS

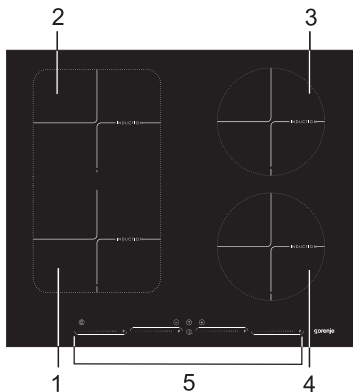

1. Cooking zone front left  
octa 180 mm x 220 mm 3,7 kW
2. Cooking zone rear left  
octa 180 mm x 220 mm 3,7 kW
3. Cooking zone rear right Ø180 3,0 kW
4. Cooking zone front right Ø180 3,0 kW
5. Control panel

### SIVK6ETS

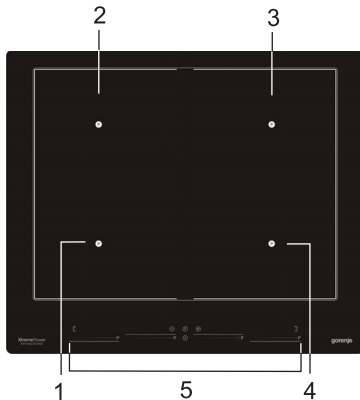

1. Cooking zone front left  
octa 180 mm x 220 mm 3,7 kW
2. Cooking zone rear left  
octa 180 mm x 220 mm 3,7 kW
3. Cooking zone rear right  
octa 180 mm x 220 mm 3,7 kW
4. Cooking zone front right  
octa 180 mm x 220 mm 3,7 kW
5. Control panel

# SAFETY INSTRUCTIONS

---

## ***What you should pay attention to***

---



- Induction cooking is extremely safe. Various safety devices have been incorporated in the hob such as a residual heat indicator and a cooking time limiter. There are nevertheless a number of precautions you should take.

## ***Connection and repair***

---



- This appliance may only be connected by a qualified installer.
- Never open the casing. The casing may only be opened by the service technician.
- Disconnect the electricity from the appliance before starting any repair work. Preferably unplug the appliance, switch the (automatic) fuse(s) off or, in the event of a permanent connection, set the switch in the power supply lead to zero.

## ***During use***

---



- Do not use the hob in temperatures below 5 °C.
- This cooking appliance is designed for household use. It is to be used for food preparation only.
- When you use the hob for the first time you will notice a “new smell”. This is normal. If the kitchen is well ventilated the smell will soon disappear.
- Remember that if the hob is used on a high setting the heating time will be incredibly short. Do not leave the hob unattended if you are using a zone on a high setting.
- Ensure there is adequate ventilation while the hob is in use. Keep all natural ventilation openings open.
- Do not allow pans to boil dry. The hob itself is protected against overheating but the pan will get very hot indeed and could be damaged. The guarantee does not cover any damage caused by a pan boiling dry.
- Do not use the cooking area as storage space.
- Ensure that there is several centimetres clearance between the hob and the contents of the drawer.
- Do not keep anything combustible in the drawer under the hob.
- Make sure that flexes of electrical appliances, such as a mixer, cannot touch the hot cooking zone.

## SAFETY INSTRUCTIONS



- The zones heat up during use and stay hot for a while afterwards. Keep young children away from the hob during and immediately after cooking.
- Never let children play with this device. Children are not to be allowed near the device unsupervised.
- Grease and oil are inflammable when overheated. Do not stand too close to the pan. Should oil catch fire, never try to extinguish the fire with water. Put a lid on the pan immediately and switch the cooking zone off.
- Never flambé food under the cooker hood. The high flames could cause a fire, even if the cooker hood is switched off.
- The ceramic top is extremely strong, but not unbreakable. A spice jar or pointed utensil falling on it, for example, could cause it to break.
- Stop using the hob if a break or crack appears. Switch the appliance off immediately, unplug it to avoid electric shocks, and call the service department.
- Never put any metal objects such as baking trays, biscuit tins, saucepan lids or cutlery on the cooking zone. These can heat up extremely quickly and cause burns.
- Keep magnetizable objects (credit cards, bank cards, etc.) away from the appliance. We advise anyone with a pacemaker to consult their cardiologist before using an induction hob.
- Never use a pressure cleaner or steam cleaner to clean the hob.
- This appliance is not intended for use by persons (including children) with reduced physical, sensory or mental capabilities, or lack of experience and knowledge, unless they have been given supervision or instruction concerning use of the appliance by a person responsible for their safety.
- As soon as you remove the pan from the hob, the cooking zone automatically stops. Accustom yourself to stop the cooking zone or hob manually to avoid unintended switching on of the induction hob.
- Never let an empty pan stand on a hotplate that is switched on. While the hotplate is protected and will switch itself off, the pan will be extremely hot. The pan could be damaged.
- A small object like a pan that is too small (diameter of bottom smaller than 12 cm), a fork or a knife will not be recognised by the appliance. The display continues to flash and the hob will not switch on.



# SAFETY INSTRUCTIONS

- The appliance is not intended to be operated by means of an external timer or separate remote-control system.
- If the connecting cable is damaged, it may only be replaced by the manufacturer, the manufacturer's service organisation or equivalently qualified persons, in order to avoid dangerous situations.

## Temperature safety

- A sensor continuously measures the temperature of certain parts of the hob. Every cooking zone is equipped with a sensor that measures the temperature of the bottom of the pan to avoid any risk of overheating when a pan boils dry. In case of temperatures rising too high, the power is reduced automatically.

## Cooking-time limiter



- The cooking-time limiter is a safety function of your cooking appliance. It will operate if you forget to switch off your hob.
- Depending on the setting you have chosen, the cooking time will be limited as follows:

Setting	The cooking zone switches automatically off after:
1	8,5 hours
2	6,5 hours
3	5 hours
4	4 hours
5	3,5 hours
6	3 hours
7	2,5 hours
8	2 hours
9	1,5 hours
u	2 hours

The cooking-time limiter switches the cooking zones off if the time in the table has elapsed.

Setting	The cooking zone switches automatically to setting 9 after:
boost (P)	10 minutes

## Using the touch controls

The touch controls may take some getting used to if you are used to other (rotary) controls. Place the tip of your finger flat on the control to achieve the best results. You do not have to apply any pressure.

The touch sensors only react to the light pressure of a fingertip. Do not operate the controls with any other objects. The hob will not switch on when your pet walks over it.

## Induction cooking

### **Induction cooking is fast**

- To start you will be surprised by the speed of induction cooking. Especially at higher settings, foods and liquids will boil very rapidly. It is best not to leave pans unattended to avoid them boiling over or boiling dry.

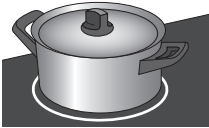

No heat loss and cold handles with induction cooking.

### **The power will be adjusted**

- In the case of induction cooking, it is only the part of the zone on which the pan stands that is used. If you use a small pan on a large zone, the power will be adjusted to the diameter of the pan. The power will thus be lower and it will take longer before the food in the pan comes to the boil.

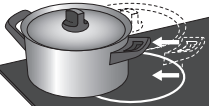
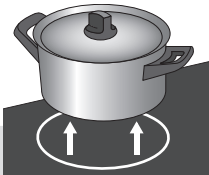

### **Attention**

- Grains of sand may cause scratches which cannot be removed. Only put pans with a clean base on the cooking surface and always pick pans up to move them.
- Do not use the hob as a worktop. Always keep the lid on the pan when cooking, in order to avoid energy loss.

## How does induction work

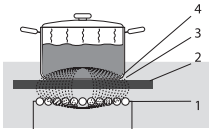

The coil (1) in the hob (2) generates a magnetic field (3). By placing a pan with an iron base (4) on the coil, a current is induced in the base of the pan.

A magnetic field is generated in the appliance. By placing a pan with an iron base on a cooking zone, a current is induced in the pan base. This induced current generates heat in the base of the pan.

### Easy

The electronic controls are accurate and easy to set. On the lowest setting, you can melt chocolate directly in the pan, for example, or cook ingredients that you would normally heat in a bain-marie.

### Fast

Thanks to the induction hob's high power levels, bringing food to the boil is very quick. Cooking food through takes just as long as for other types of cooking.

### Clean

The hob is easy to clean. Because the cooking zones do not get any hotter than the pans themselves, food spills cannot burn on.

### Safe

The heat is generated in the pan itself. The glass top does not get any warmer than the pan. This means that the cooking zone is considerably cooler compared to that from a Ceramic hob or a gasburner. Once a pan has been taken away, the cooking zone cools down quickly.

## Pans



### Pans for induction cooking

Induction cooking requires a particular quality of pan.

#### Attention

- Only use pans that are suitable for electric and induction cooking with:
  - a thick base (minimum 2.25 mm)
  - a flat base.
- The best are pans with the 'Class Induction' quality mark.



## Tip

You can check for yourself whether your pans are suitable using a magnet. A pan is suitable if the base of the pan is attracted by the magnet.

Suitable	Unsuitable
Special stainless steel pans	Earthenware
Class Induction	Stainless steel
Hard-wearing enamelled pans	Porcelain
Enamelled cast-iron pans	Copper
	Plastic
	Aluminium



## Attention

Be careful with enamelled sheet-steel pans:

- the enamel may chip (the enamel comes loose from the steel), if you switch the hob on at a high setting when the pan is (too) dry;
- the base of the pan may warp - due, for example, to overheating or to the use of too high a power level.



## Attention

Never use pans with a misshapen base. A hollow or rounded base can interfere with the operation of the overheating protection, so that the appliance becomes too hot. This may lead to the glass top cracking and the pan base melting. Damage arising from the use of unsuitable pans or from boiling dry is excluded from the guarantee.

## Minimum pan diameter

The diameter of a pan must be at least 12 cm. For best results, use cookware with diameter that matches the diameter of the cooking zone, and place it in the middle of the cooking zone.

Warning: In model SIVK6ETS, always place the cookware in such way that the indicated center of the cooking zone is covered.

## Pressure cookers

Induction cooking is very suitable for cooking in pressure cookers. The cooking zone reacts very quickly, and so the pressure cooker is quickly up to pressure. As soon as you switch a cooking zone off, the cooking process stops immediately.

## **Switching on the hob and setting the power**

The power has 9 settings. There is also a 'boost' setting, which is indicated by a 'P.' in the display (see page 14 'Boost').



- Put a pan on a cooking zone (In model SIVK6ETS, always place the cookware in such way that the indicated center of the cooking zone is covered.).
- Touch the On/Off button.  
*You will hear a short bleep and the display for each cooking zone will show '0.'. If no further action is taken, the hob automatically switches off after 10 seconds.*
- Touch and slide your finger over the multi slider of the desired cooking zone to choose the correct setting. The hob will automatically start in the chosen setting (if it detects a pan).
  - Sliding to the right increases the value and sliding to the left decreases the value.
  - A direct selection of a value is also possible. Touch the multi slider somewhere in the slider area to set a power level.

## **Switching off the hob**

### **Switching off one cooking zone**

*A cooking zone is switched on. The display shows a power setting between 1 and 9, or 'P.'.*

- Touch and slide your finger (to the left) over the multi slider of the desired cooking zone to level '0.'.  
Or:
- Directly select setting '0.' by touching the left side of the multi slider of the desired cooking zone.  
*You will hear a bleep and the display will show '0.'. If all of the cooking zones are set to '0.' and if no further action is taken, the hob automatically switches off after 10 seconds.*

### **Switching off all of the cooking zones at the same time**

*Several cooking zones are active.*

- Briefly touch the On/Off button to switch off all of the cooking zones at the same time.  
*You will hear a single bleep. No lights are illuminated. The hob is now switched off.*

## **Pan detection**



If the hob does not detect a (ferrous) pan after the cooking power has been set, the pan detection symbol and the selected power setting will flash alternately in the display and the hob will remain cold. If a (ferrous) pan is not placed on the cooking zone within 1 minute, the cooking zone will automatically switch off (see also page 11 and 12 'Pans').

## **Residual warmth indicator**



A cooking zone that has been used intensively will retain heat for several minutes after it has been switched off. An 'H.' appears in the display as long as the cooking zone is hot.

## **Boost**



The 'Boost' function is used to cook at maximum power for a short period of time (maximum 10 minutes). The power is reduced to setting 9 at the end of the maximum boost time.

**Boost function is not available in bridge mode!**

### **Switching on the boost function**

*The hob is switched on and a pan is on a cooking zone.*

- Touch and slide your finger (to the right) over the multi slider of the desired cooking zone to choose setting 'P'. (You can also use the multi slider if the power has already been set).

Or:

- Directly select setting boost by touching 'P' on the multi slider.  
*The display shows 'P.'. The boost function is immediately active.*

### **Switching off the boost function**

*The boost function is switched on, the display shows 'P.'.*

- Touch and slide your finger (to the left) over the multi slider of the desired cooking zone to set a lower level.

Or:

- Directly select a lower setting by touching the left side of the multi slider of the desired cooking zone.

## **Automatic heat-up function**

The automatic heat-up function temporarily increases the power (setting '9.') to heat the contents of the pan. This function is available in settings 1-8.



## Switching on the automatic heat-up function

*The hob is switched on and a pan is on a cooking zone.*

- Touch and slide your finger over the multi slider of the desired cooking zone to choose the correct setting and hold down your finger on that setting for 3 seconds.

*'A.' and the correct setting flash alternately in the display, the automatic heat-up function is active.*

- ▶ If you select a lower cooking stage, the automatic heat-up function is switched off.
- ▶ If you select a higher cooking stage, the duration of the heating-up will automatically be brought in line with the new cooking stage.
- As soon as the automatic heat-up time is over, the automatic heat-up function automatically switches off and the cooking zone continues at the set power.

The table below shows the duration of the automatic heat-up function for each power setting:

Setting	1	2	3	4	5	6	7	8
Seconds	40	72	120	176	256	432	120	192

## Switching off the automatic heat-up function

*The hob is switched on. 'A.' and the power setting flash alternately in the display.*

- Touch and slide your finger (to the left) over the multi slider of the desired cooking zone to set a lower level.

Or:

- Directly select a lower setting by touching the left side of the multi slider of the desired cooking zone.

*A different power setting is shown in the display and 'A.' stops flashing.*

## Two cooking zones behind each other

- Two cooking zones that are behind each other influence each other. The power is automatically distributed when these cooking zones are used at the same time. This does not have any consequences up to setting 9. Selecting the Boost setting for one of the cooking zones, however, automatically switches the other cooking zone to a lower setting.
- If one of the cooking zones is set to boost and you want to set the other zone to setting 9 or Boost, the cooking zone that is set to

boost will automatically be switched to a lower setting.

- Two cooking zones that are beside each other do not influence each other. You can set both cooking zones to Boost.

## Bridge mode

The bridge mode can be activated by pressing the bridge button. Both zones on the left (and the right side; only for SIVK6ETS) will have the same settings after activating this function. The displays and keys of the section of the most rear zones will not work. Changing the settings is only possible with the multi slider of the zones in the front. When the timer is active, the timer indicators in the timer display will illuminate for both bridged zones at the same time.

### Activating the bridge mode

- Put a pan (or two/three pans) on the cooking zones that you want to set to the bridge mode. (In model SIVK6ETS, always place the cookware in such way that the indicated center of the cooking zone is covered.)
- Touch the On/Off button.  
*You will hear a short bleep and the display for each cooking zone will show '0'. If no further action is taken, the hob automatically switches off after 10 seconds.*
- Press the bridge button on the left (or on the right; only for SIVK6ETS).  
*The bridge indicator will illuminated and you will see a bridge symbol in the display.*
- Touch and slide your finger over the multi slider of the bridged cooking zone to choose the correct setting. The hob will automatically start in the chosen setting (if it detects a pan).
  - You can link the bridged zone to a timer; in this case you will also see a timer symbol in the display.

### Deactivating the bridge mode

- Press the bridge button on the left (or on the right; only for SIVK6ETS) again.  
*The bridge indicator and the bridge symbol in the display will disappear. The cooking zones are set to '0'.*





## Keeping food warm

The function to keep food warm keeps the temperature of the food at a constant 42 °C. The selected cooking zone is operated with low power. When this function is active, the display shows the 'keeping food warm' symbol.

### Switching on the function to keep food warm

This setting is situated between setting '0' and setting '1', so you must touch the left side of the multi slider.



*The hob is switched on and a pan is on the cooking zone.*

- Touch and slide your finger (to the right) over the multi slider of the desired cooking zone to choose the correct setting (between '0' and '1').

*'u.' will appear in the display, the keeping food warm function is active.*

### Switching off the keeping food warm function

*The function to keep food warm is switched on. The display shows 'u.'*

- Touch and slide your finger (to the left) over the multi slider of the desired cooking zone to choose setting '0'.

*The display shows setting '0.'. The cooking zone is switched off.*

## Child lock

Your induction hob is equipped with a childproof lock that lets you lock the appliance for cleaning or to prevent unintended switching on by children.

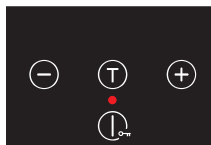

### Switching on the child lock

*The lock mode can be activated in all modes.*

- Touch and hold the On/Off button for 3 seconds to switch on the child lock.

*The red light above the On/Off button is constantly illuminated and you will hear a long beep. All active zones will go totally off.*

- Touch and hold the On/Off button again for 3 seconds to switch off the child lock.

*The red light above the On/Off button disappears and you will hear a long beep.*



### Tip

Switch the hob to child lock mode before cleaning it to prevent it from accidentally switching on.

## Cooking timer/Egg timer

A cooking timer can be set for each cooking zone. All of the cooking timers can be used at the same time. The hob also has an egg timer. Both the cooking timer and the egg timer can be set to a maximum of 99 minutes.

The egg timer works the same way as the cooking timer, but is not linked to a cooking zone. If set, the egg timer will continue to run after the hob has been switched off. The egg timer can only be switched off when the hob is switched on.

The cooking timer	The egg timer
The cooking timer must be linked to a cooking zone. This means that the cooking zone switches off when the set time elapses.	The egg timer is not linked to a cooking zone. The egg timer continues after the hob has been switched off.



### Switching on the egg timer

*The hob is switched on, all displays show '0.' (no cooking zone is active).*

- Press the timer button once.  
*'00.' is shown in the display with a blinking dot. There is no timer indicator in the timer display.*

- Use the - button or the + button to set the desired time.
- Press the timer button again to confirm the setting.

*The egg timer starts. After 10 seconds the hob automatically switches off, the egg timer continues.*

- If you do not set a time with the - and the + button, the egg timer will automatically switch off after 10 seconds.

### Switching off the egg timer

*The hob must be switched on, all displays show '0.' (there is no cooking zone active).*

- Press the timer button once.  
*The remaining time is shown in the display with a blinking dot. There is no timer indicator in the timer display.*

- Touch and hold the - button until '01.' appears in the display. Press the - button one more time; '00' appears in the display.

*The egg timer is now switched off.*

- You can also touch the - button and the + button simultaneously to switch off the egg timer at once.



## Assigning and switching on the cooking timer

*The hob is switched on, at least one cooking zone is active (the cooking timer can only be linked to active cooking zones).*

- Press the timer button several times until the timer indicator (corresponding to the correct cooking zone) in the timer display starts blinking.  
*'00' is shown in the display. There is a timer indicator in the timer display and a timer symbol in the display of the corresponding cooking zone; both will blink.*
- Use the - button or the + button to set the desired time.
- Press the timer button again to confirm the setting.  
*The cooking timer starts.*
  - If you do not use the - and the + buttons to set a time, the cooking timer will automatically switch off after 10 seconds.
- Repeat the steps to set the time for another active cooking zone.



## Attention

When there is more than one timer active, the display will show the shortest remaining time and the timer dot corresponding to it.

## Switching off the cooking timer

- Press the timer button several times until the timer indicator (corresponding to the correct cooking zone) in the timer display starts blinking.  
*The remaining time is shown in the display with a blinking indicator.*
- Touch and hold the - button until '01.' appears in the display. Press the - button one more time; '00' appears in the display.  
*The cooking timer is now switched off.*
  - You can also touch the - button and the + button simultaneously to switch off the cooking timer at once.

## Switching off the cooking timer/egg timer alarm

When the set time/cooking time has elapsed, you will hear the alarm.

- Touch any button to switch off the alarm.



## Tip

- You can touch and hold the - or the + button to set the desired cooking time faster.

## Healthy cooking

### **Burning point of different types of oil**

To ensure your food is fried as healthily as possible, Gorenje+ recommends choosing the type of oil according to the frying temperature. Each oil has a different burning point at which toxic gasses are released. The below table shows the burning points for various types of oil.

Oil	Smoke point °C
Extra virgin olive oil	160 °C
Butter	177 °C
Coconut oil	177 °C
Canola oil	204 °C
Virgin olive oil	216 °C
Sunflower oil	227 °C
Corn oil	232 °C
Peanut oil	232 °C
Rice oil	255 °C
Olive oil	242 °C

## Cooking settings

Because the settings depend on the quantity and composition of the contents of the pan, the table below is intended as a guideline only.

### **Use setting 'boost' and setting 9 to:**

- bring the food or liquid to the boil quickly;
- 'shrink' greens;
- heat oil and fat;
- bring a pressure cooker up to pressure.

### **Use setting 8 to:**

- sear meats;
- fry flatfish;
- fry omelettes;
- fry boiled potatoes;
- deep fry foods.

### **Use setting 7 to:**

- fry thick pancakes;
- fry thick slices of breaded meat;
- fry bacon (fat);

# COOKING

---

- fry raw potatoes;
- make French toast;
- fry breaded fish.

**Use setting 6 and 5 to:**

- complete the cooking of large quantities;
- defrost hard vegetables;
- fry thin slices of breaded meat.

**Use settings 1-4 to:**

- simmer bouillon;
- stew meats;
- simmer vegetables;
- melting chocolate;
- melting cheese.

## ***Cleaning***

---

### **Tip**

Set the child lock before you start cleaning the hob.

### **Daily cleaning**

- Although food spills cannot burn into the glass, we nevertheless recommend you to clean the hob immediately after use.
- Best for daily cleaning is a damp cloth with a mild cleaning agent.
- Dry with kitchen paper or a dry teacloth.

### **Stubborn stains**

- Stubborn stains can also be removed with a mild cleaning agent such as washing-up liquid.
- Remove water marks and lime scale with vinegar.
- Metal marks (caused by sliding pans) can be difficult to remove. Special agents are available.
- Use a glass scraper to remove food spills. Melted plastic and sugar is also best removed with a glass scraper.

### **Never use**

- Never use abrasives. They leave scratches in which dirt and lime scale can accumulate.
- Never use anything sharp such as steel wool or scourers.

# FAULTS

## General



If you notice a crack in the glass top (however small), switch the hob off immediately, unplug the hob, turn off the (automatic) fuse switch(es) in the meter cupboard or, in the event of a permanent connection, set the switch in the power supply lead to zero. Contact the service department.

## Troubleshooting table

If the appliance does not work properly, this does not always mean that it is defective. Try to deal with the problem yourself first by checking the points mentioned below.

Symptom	Possible cause	Solution
Symbols appear in the displays when the hob is activated for the first time.	This is the standard set-up routine.	Normal operation.
The fan remains active for several minutes after the hob has been switched off.	The hob is cooling.	Normal operation.
A slight smell is noticeable the first few times the hob is used.	The new appliance is heating up.	This is normal and will disappear once it has been used a few times. Ventilate the kitchen.
You can hear a ticking sound in your hob.	This is caused by the capacity limiter on the front and back zones. Ticking can also occur at lower settings.	Normal operation.
The pans make a noise while cooking.	This is caused by the energy flowing from the hob to the saucepan.	At high settings this is perfectly normal for some pans. It will not damage either the pans or the hob.
You have switched on a cooking zone, but the display keeps flashing.	The pan you are using is not suitable for induction cooking, or has a diameter of less than 12 cm.	Use a suitable pan, see page 11 and 12.
A cooking zone suddenly stops working and you hear a signal.	The preset time has ended.	Switch the bleep off by pressing any key.
The hob is not working and nothing appears in the display.	There is no power supply due to a defective cable or a faulty connection.	Check the fuses or the electric switch (if there is no plug).
A fuse blows as soon as the hob is switched on.	The hob has been wrongly connected.	Check the electrical connections.
The hob simply switches off.	You accidentally touched the On/Off button.	Switch the hob back on.

## FAULTS

Symptom	Possible cause	Solution
Fault code ER22.	The control panel is filthy or has water on it.	Clean control panel.
Fault code E2.	The hob has overheated.	Let the hob cool down and then use a lower setting.
Fault code E3.	The pan you are using is not suitable.	Use a suitable pan, see page 11 and 12.
Fault code U400.	The voltage is too high and/or the hob is not properly connected.	Have your connection changed.
Fault code  .	An identified permanent use of the slider area or buttons.	Do not touch a multi slider or a button too long.
Other fault codes.	Defective generator.	Contact the service department.



# INSTALLATION

## What you need to consider

### Safety instructions for the installation

- The connection must comply with national and local regulations.
- The appliance must always be earthed.
- This appliance may only be connected by a competent electrical installer.
- For the connection, use an approved cable (for example type HO7RR) in accordance with the regulations. The cable casing should be made of rubber.
- The connection cable must hang freely and is not to be fed through a drawer.
- If you want to make a fixed connection, make sure that a multi-polar switch with a contact separation of at least 3 mm is fitted in the supply line.
- If the connecting cable is damaged, it may only be replaced by the manufacturer, the manufacturer's service organisation or equivalently qualified persons, in order to avoid dangerous situations.
- The worktop the hob is built into must be flat.
- The walls and the worktop surrounding the appliance must be heat resistant up to at least 85 °C. Even though the appliance itself does not get hot, the heat of the hot pan could discolour or deform the wall.
- Damage caused by incorrect connection, installation or use, will not be covered by the guarantee.
- Connection point, wall mounting socket and/or plug must be accessible at all times.



### Clearance

Sufficient all-round clearance is essential to the safe use of the hob. Check that there is enough clearance.

\* 600 mm

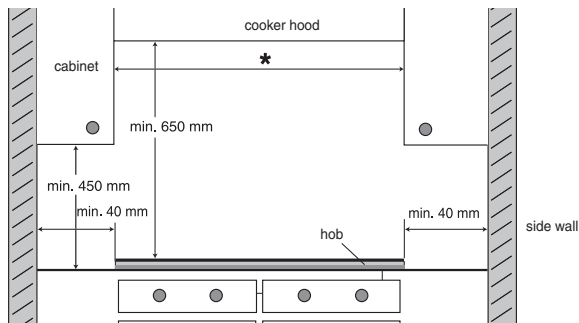

# INSTALLATION

## Installation dimensions

The dimensions and recesses are shown in the illustrations below.

### SIVK6GTS SIVK6ETS

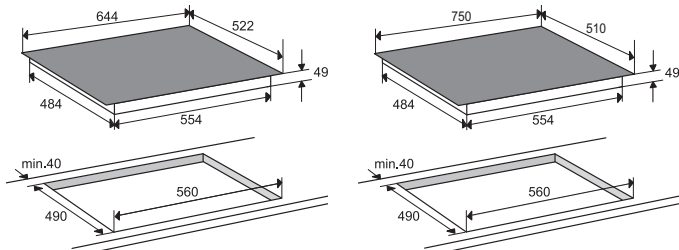

If the hob is wider than the cupboard, with a worktop less than 48 mm thick, saw a cut-out in both sides of the cupboard, so the appliance is detached from the cupboard.

Installation dimensions

inside the cabinet

$x < 48 \text{ mm}$ :  $y = 48 \text{ mm} - x$

$x \geq 48 \text{ mm}$ :  $y = 0 \text{ mm}$

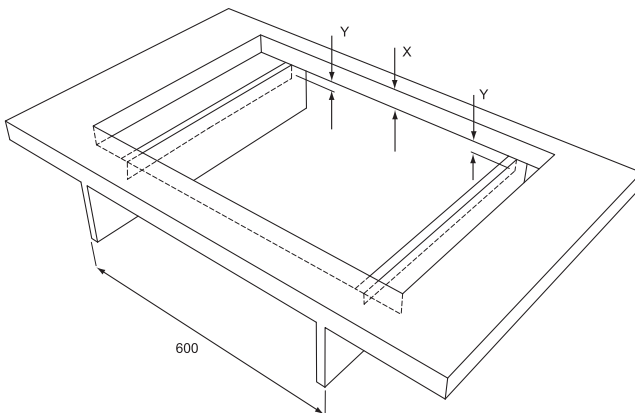

# INSTALLATION

## Ventilation

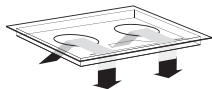

The electronics in the appliance need cooling. The appliance will automatically switch off if there is insufficient air circulation. There are ventilation openings on the underside of the appliance. It must be possible for cool air to be drawn in through these openings. There are outlet openings on the underside and at the front of the appliance.

## Lower kitchen cabinet with a drawer

- An opening at least 140 mm high must be provided on the back wall of the cabinet, along its entire width. Furthermore, a minimum of 6 mm clearance must be provided at the front side, along the entire width of the cabinet.
- The hob is fitted with a fan located in its lower part. In case there is a drawer underneath the kitchen cabinet, no small objects or paper must be kept there, as these could be sucked in by the fan, causing damage to the fan or the entire cooling system. Aluminum foil and inflammable substances or liquids (e.g. sprays) should also not be stored in such drawers or placed near the hob. Danger of explosion! There should be a clearance of 20 mm between the drawer contents and the fan entry slots.

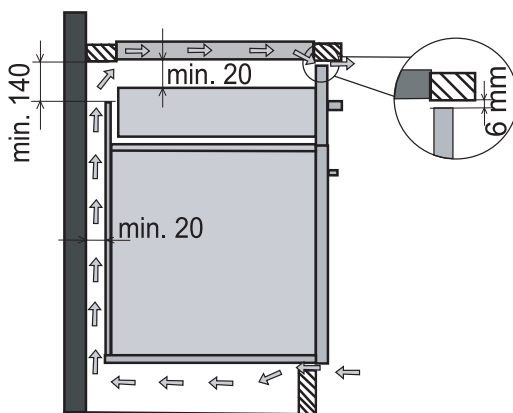

# INSTALLATION

## Lower kitchen cabinet with an oven

- Installing the oven under an induction hob is possible with oven types EVP4..., EVP2..., which are fitted with a cooling fan. Before installing the oven, the rear wall of the kitchen cabinet should be removed. Furthermore, a minimum of 6 mm clearance should be provided at the front side, along the entire width of the cabinet.

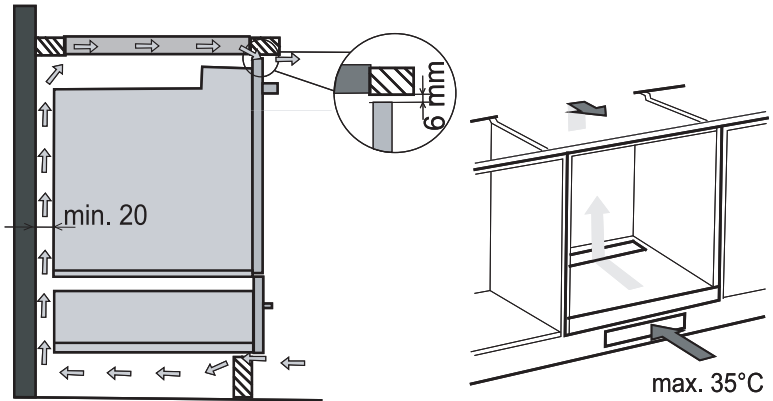

# INSTALLATION

## Electrical connection

### Common connections:

- 2 phase and 1 zero connection (2 1N, 400 V~/ 50 Hz):
  - The voltage between the phases and the neutral is 230 V~. The voltage between the two phases is 400 V~. Fit a connecting bridge between connecting points 4-5. The groups must have fuses of at least 16 A (2x). The core diameter of the connecting cable must be at least 2.5 mm<sup>2</sup>.

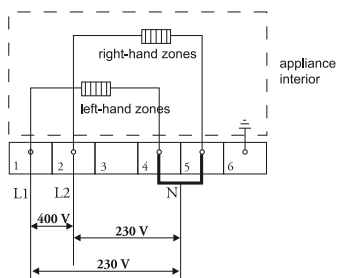

- 2 phase and 2 neutral connection (2 2N, 230 V~ / 50 Hz):
  - The voltage between the phases and the neutral is 230 V~.
  - The group must have fuses of at least 16 A (2x). The core diameter of the connecting cable must be at least 2.5 mm<sup>2</sup>.
- **WARNING:** You may use two live and only one neutral conductor. In this case, make sure a jumper connector is installed over connection points 4 and 5.

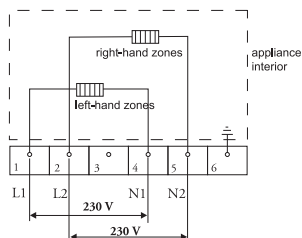

# INSTALLATION

## Special connection:

- Single phase connection (1 1N, 230 V~ / 50 Hz):
    - The voltage between the phase and the neutral is 230 V~.
- Fit a connecting bridge between connecting points 1-2 and 4-5.  
The group must have a fuse of at least 32 A. The core diameter of the connecting should be at least 6 mm<sup>2</sup>.

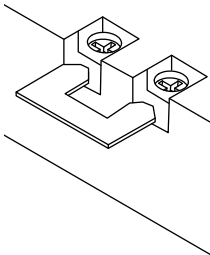
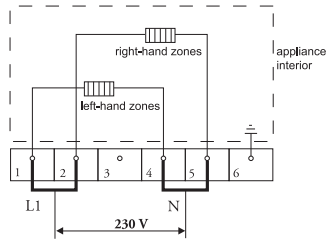

The bridges on the connecting block can be used to create the required connections, as indicated in these illustrations.

Fix the cable with a pull relief and close the cover.

Connection point, wall-mounting socket and plug must be accessible at all times.

# INSTALLATION

## Building in

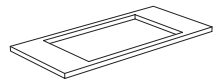

Check that the cabinet and the cut-out meet the dimension and ventilation requirement

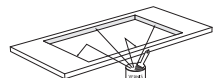

Treat the sawn ends of wooden or synthetic worktops with sealing varnish if necessary, to prevent moisture causing the worktop to swell.

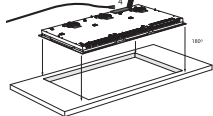

Lay the hob upside down on the worktop.

Fit the connecting cable to the appliance in compliance with the requirements (see page 29 and 30).

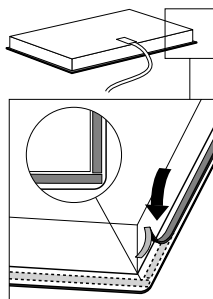

Remove the protective layer from the sealing tape and apply the tape in the groove of the aluminium profile or on the edge of the glass plate. Do not stick tape round the corners, but cut 4 separate pieces to seal the corners well.

Turn the hob over and lay it in the recess.

Connect the appliance to the mains. The displays will light up briefly. The appliance is ready for use.

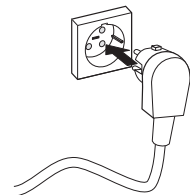

Check that it works properly. If the appliance has been wrongly connected nothing will appear in the displays, depending on the error.

# INSTALLATION

## Technical details

This appliance complies with all relevant CE directives.

<b>Hob type</b>	<b>SIVK6GTS</b>	<b>SIVK6ETS</b>
Induction	x	x
Connection	230V - 50Hz	230V - 50Hz
Max. capacity cooking zones		
Front left	3,7 kW (octa 180x220 mm)	3,7 kW (octa 180x220 mm)
Rear left	3,7 kW (octa 180x220 mm)	3,7 kW (octa 180x220 mm)
Rear right	3,0 kW (Ø180 mm)	3,7 kW (octa 180x220 mm)
Front right	3,0 kW (Ø180 mm)	3,7 kW (octa 180x220 mm)
Center right	-	-
Connected load		
L1	3700 W	3700 W
L2	3700 W	3700 W
L3		
Total connected load	7400 W	7400 W
Building in dimensions		
Appliance width x depth	644 x 522 mm	644 x 522 mm
Build-in height from top of worktop	49 mm	49 mm
Cut-out width x depth	560 x 490 mm	560 x 490 mm
Minimal distance cut-out to back wall	40 mm	40 mm
Minimal distance cut-out to side wall	40 mm	40 mm



### Disposal of packaging and appliance

In the manufacturing of this appliance durable materials were used. Make sure to dispose of this equipment responsibly at the end of its lifecycle. Ask the authorities for more information regarding this.

The appliance packaging is recyclable. The following may have been used:

- cardboard;
- polythene film (PE);
- CFC-free polystyrene (PS hard foam).

Dispose of these materials in a responsible manner and in accordance with government regulations.

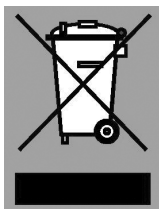

As a reminder of the need to dispose of household appliances separately, the product is marked with the symbol of a crossed-out wheeled dustbin. This means that at the end of its working life, the product must not be disposed of as urban waste. It must be taken to a special local authority differentiated waste collection centre or to a dealer providing this service.

Disposing of a household appliance separately avoids possible negative consequences for the environment and health deriving from inappropriate disposal and enables the constituent materials to be recovered to obtain significant savings in energy and resources.





