

Installation instructions

For flush installation of a frameless hob
with cement set and sealing strips



J004133-R12

12/06/2018

Validity

These installation instructions apply to the following models:

005, 008, 009, 027, 028, 031, 032, 039–041, 226, 307, 527, 533, 878, 973–979, 84A, 87A–91A, 94A–97A, 31001–31200

Accessories

Designation	Article no.
Instant adhesive for installation of the steel angle (50 ml)	B11657
Straight mixing nozzle, 10x	B11656
TREMCLEAN isopropyl alcohol (1000 ml)	1056609
Black silicone FA880 (310 ml)	B11555
Anthracite silicone FA880 (310 ml)	B11556
White silicone FA880 (310 ml)	1031313
Stone grey silicone FA880 (310 ml)	1031314
Marble smoothing agent AA320 (1000 ml)	B11557
Fugenboy set (silicone finishing tool set)	B75158



In case of doubt as to the suitability of cement set materials, especially when using them for the first time, we recommend that you carry out adhesion trials on test pieces or at non-visible locations.

Sealing strip set included with the hob

Art. no.	Characteristics	Thickness × width	Length per roll
H63283	Sealing strip, open-cell (soft)	5 mm × 8 mm	2.75 m
	Spacer set (H60330)	0.5/1.0/2.0 × 7 mm	–



Cut-out with integral mounting surfaces or with mounting angles

Cut-out dimensions

It is recommended to use a work surface (cover) with a material thickness of **at least 20 mm**. Ream out the cut-out as accurate and rectangular as possible and ensure compliance with the stated measurement tolerances.

 **Access must be guaranteed to the hob from below over the entire cut-out area. For servicing, the entire hob base can be taken out from below. It must be possible for touch protection covers to be unscrewed and removed from underneath.**

Cut-outs up to the end of 2012 and for Quicklight hobs

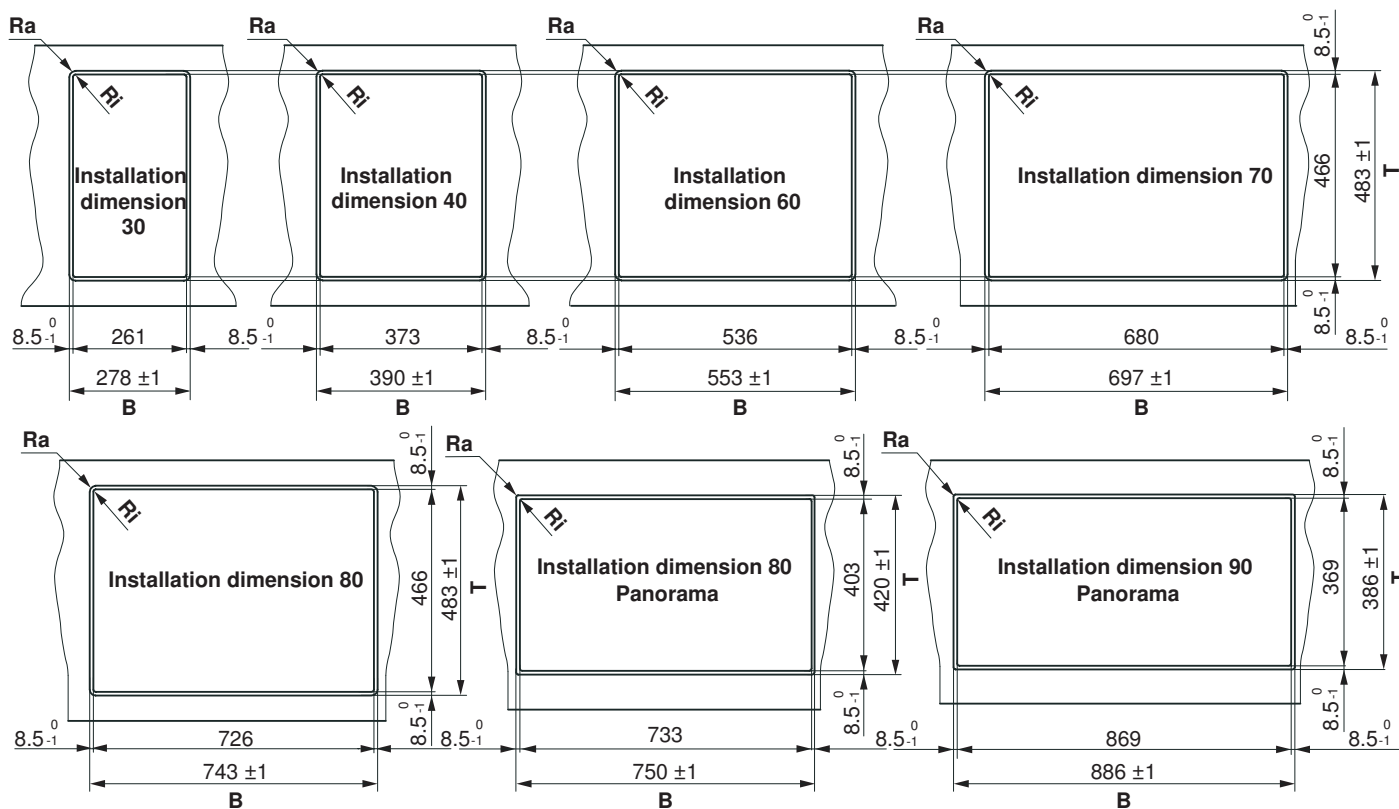

Creating the hob mounting

The mounting surface can either be reamed out (Fig. 1), or created by installing wood/stone supports (Fig. 2) or steel angles (Fig. 3).

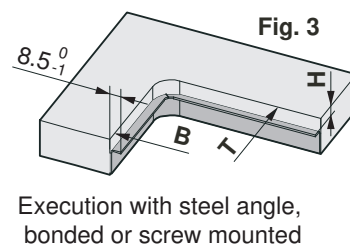
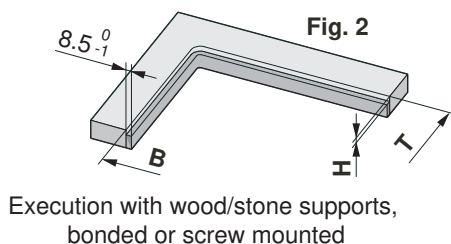
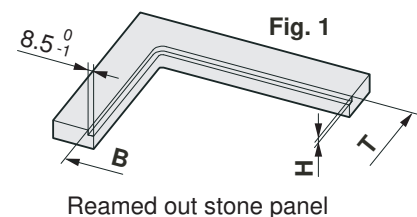

Installation dimension	H	Ra	Ri	Art. no. angle set
30	8.5 0/+1	14	0-5	H62570
40	8.5 0/+1	14	0-5	H62571
60	8.5 0/+1	14	0-5	H62084
70	8.5 0/+1	14	0-5	H62567
80	8.5 0/+1	14	0-5	H62085
90	8.5 0/+1	14	0-5	H62981
80 Panorama	8.5 0/+1	5	0-5	H62679
90 Panorama	8.5 0/+1	5	0-5	H62568

Installation instructions

For flush installation of a frameless hob
with cement set and sealing strips



J004133-R12

12/06/2018

Cut-outs from the beginning of 2013 for Toptronic, induction and gas hobs

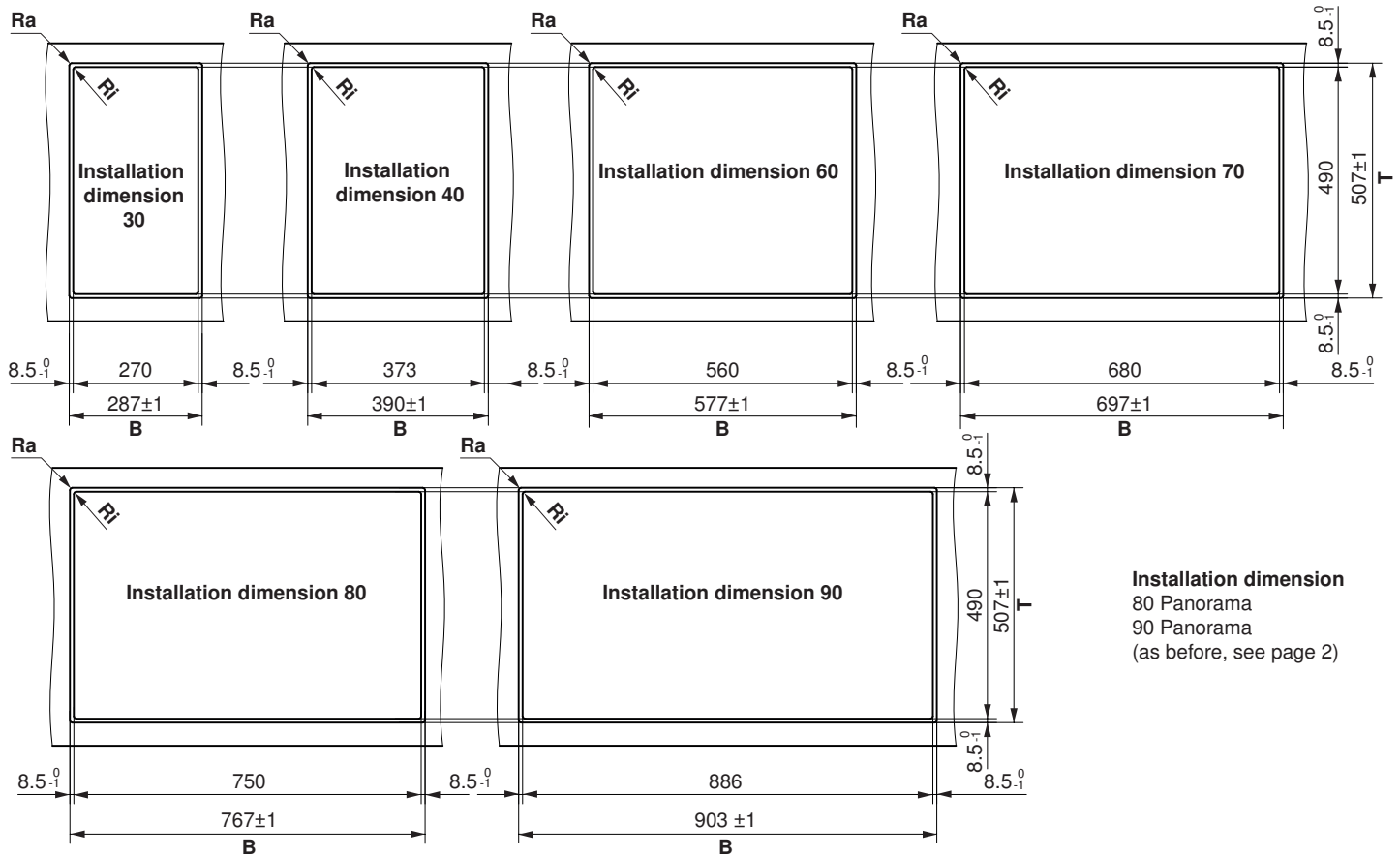

Creating the hob mounting

The mounting surface can either be reamed out (**Fig. 1**), or created by installing wood/stone supports (**Fig. 2**) or steel angles (**Fig. 3**).

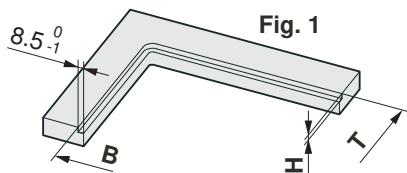

Reamed out stone panel

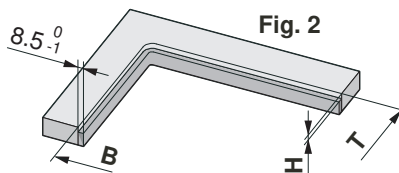

Execution with wood/stone supports,
bonded or screw mounted

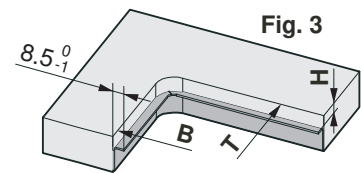

Execution with steel angle,
bonded or screw mounted

Installation dimension	H	Ra	Ri	Art. no. angle set
30	8.5 0/+1	5	0-5	H63770
40	8.5 0/+1	5	0-5	H63771
60	8.5 0/+1	5	0-5	H63772
70	8.5 0/+1	5	0-5	H63773
80	8.5 0/+1	5	0-5	H63774
90	8.5 0/+1	5	0-5	H63775
80 Panorama	8.5 0/+1	5	0-5	H62679
90 Panorama	8.5 0/+1	5	0-5	H62568

Installation instructions

For flush installation of a frameless hob
with cement set and sealing strips



J004133-R12

12/06/2018

Steel angle set

When using the steel angle set, the cut-out $B \times T$ and the corner radius can be cut smoothly over the entire worktop thickness. The correct position of the sides of the angle mounting with reference to the work surface is set with the two spacer gauges supplied.



The steel angles can be screw mounted with wood surfaces.

1. Thoroughly clean and degrease the cut surface of the stone with isopropyl alcohol.
2. Coat the bonding surfaces on the stone side sparingly with instant adhesive (**Fig. 4**).
3. Thoroughly clean and degrease the bonding surface of the steel angle with isopropyl alcohol.
4. Place the two spacer gauges on the first mounting angle (**Fig. 4**).
5. Place the spacer gauges on the work surface, position the mounting angle centrally on the cut edge of the stone (**Fig. 6**) and apply pressure (**Fig. 5**). The adhesive is sufficiently hardened after approx. 5 minutes and both spacer gauges can be removed. Keep the spacer gauges for future use.
6. Bond the other three mounting angles using the same procedure.

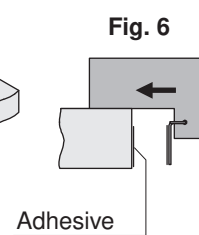
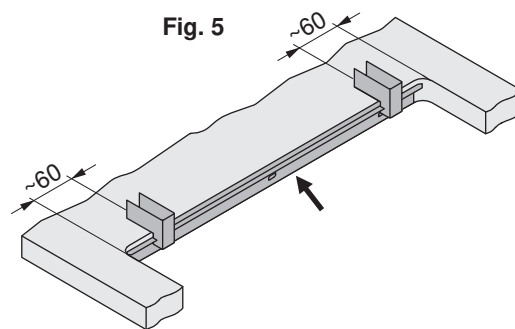
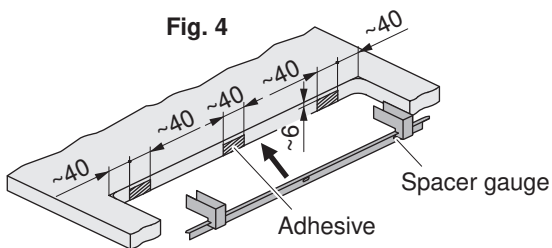

The instant adhesive requires a curing time (waiting time) of at least 1 hour to achieve the final strength and elasticity.

Preparing the cut-out



Lack of care in the preliminary work can result in the ingress of liquid which will lead to the swelling of the wood, damaging the work surface.

In the case of special work surface materials, the use of unsuitable pre-treatment and adhesive materials can sometimes cause colour changes along the bonding and sealing joint.

- Make sure the cut-out is clean, free of dust and any other dirt.

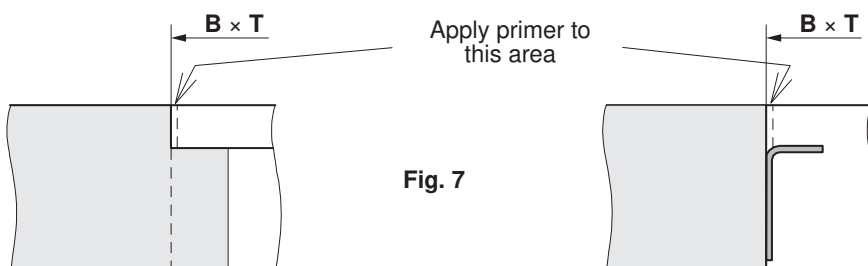

Installation instructions

For flush installation of a frameless hob
with cement set and sealing strips



J004133-R12

12/06/2018

Installation and cementing-in

1. Clean any grease or dirt from the edges of the hob with isopropyl alcohol. Leave to dry for a short time. Do not use water with washing-up liquid!
2. Carefully place the hob in the prepared cut-out and with the help of the spacer set ensure that it sits flush with the surface of the worktop.
3. Remove the hob. Position the spacer plates and fix them with adhesive tape.
4. Stick the self-adhesive sealing strip (8 × 5 mm) supplied with the hob to the cleaned edge mounting surface between the spacer plates (**Fig. 8**).

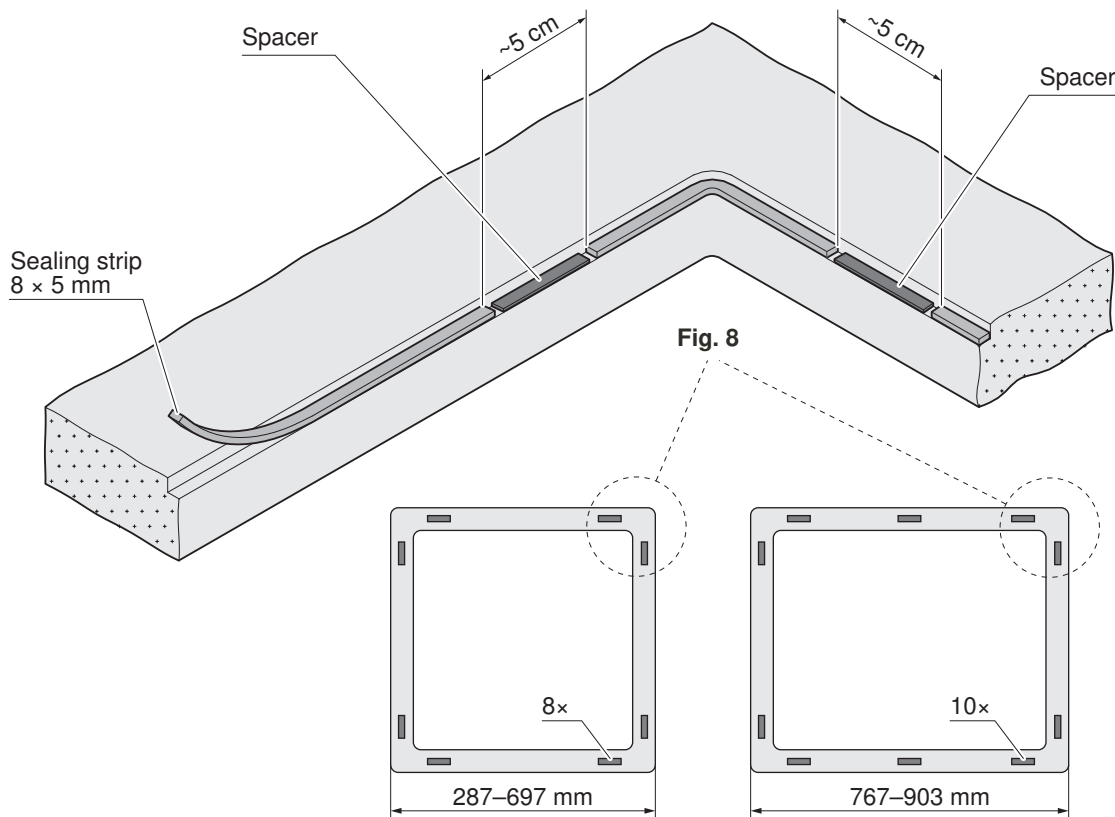

 **As appropriate, the edges of the cut-out and the hob can be covered with wide masking tape before commencing the cementing-in work, so that only the sealing gap is exposed.**

5. Carefully place the hob in the prepared cut-out and with the help of the fugenboy (silicone finishing tool) align it so that the sealing joint is uniform all around.
6. Check both axes are horizontal using a spirit level.

 **Do not press against the edge of the hob with any tools!**

7. Press the silicone adhesive into the sealing joint, avoiding air bubbles and drawing a somewhat raised bead.
8. Spray the silicone bead with smoothing agent.
9. Using the fugenboy (silicone finishing tool), which has also been sprayed with smoothing agent, spread the silicone bead so it is flush. Keep cleaning the fugenboy and spraying it and the silicone joint with smoothing agent.

 **The silicone adhesive requires a curing time (waiting time) of at least 24 hours to achieve the final strength and elasticity. During this time the hob is not to be placed in operation nor subjected to any form of mechanical stress. For this reason (impermissible mechanical stress), the final cleaning of the hob is only to take place after the expiry of this waiting time. Cover the hob with cardboard or similar to prevent dust and dirt from settling during the drying phase.**