

Haier

User Manual

HW60-1279

HW70-1279

HW70-1479

HW80-1479



Thanks for purchasing a Haier Product

Please read these instructions carefully before using this appliance. The instructions contain important information which will help you get the best out of the appliance and ensure safe and proper installation, use and maintenance.

Keep this manual in a convenient place so you can always refer to it for the safe and proper use of the appliance.

If you sell the appliance, give it away, or leave it behind when you move house, make sure you also pass on this manual so that the new owner can become familiar with the appliance and safety warnings.

Accessories

Check the accessories and literature in accordance with this list:

1x User Manual



1x Drain hose brocket

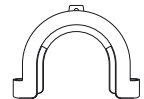

1x Bottom Cover



4x Blanking Plugs



1x Warranty Card



1x Inlet hose assembly

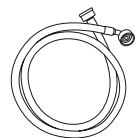

Cautions.....	3
Before Use	5
Functions.....	8
Maintenance	16
Trouble-Shooting.....	19
After-Sale Service.....	21

Legend



Yes



No



Optional



Caution



Attention

Disposal

The presence of this symbol on the product, accessories or materials that goes with this information indicates that at the end of its useful life the product should be disposed correctly according to legal disposal requirement.



To prevent possible damage to the environment or human health from uncontrolled waste disposal, please separate these items from other types of waste and recycle them. This will promote the sustainable reuse of material resources.

Household users should contact either the retailer where they purchased the product or the relevant local authorities to find out how they can take this item for environmentally safe recycling and safe.

Business users should contact their supplier and check the conditions of the purchase. This product and its electronic accessories should be mixed with other commercial waste.

Before switching the appliance on for the first time

Do...

- ✓ Make sure that the transport bolt is removed.
- ✓ Use a separate earthed socket for the power supply.
- ✓ Make sure that the plug is accessible.
- ✓ Hold the plug and not the electric cable when unplugging the power supply.
- ✓ Make sure that the fuses in the power circuit are rated for 13A.
- ✓ Keep it away from heat sources and direct sunlight to prevent plastic and rubber components from ageing.
- ✓ Make sure that the power card is not caught under or in the appliance and avoid damage to the power cable.
- ✓ Check that hose joints and connections are firm and with no water leaks. If joints are not firm there will be leakage, turn off the water supply and secure all connections and joints and ensure there are no leaks. Do not use the washing machine until the hoses are totally fixed.

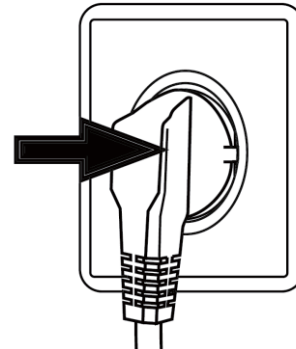

Do not...

- ✗ Touch or use the appliance when barefoot or with wet or damp hands or feet.
- ✗ Use flammable detergent or dry cleaning agent.
- ✗ Use any flammable sprays in close vicinity to the appliance.
- ✗ Remove or insert the plug in presence of flammable gas.
- ✗ Allow children or infirm persons to play with the appliance or packing materials.
- ✗ Install the appliance outdoors in a damp place, or in an area which may be prone to water leaks such as under or near a sink unit. In the event of a water leak allow the machine to dry naturally.
- ✗ Place the washing machine directly on a carpet, or close to a wall or furniture.

During daily use of the appliance

Do...

- ✓ Pull up zips and fix loose threads to prevent the items from being entangled. If necessary, put small items into a small bag or pillow.
- ✓ Turn off the machine after each wash program and switch it off at the mains to save electricity, and for safety. Wipe clean the lower part of the porthole.
- ✓ Keep the door slightly open when the washing machine is not in use to prevent formation of odours.

Cautions

- ✓ Let the power cord be replaced by the manufacturer, his service agent or other accordingly qualified people, in case it is damaged.
- ✓ Ensure that the appliance is not used by people with reduced physical, sensory or mental capabilities, lack of experience and knowledge without supervision or instruction by a person that responsible for their safety.
- ✓ Supervise children to ensure that they don't play with the appliance.

Do not...

- ✗ Touch de washer door during the washing process, it gets hot.
- ✗ Place heavy objects or sources of heat or damp on top of the appliance.
- ✗ Hot wash from rubber or sponge-like materials
- ✗ Open the detergent distribution drawer during the wash cycle.
- ✗ Force the washer door to open, the door is fitted with a self-lock device and will open shortly after the washing procedure is ended.
- ✗ Open the washer door if the water level is visibly over the porthole.
- ✗ Cover the washing machine with a plastic cover so that the moisture inside cannot escape.

Saving Tips

- ⚠ Achieve the best use of energy, water, detergent and time by using the recommended maximum load size
- ⚠ Do not exceed the detergent dosages indicated in the manufacturer's instructions
- ⚠ Use a Eco-Ball or the detergent manufactures supplied detergent dosage cup or ball to ensure the correct amount of detergent is used.
- ⚠ Use "Prewash" for heavily soiled laundry only. Save detergent, time, water and energy consumption by not selecting "Prewash " for slightly to normal soiled laundry.
- ⚠ Save energy and time by selecting a high spin speed to reduce the water content in laundry before using a tumble dryer.
- ⚠ Choose a proper washing temperature. Modern detergents can wash with very good result already in lower temperature than 60°C. Only use higher temperature than 60°C for heavily soiled laundry.

Description

This diagram may be slightly different from the layout of the washing machine you have just purchased.

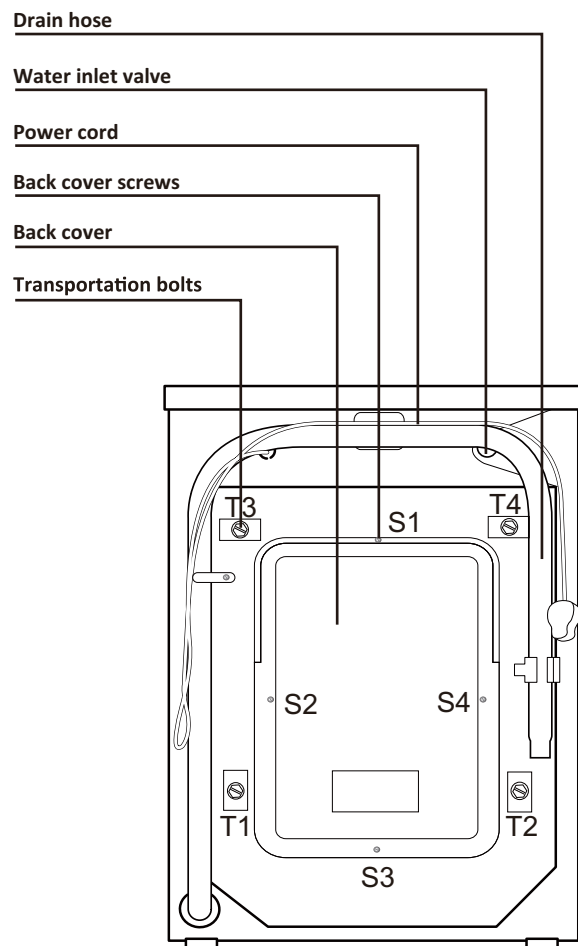

Preparing the machine

Remove all the packing materials to prevent unsteadiness, including the polystyrene base. Upon opening the package, water drops may be seen on the plastic bag and the porthole. This is normal phenomenon resulting from water tests in the factory.

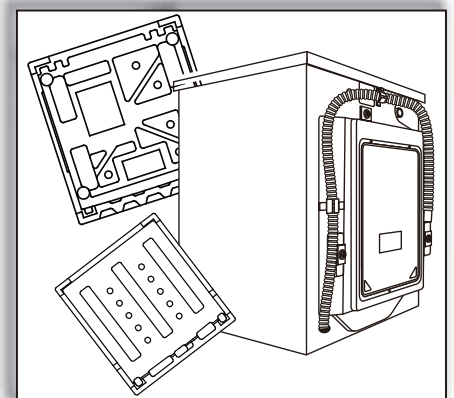

Installation

Adjusting the bottom cover

Before removing the transportation bolts, please fix the bottom cover to the bottom of the washing machine. Lay down the machine (fig.1), unscrew the feet and fit the bottom cover with the four holes corresponding to the screw holes of the feet. Then screw the feet back on through the cover and fix it thus securely to the bottom of the machine (fig 2.).

It keeps out the dampness and reduces the noise.

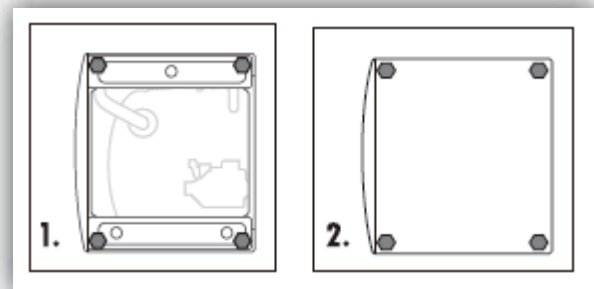

Dismantle the transportation bolts

The transportation bolts are designed for clamping anti-vibration components inside of the washing machine during the transportation process.

- ✓ Remove the back cover.
- ✓ Remove the four bolts on the rear side and take out the synthetic stabilizers from within the machine.
- ✓ Replace the back cover.
- ✓ Fill the holes left by the bolts with blanking plugs.

Note:

- ⚠ When you replace the back cover, the convex must face to outside, and you have to insert the back cover from the two gaps as shown in fig.5.
- ⚠ Keep the transportation bolts and synthetic stabilizers in a safe place for later use.

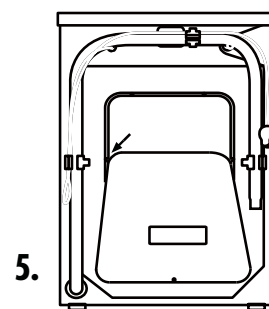
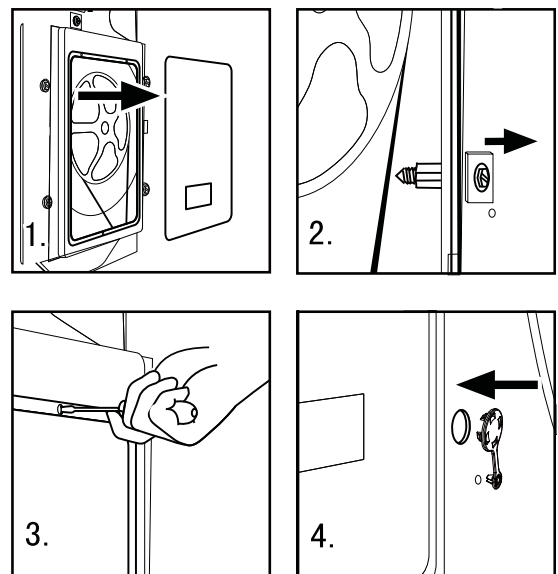

Adjusting the feet

There are adjustable feet under the bottom of the washing machine. Before use, they should be adjusted so that the machine is level. This will minimize vibrations and thus noise during use. It will also reduce wear and tear. We recommend using a spirit level to level the appliance. The floor should be as stable and flat as possible.

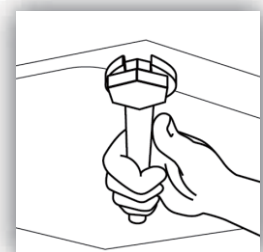

Inlet Hose

- ✓ Connect the nut on the inlet hose to the connector on the water valve.
- ✓ Apply inlet hose to a water tap with cold, fresh water.

⚠ Use the hose-set supplied with the appliance. Old hose-sets should not be reused.

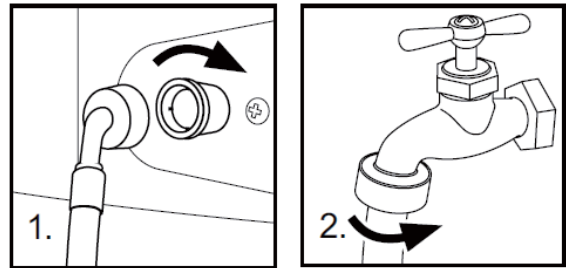

Drain Hose

- ✓ Use the drain hose bracket to keep the end of the drain hose retained and prevents the back flow of water. Don't extend the length of the drain hose; if an extended hose is required, please consult a plumber.
- ✓ The height of the drainage outlet must be 80-100 cm. Fix the drain hose to the clip at the back of the washing machine to prevent it from dropping off.

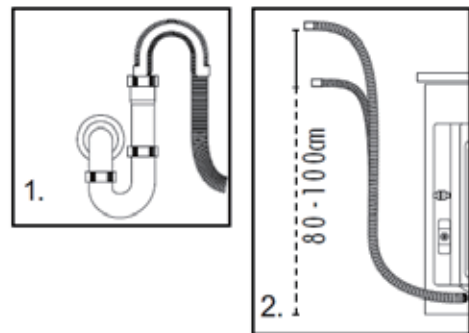

⚠ The drain hose should not be submerged in water and should be securely fixed and leak-free. If the drain hose is placed on the ground or if the pipe is at a height of less than 80cm, the washing machine will continuously drain while being filled (self-siphoning).

Connecting to Power Supply

Before connecting to the power supply, check:

- ✓ The socket is adequate for the maximum power of the washing machine (For safety, fuses in the power circuit should be rated for no less than 13A).
- ✓ The voltage should meet the requirement.
- ✓ The power outlet should be capable of accepting the washing machine plug.
- ✓ Connect the machine to an earthed socket outlet.

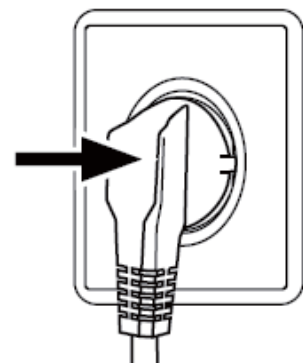



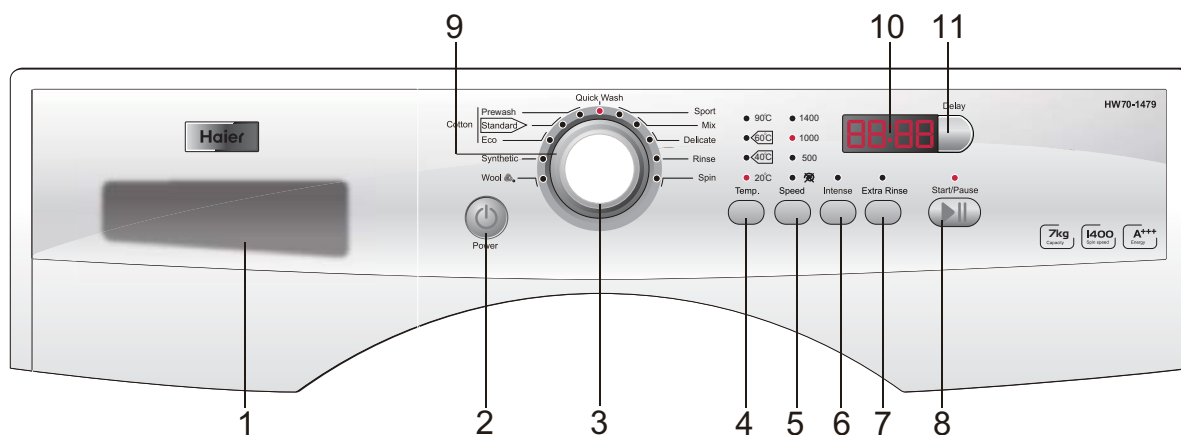

Control Panel

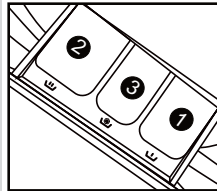

- | | | |
|------------------------------|-----------------------|-----------|
| 1. Detergent/Softener Drawer | 6. Intense button | 11. Delay |
| 2. Power Button | 7. Extra Rinse | |
| 3. Program Dial | 8. Start/Pause Button | |
| 4. Wash Temp | 9. ECO | |
| 5. Spin Speed | 10. LED Display | |

Operational Functions

Nº	Function	Explication
1	Detergent distribution drawer	<p>Open the drawer, three compartments can be seen:</p> <p>Compartment 1: Prewash detergent</p> <p>Compartment 2: Detergent for programs 1 to 9.</p> <p>Compartment 3: Softener, conditioning agent.</p> <p>The recommendation on the type of detergents is suitable for the various washing temperatures, please refer to the manual of detergent.</p> 
2	Power Button	Press this button to switch on the washing machine. Press it again to switch it off. Press this button gently for 2 seconds to switch off the machine as buttons are soft touch sensitive.
3	Program Dial	By turning the knob clockwise/counterclockwise, the required program can be selected. There are 11 programs available. After a program is selected, the corresponding light will illuminate.
4	Wash Temp	Touch this button lightly, the washing temperature will be displayed on the display. Select a temperature according to the type of laundry. Note: If there is no indicator light displayed, it means cold wash.
5	Spin Speed	Touch this button lightly to select the desired speed. When a speed is set, it will be displayed on the display.
		 <p>Different water temperatures and spinning speeds can be set for different laundries. Wash using the default settings if there is no special requirement.</p>
6	Intense button	If the laundry is heavily soiled, press this button before starting the program. When the button is pressed, the washing time increases.

7	Extra Rinse	<p>Press this button, the washing machine will perform additional rinses. Press the button once to select one additional rinse. The display will show "P-1". Press the button repeatedly and the screen will display "P-2" or "P-3", indicating two or three additional selected rinses. The "extra rinse light" is activated and flashes during the performance. "P-1/2/3" is displayed alternating with the remaining time. The light turns off and the display disappears when the extra rinse ends.</p> <p> Select this function when programme 1-9 is selected.</p>
8	Start/Pause Button	<p>When the washing machine is connected to the power socket and a program is selected, lightly touch this button to start operation. During a wash cycle, touch it lightly, operation will stop and the digits on the display start blinking. Touch it again to resume operation. To cancel a wash program during a wash cycle, touch this button, when the digits on the display start blinking, press the Power switch, the program will be cancelled.</p>
9	ECO	<p>Before a washing program, select this program to set the washing load (1/2 Full), the washing machine will automatically adjust the water consumption and washing time.</p>
10	LED Display	<p>Information as remaining wash time and error messages will be shown here.</p> <p> After a wash program is started the display will go on and the remaining wash time decreases. As the water pressure and temperature may differ, the remaining time may be adjusted accordingly. When the laundry is not balanced during spinning, the time may be automatically prolonged.</p>
11	Delay	<p>Touch this button lightly, the washing machine will start operation after a period of time and the corresponding indicator will go on. The range is 0.5-24 hours; each touch of this button increases a half hour. After the button is set, press the Start/Pause button to start countdown of the set time (the time is displayed on the screen until the program ends).</p> <p> The delay time must be longer than the program time otherwise the washing machine will start the wash program directly.</p>
To cancel audible alarm		<p>Alarm sound can be cancelled if it is required (not recommended) Switch on the washing machine and turn the program knob to spin cycle, then press the "Delay" and "Extra rinse" button, hold on for 3 seconds. The message "BEEP OFF" will be displayed on the screen, indicating that the alarm sound has been cancelled.</p>
To reinstate audible alarm		<p>Switch on the washing machine and turn the program knob to spin cycle, then press the "Delay" and "Extra rinse" button, hold on for 3 seconds. The "BEEP ON" message will be displayed on the screen, indicating that the alarm sound has been reinstated.</p>

Program Modes

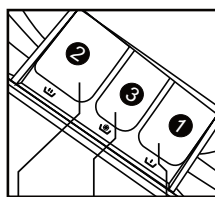

- 1 Detergent compartment for prewash mode
- 2 Detergent compartment
- 3 Compartment for softener

Program	Temp Max	Preset				Fiber type	Preset spin speed
			2	3	1		HW*-1279/HW*-1479
Wool	0-40 °C	20°C	✓	⊙	✗	Woolen fabrics	500 rpm
Synthetic	0-60 °C	40°C	✓	⊙	✗	Chemical fiber fabrics	1000 rpm
Eco	0-90 °C	40°C	✓	⊙	✗	Cotton fabrics	1000 rpm
Standard	0-90 °C	40°C	✓	⊙	✗	Cotton fabrics	1000 rpm
Prewash	0-90 °C	40°C	✓	⊙	✓	Heavy soiling	1000 rpm
Quick Wash	0-20 °C	20°C	✓	⊙	✗	Cotton or synthetic	1000 rpm
Sport	0-40 °C	20°C	✓	⊙	✗	Sports wear	1000 rpm
Mix	0-60 °C	40°C	✓	⊙	✗	Cotton or synthetic	1000 rpm
Delicate	0-40 °C	20°C	✓	⊙	✗	Cotton fabrics	500 rpm
Rinse	--	--	✗	⊙	✗	/	1200/1400 rpm
Spin/Drain	--	--	✗	✗	✗	/	1200/1400 rpm

Yes ✓

Optional ⊙

No ✗

Consumption Table

Program	Temp	Max Load	Washing Time	Spin drying Performance	Energy Consumption	Water Consumption
Wool	20°C	1 kg	1:00 h
Synthetic	40°C	3/3.5/4 kg	1:10 h
Eco	40°C	3/3.5/4 kg	1:18 h
*) Cotton/Standard	40°C	3/3.5/4 kg	2:28/2:28/2:38h	..	0.566/0.545/0.60kwh	32.5/38.4/36L
*) Cotton/Standard	60°C	3/3.5/4 kg	2:48/2:48/2:58 h	..	0.800/0.812/0.87kwh	34.8/37.4/36L
*) Cotton/Standard	60°C	6/7/8 kg	2:48/2:48/2:58 h	53%	0.781/0.777/0.85kwh	51.0/49.5/56L
Prewash	40°C	6/7/8 kg	1:46 h
Quick Wash	20°C	3/3.5/4 kg	0:15 h
Sport	20°C	3/3.5/4 kg	0:25 h
Mix	40°C	6/7/8 kg	1:18 h
Delicate	20°C	3/3.5/4 kg	1:01 h

 The standard 60 °C and 40 °C cotton programs are suitable to clean normally soiled cotton laundry and they are the most efficient programs in terms of combined energy and water consumptions for washing that type of cotton laundry; The actual water temperature may differ from the declared cycle temperature.

- *) Energy Label Program Settings: 1. " Cotton/Standard+40°C+Intense+Max speed"
2. " Cotton/Standard+60°C+Intense+Max speed"

Choose the best Detergent

	Universal	Color	Delicate	Special	Softener
Wool	-	-	-	L	O
Synthetic	L/P	L/P	L	-	O
Eco	L/P	L/P	-	-	O
Standard	L/P	L/P	-	-	O
Mix	L/P	L/P	-	-	O
Delicate	-	-	L	-	O

	Detergent	Temperture range in °C
L	Liquid	cold - 60
P	Powder	40 - 90
O	Optional	---
-	No	---

If using liquid detergent, it is not recommended to activate the delayed start. The amount of detergent necessarily choose to package information!

Info: Modern washing detergents at low temperatures.

Washing Methods

 This washing machine is for domestic use only. If the machine is used for commercial purposes the guarantee will not be valid anymore. Do not use it for purposes other than that for which it was designed. Follow the instructions given on the label of each garment and wash only machine-washable garments.

Power Supply

Connect the washing machine to the power supply (220V to 240V~/50Hz).

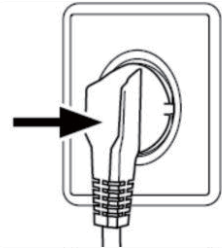

Water Connection

Turn on the tap. The water must be clean and clear.

 Before first wash run the machine without laundry, check for leakage in the joints between the tap and the inlet hose by turning on the tap.

When first using the washing machine, let it run unloaded for one program to prevent the laundry from being tainted by oil or dirty water from the washing machine. Before washing you should run the machine without laundry, but with detergent, with 60°C program.

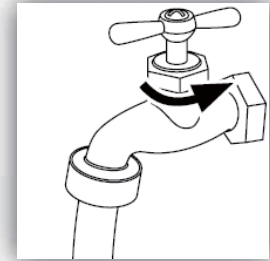

Preparing the Laundry

Sort out clothes according to fabric (cotton, synthetics, wool or silk) and to how dirty they are.

Separate white clothes from colored ones. Wash them first by hand to check if they fade or run.

Empty pockets (keys, coins, etc.) and remove the harder decorative objects (e.g. brooches).



 Attention: Small parts (like buttons, etc) may lead to repair work which user has to pay by him and can cause damage in the machine.

Garments without hems, underwear, and finely woven textile such as fine curtains are to be put into wash bag (it is better not to wash them in a washing machine).

Close zippers and hooks, make sure the buttons are sewn on tightly and place small items such as socks, belts, bras, etc. in the wash bag.

Unfold large pieces of fabric such as bed sheets, bedspreads, etc.

Turn shirts inside out.

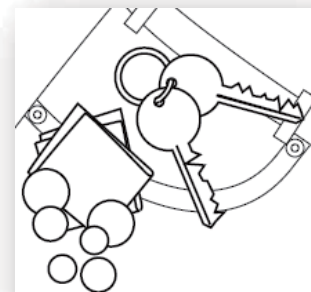

Loading the appliance

Open the washer door put in the laundry piece by piece. Close the door tightly.

Do not overload the washing machine.



Selecting Detergent

The washing efficiency and the performance is determined by the quality of detergent used. Special non-foaming detergent produces good washing results. Use specific detergents for synthetic and woollen goods. Do not use dry cleaning agents such as trichloroethylene and similar products.

- ⚠ Do not add more detergent than needed; otherwise, it may cause the situations as following and washing machine malfunction impacting washing machine's life.
 - ⚠ Due to the increasing foam, the rinse time will be longer than normal;
 - ⚠ The foam may overflow from the detergent drawer because of the increasing pressure of the foam;
 - ⚠ It may remain foam without cleaning out after the final spinning cycle.

🕒 Recommendation:

- 🕒 Clean the detergent drawer once a week.
- 🕒 When using the prewashing program, please add half of the rating dosage.
- 🕒 Please follow the dosage recommendation on the powder or liquid detergent package.

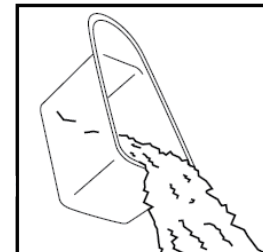

Adding Detergent

Slide out the detergent drawer and put the required detergent and softening agent into the corresponding compartments. Push back the drawer gently. (Refer to the instructions on the drawer)

- ⚠ For prewashing program, detergent should be added to both compartments 1 and 2.
- ⚠ For other programs, do not add detergent to compartment 1.
- ⚠ Use liquid detergent according to the instructions on its package. Do not use liquid detergent if the prewash mode or "Delay" is selected.
- ⚠ Do not overuse softener; otherwise, it will damage the artificial fibers.

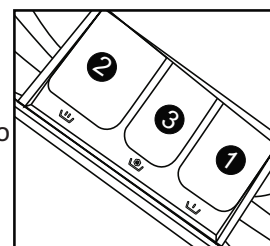

Selecting program

To get the best washing results, an appropriate washing program should be selected according to the laundry type. Please turn the program knob to select the right program.

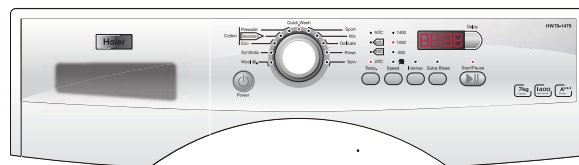

Selecting functional

Select the required options. (Refer to the "Control panel" pages 8, 9 and 10)

Setting washing temperature

Press and hold down the temperature button until the desired temperature is selected.

Setting spin speed

Press and hold down the speed button until the desired speed is selected. See "Operational functions" on the "Control panel" pages (08 and 09) for selecting temperature and spin speed. It is advisable to select the recommended value.











































Washing

Press the Start/Pause button. The washing machine will operate according to the preset programs. The washing machine will stop operation automatically when a washing cycle ends. The "End" sign will appear on the display. Open the washer door and take out the laundry.

After washing

Turn off the water supply and unplug the power cord. Open the washer door to prevent formation of moisture and odours. Leave the door open while not used.

Care Chart

 Machine Wash, COLD	 Hand Wash	 Tumble Dry, NO HEAT	 Do Not Tumble Dry	 Iron, Steam or Dry, with LOW HEAT
 Machine Wash, WARM	 Do Not Wash	 Tumble Dry, LOW HEAT	 Line Dry	 Iron, Steam or Dry, with MEDIUM HEAT
 Machine Wash, HOT	 Bleach as needed Any bleach, like Clorox®, may be safely used	 Tumble Dry, MEDIUM	 Drip Dry	 Iron, Steam or Dry, with HIGH HEAT
 Machine Wash, COLD Permanent Press	 Non-chlorine Bleach as needed Use only a color-safe bleach, like Clorox 2®	 Tumble Dry, HIGH	 Dry Flat	 Do Not Iron with Steam
 Machine Wash, WARM Permanent Press	 Do Not Bleach No bleach product should be used including detergents with bleach - or follow bleach package test procedures to test for bleach safety.	 Tumble Dry, Permanent Press, NO HEAT	 Don't dry clean	 Do Not Iron
 Machine Wash, HOT Permanent Press		 Tumble Dry, Permanent Press, LOW HEAT	 Dry on clothes hanger	 Dryclean May appear with additional letters and/or lines Take this item to a professional drycleaner
 Machine Wash, COLD Gentle Cycle		 Tumble Dry, Permanent Press, MEDIUM	 Tumble dry, Medium heat	 Do Not Dryclean
 Machine Wash, WARM Gentle Cycle		 Tumble Dry, Gentle Cycle, NO HEAT	 Tumble dry, low heat	 Dry cleaning with any solvent
 Machine Wash, HOT Gentle Cycle		 Tumble Dry, Gentle Cycle, LOW HEAT	 Don't tumble dry	 Dry cleaning with pericloride
 Wool Mark		 Tumble Dry, Gentle Cycle, MEDIUM		

Load Reference

Material	Made of	Load in grams
Bed Sheet	Cotton	Approximately 800
Blanket	Wool	Approximately 3000
Blended fabric clothes	/	Approximately 800
Jackets	Cotton	Approximately 800
Jeans	/	Approximately 800
Overalls	Cotton	Approximately 950
Ladies Pyjamas	/	Approximately 200
Shirts	/	Approximately 300
Socks	Blended fabrics	Approximately 50
T-Shirts	Cotton	Approximately 300
Underwear	Blended fabrics	Approximately 70

Cleaning and Care

After washing

Turn off the water supply and pull out electricity plug after each wash. Open the washer door to prevent formation of moisture and odours. If the washing machine is left idle for a long period, drain the water in the machine and replace the drain hose.

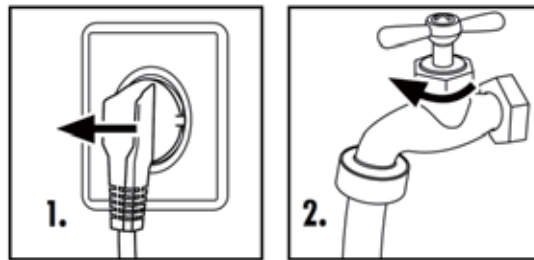

Cleaning the detergent drawer

Clean the detergent distribution drawer regularly.

Pull the drawer (2) fully out then press the conditioner siphon cap (1) to release the release the detergent drawer from the machine, flush it clean with water and then replace it.

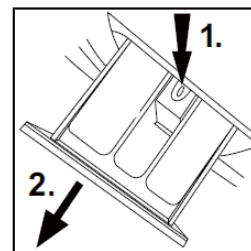

Cleaning the machine

Unplug the machine during cleaning and maintenance. Use a soft cloth dampened with soap liquid to clean the machine case and rubber components. Do not use organic chemicals or corrosive solvents.

Cleaning the filter

Clean the filter once a month:

Open the bottom cover.

Remove the filter by turning counterclockwise.

Flush the filter clean with running water.

Replace the filter by turning clockwise and remount the cover.

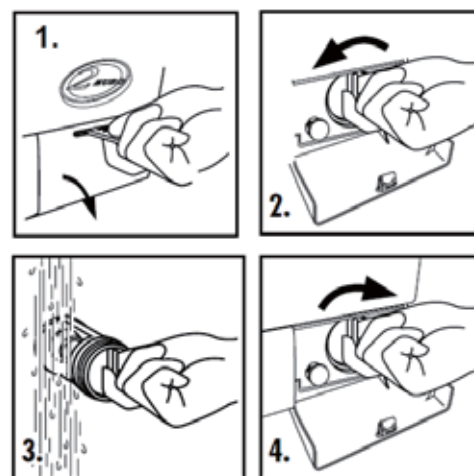

 The filter must be in place, or it may lead to leakage.

 Place a container under the drain pump filter, to collect any excess water that may come out of the drain pump

Water inlet valve and inlet valve filter

To prevent blockage to the water supply by ingress of foreign substances, clean the water inlet valve and inlet valve filter regularly.

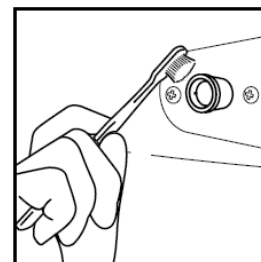

Maintenance or service wash

A maintenance wash is done to clean the washing machine out by running a high-temperature (90°C Cotton) program once a month. The high temperature kills off bacteria and unwanted fungal growth. A service (or maintenance) wash involves putting the washing machine on the hottest wash (90°C Cotton Wash) with only the detergent inside - and no laundry. If you normally use a washing machine detergent that doesn't contain bleach, then buy some detergent that does, and use it for your maintenance washes. This will help kill off bacteria and prevent black mould and grease.

Tip: Look for something like, "bleaching agents" in the ingredients. Do not put cleaning bleach (for example "Domestos") in the washing machine this will damage the machine. There are certain types of bleach example oxygen bleaches like "Vanish" that are appropriate for laundry. To check if your washing machine is being badly affected, carefully examine the inside of the door seal for slime. Pull the lip in front of the drum and look underneath on lip of the tub as it can accumulate a slime, which causes smells, and rots the seal.

Moving the machine

If the machine is to be moved to a distant location, replace the transportation bolts removed before installation to prevent damage as shown below.

Remove the back cover.

Remove the blanking plugs.

Insert the synthetic stabilizers and the transportation bolts.

Tighten the bolts with a spanner.

Replace the back cover.

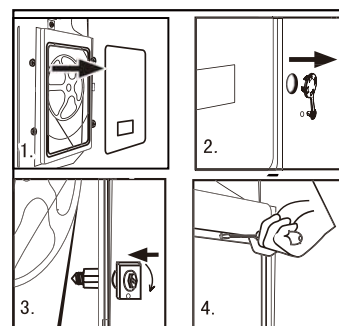

Long periods of disuse





If the washing machine is left idle for a long period, pull out the electrical plug and turn off the water supply. Open the washer door to prevent formation of moisture and odors. Let the door open while not used.

Display Codes

Display Codes and Special functions

Codes	Causes	Solutions
Err1	Door is not properly shut.	Shut the door properly, and then press the Start/Pause button.
Err2	Drainage error, water not emptied within 6 minutes.	Clean the filter and check the drain hose for blockage. If error still exists, please contact the maintenance personnel.
Err3	Temperature sensor not properly connected or damaged.	Contact the maintenance personnel.
Err4	Heater error (Appears at the end of a cycle).	Contact the maintenance personnel.
Err5	Water level not met in 8 minutes. The height of the drain hose is below 80 cm. The drain hose is in water.	Make sure that tap is turned on, and water pressure is normal. If problem still exists, please contact the maintenance personnel. Install drain hose within 80-100 cm of height. Make sure the drain hose is not in water.

Err7	Motor Error	Contact the maintenance personnel.
Err8	Water exceeds protective level.	Contact the maintenance personnel.
UNb	After the last rinsing cycle finishes, spinning fails completely due to unbalance of the laundry.	
End	End of wash cycle.	
19:30	-Status information: Preset time for delayed operation.	
1:25	The remaining time is 1 hour 25 minutes.	

-  Control panel lock function: Press the "Delay" and the "Start/Pause" buttons simultaneously for 3 seconds after starting a program. It can no longer be changed by operating buttons or knobs. To unlock press the "Delay" and "Start/Pause" buttons again for 3 seconds.
-  Power-off memory function: In case of abrupt power failure or the need to cut off the power during a program cycle, the present settings will be saved and the preset operation will resume when the power is on again.
-  To cancel a program. Press the "Start/Pause" button, then switch off the power and the program is automatically cancelled. Turn the program selector again to choose another program.
-  During the spin process, if too much foam is inspected, in order to protect the motor, the washing machine will eliminate the foam automatically; the motor will stop and the drain pump will drain the water. If it happens more than 5 times, the motor will stop until the end of step without spinning.

Trouble-Shooting

Problem	Causes	Solutions
Washing machine fails to operate.	<ul style="list-style-type: none"> ✗ Poor connection to the power supply. ✗ Power failure. ✗ The washer door is not properly closed. ✗ Machine has not been switched on. 	<ul style="list-style-type: none"> ✓ Check connection to the power supply. ✓ Check the power supply. ✓ Close the washer door properly. ✓ Make sure the machine is switched on.
Washing machine cannot be filled with water.	<ul style="list-style-type: none"> ✗ The "Start/Pause" button is not pressed. ✗ Water tap is not turned on. ✗ Water pressure is less than 0,03 MPa. ✗ The inlet hose is kinked. ✗ Water supply failure. ✗ The program knob is not properly set. ✗ The washer door is not properly closed. ✗ The inlet hose filter is blocked. 	<ul style="list-style-type: none"> ✓ Press the "Start/Pause" button. ✓ Turn on the water tap. ✓ Check water pressure. ✓ Check the inlet hose. ✓ Ensure the water supply. ✓ Set the program knob properly. ✓ Close the washer door properly. ✓ Unblock the inlet hose filter.
Machine is draining while being filled.	<ul style="list-style-type: none"> ✗ The height of the drain hose is below 80 cm. ✗ The drain hose is in water. 	<ul style="list-style-type: none"> ✓ Install drain hose within 80-100 cm of height. ✓ Make sure the drain hose is not in water.
Drainage failure.	<ul style="list-style-type: none"> ✗ Drain hose is blocked. ✗ Drain hose end is higher than 100 cm above the floor level. ✗ The filter is blocked. 	<ul style="list-style-type: none"> ✓ Unblock the drain hose. ✓ Make sure the drain hose end is lower than 100 cm above floor level. ✓ Unblock the filter.
Strong vibration while spinning.	<ul style="list-style-type: none"> ✗ Not all transportation bolts have been removed. ✗ Washing machine is located on an uneven surface or is not level. ✗ Machine load is over 6/7/8kg. 	<ul style="list-style-type: none"> ✓ Remove all transportation bolts. ✓ Make sure the washing machine is on an even surface and levelled. ✓ Reduce amount of laundry in the drum.
Operation stops before completing wash cycle.	<ul style="list-style-type: none"> ✗ Water or electricity failure. 	<ul style="list-style-type: none"> ✓ Check the power supply or water supply.
Operation stops for a period of time.	<ul style="list-style-type: none"> ✗ Washing machine gives an error message. ✗ Washing machine is in soaking cycle? 	<ul style="list-style-type: none"> ✓ Check display codes. ✓ Press the rinse hold button or the Start/pause button again to cancel it.
Excessive foam in the drum, which is spilled to the distribution drawer.	<ul style="list-style-type: none"> ✗ The detergent is not a low-foaming type or for manual wash. ✗ Excessive use of detergent. 	<ul style="list-style-type: none"> ✓ Check if your detergent is appropriate. ✓ Reduce amount of detergent in the distribution drawer.
Automatic adjustment of the washing time.	<ul style="list-style-type: none"> ✗ The washing program duration will be adjusted 	<ul style="list-style-type: none"> ✓ This is normal and doesn't affect the functionality.
Spinning fails	<ul style="list-style-type: none"> ✗ Unbalance of the laundry 	<ul style="list-style-type: none"> ✓ Add clothes or run a spinning program again.

Technical Data

Basic technical information regarding the appliance.

	HW70-1279/HW70-1479	HW80-1479
Power source	220 - 240V~/50Hz	220 - 240V~/50Hz
Max. working current (A)	10	10
Water pressure (MPa)	$0.03 \leq P \leq 1$	$0.03 \leq P \leq 1$
Nominal load (kg)	7	8
Spinning speed (r/min)	1200/1400	1400
Washing programs	11	11
Max power (W)	2050	2000
Dimensions (HxDxW mm)	850 x 600 x 595	850 x 650 x 595
Net weight (kg)	71	74
Power consumption of the off-mode(W)	0,48	0,48
Power consumption of the left-on mode(W)	0,48	0,48

	HW60-1279
Power source	220 - 240V~/50Hz
Max. working current (A)	10
Water pressure (MPa)	$0.03 \leq P \leq 1$
Nominal load (kg)	6
Spinning speed (r/min)	1200
Washing programs	11
Max power (W)	2000
Dimensions (HxDxW mm)	850 x 520 x 595
Net weight (kg)	65
Power consumption of the off-mode(W)	0,48
Power consumption of the left-on mode(W)	0,48

Product Fiche (according EU 1061/2010)

Trade mark	Haier	Haier	Haier
Model No.	HW60-1279	HW70-1279/1479	HW80-1479
Rated capacity(kg)	6	7	8
Energy efficiency class	A++	A+++	A+++
Energy consumption per year (kWh) ¹⁾	170	170	179
Energy consumption of cotton 60°C, full load (kWh/cycle)	0.781	0.777	0.85
Energy consumption of cotton 60°C, partial load (kWh/cycle)	0.800	0.812	0.87
Energy consumption of cotton 40°C, partial load (kWh/cycle)	0.566	0.545	0.60
Weighted power consumption of the off-mode	0.48	0.48	0.48
Weighted power consumption of the left-on mode	0.48	0.48	0.48
Water consumption per year (L) ²⁾	9200	9900	9667
Spin-drying efficiency class ³⁾	B	B	B
Max.spin speed (rpm) ⁴⁾	1200	1200/1400	1400
Remaining moisture content (%) ⁴⁾	53	53	53
standard 60 °C cotton program ⁵⁾	Cotton/Standard+60°C +Intense+Max speed (level 3)	Cotton/Standard+60°C +Intense+Max speed (level 3)	Cotton/Standard+60°C +Intense+Max speed (level 3)
standard 40 °C cotton program ⁵⁾	Cotton/Standard+40°C +Intense+Max speed (level 3)	Cotton/Standard+40°C +Intense+Max speed (level 3)	Cotton/Standard+40°C +Intense+Max speed (level 3)
Program time of cotton 60°C, full load (min)	168	168	178
Program time of cotton 60°C, partial load(min)	168	168	178
Program time of cotton 40°C, partial load (min)	148	148	158
Duration of the left-on mode (min) ⁶⁾	-	-	-
Airborne acoustical noise (washing/spinning)(dB(A)) ⁷⁾	58/77	58/77	57/77
Type	freestanding	freestanding	freestanding

¹⁾ Based on 220 standard washing cycles for cotton programmes at 60°C and 40°C at full and partial load, and the consumption of the low-power modes. Actual energy consumption will depend on how the appliance is used.

²⁾ Based on 220 standard washing cycles for cotton programmes at 60 °C and 40°C at full and partial load. Actual water consumption will depend on how the appliance is used.

³⁾ Class G is the least efficient and Class A is the most efficient.

⁴⁾ Based on the standard 60°C cotton program at full load and the standard 40°C cotton program at partial load

⁵⁾ "standard 60°C cotton program" and "standard 40°C cotton program" are the standard washing programmes to which the information in the label and fiche relates. These programmes are suitable to clean normally soiled cotton laundry and they are the most efficient programmes in terms of combined energy and water consumption

⁶⁾ In case there is a power management system

⁷⁾ Based on the standard 60°C cotton program at full load