

SFP9302TX

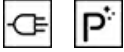

| | |
|-----------------|-------------------|
| Category | 90cm |
| Product Family | Oven |
| Power supply | Electric |
| Heat source | Electric |
| Cooking method | Thermo-ventilated |
| Cleaning system | Pyrolytic |
| EAN code | 8017709325466 |



Aesthetics

| | | | |
|--------------------------|-----------------|------------------------|--------------------------|
| Aesthetics | Classic | Serigraphy type | Symbols |
| Colour | Stainless steel | Door | With 2 horizontal strips |
| Finishing | Fingerproof | Handle | Classic |
| Design | Flat | Handle Colour | Stainless steel |
| Material | Stainless steel | Logo | Embossed |
| Type of steel | Brushed | Control knobs | Classic |
| Glass Type | Eclipse | Controls colour | Steel effect |
| Serigraphy colour | Black | | |











Controls

| | | | |
|--|-----------|------------------------|-----------------------|
|  | | | |
| Display name | EvoScreen | Control setting | Knobs & touch buttons |
| Display technology | LCD | No. of controls | 2 |







Programs / Functions

| | |
|---------------------------------|----|
| No. of cooking functions | 10 |
|---------------------------------|----|

Traditional cooking functions

| | | |
|--|--|---|
|  Static |  Fan assisted |  Circulaire |
|  Turbo (circulaire + bottom + upper + fan) |  ECO |  Large grill |
|  Fan grill (large) |  Base |  Circulaire + bottom |
|  Pizza | | |

Other functions

| | | |
|---|---|--|
|  Defrost by time |  Proving |  Stone cooking |
|  BBQ |  Air-Fry |  Sabbath |

Cleaning functions

| |
|--|
|  Pyrolytic |
|--|

Options



| | | | |
|-------------------------------------|---------------------------------------|-----------------------------|---|
| Time-setting options | Delay start and automatic end cooking | Other options | Keep warm, Eco light, Brightness, Tones |
| Minute minder | Yes | Showroom demo option | Yes |
| Controls Lock / Child Safety | Yes | Rapid pre-heating | Yes |

Technical Features



| | | | |
|-------------------------------|---------|--|------------------|
| Minimum Temperature | 30 °C | Heating suspended when door is opened | Yes |
| Maximum temperature | 280 °C | Door opening type | Standard opening |
| Shelf positions | 5 | Door | Temperate door |
| Double fan | 3 | Removable door | Yes |
| No. of lights | 2 | Full glass inner door | Yes |
| Light type | Halogen | Removable inner door | Yes |
| User-replaceable light | Yes | Total no. of door glasses | 4 |
| Light power | 40 W | Soft Close hinges | Yes |

| | | | |
|---|--------|---|-------------------|
| Light when door is opened | Yes | Cooling system | Tangential |
| Lower heating element power | 1700 W | Cooling duct | Double |
| Upper heating element - Power | 1200 W | Speed Reduction Cooling System | Yes |
| Grill element - power | 1700 W | Usable cavity space dimensions (HxWxD) | 371x724x418 mm |
| Large grill - Power | 2900 W | Temperature control | Electronic |
| Circular heating element - Power | 1550 W | Cavity material | Easy clean enamel |
| Circular heating element 2 - Power | 1550 W | | |

Performance / Energy Label



| | | | |
|--|------------|--|----------|
| Energy efficiency class | A+ | Energy consumption in forced air convection | 5.47 MJ |
| Net volume of the cavity | 115 litres | Energy consumption per cycle in fan-forced convection | 1.52 kWh |
| Energy consumption per cycle in conventional mode | 0.84 kWh | Number of cavities | 1 |
| Energy consumption in conventional mode | 3.02 MJ | Energy efficiency index | 81.6 % |

Accessories Included



| | | | |
|---|---|---|---|
| Chrome shelf | 2 | Grill mesh | 1 |
| Enamelled tray (20mm) | 1 | Telescopic Guide rails, partial Extraction | 1 |
| Extra deep enamelled tray (40mm) | 1 | | |

Electrical Connection

| | | | |
|--------------------------|-----------|----------------------------------|-----------|
| Voltage | 220-240 V | Voltage 2 (V) | 380-415 V |
| Current | 18 A | Frequency (Hz) | 50/60 Hz |
| Nominal power (W) | 4000 W | Power supply cable length | 150 cm |

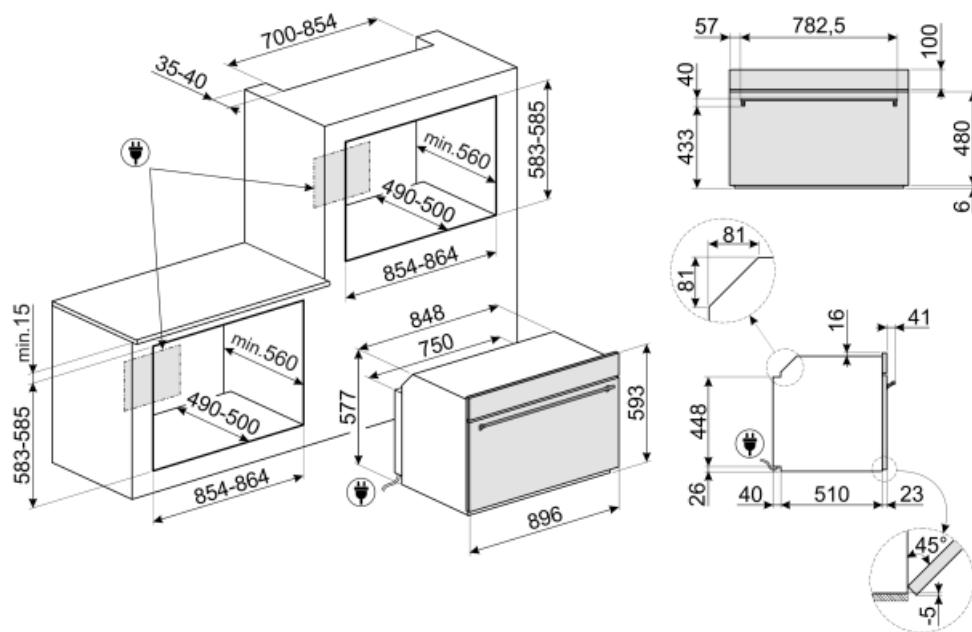

Not included accessories

GTP

**Partially extractable telescopic guides
(1 level)** Extraction: 300 mm Material:
Stainless steel AISI 430 polished



GTT

**Totally extractable telescopic guides
(1 level)** Extraction: 433 mm Material:
Stainless steel AISI 430 polished







































PPR9

Refractory pizza stone without
handles. Squared shaped stone:
L64xH2,3xP37,5 cm Suitable also for
gas ovens, to be put on the griddle.



Symbols glossary

| | | | |
|--|---|---|--|
|  | <p>Triple Fan Technology: The oven is equipped with an exclusive three fan system, which, combined with the increased power of the motors, enables excellent cooking performance. The two large side fans distribute the air around the outer perimeter of the cavity while the smaller central fan increases ventilation by creating a vertical vortex of heat. Accordingly, the temperature within the cavity is uniform, allowing food to be cooked evenly on all five levels, like in professional kitchens.</p> |  | <p>A+: Energy efficiency class A+ helps to save up to 10% energy compared to class A. Maximum performance with minimum consumption is guaranteed.</p> |
|  | <p>Child lock: some models are fitted with a device to lock the programme/cycle so it cannot be accidentally changed.</p> |  | <p>Air cooling system: to ensure a safe surface temperatures.</p> |
|  | <p>Defrost by time: with this function the time of thawing of foods are determined automatically.</p> |  | <p>Quadruple glazed: Number of glazed doors.</p> |
|  | <p>Automatic lighting switches off: for greater energy savings, the lighting switches off automatically after one minute from the start of cooking.</p> |  | <p>Electric</p> |
|  | <p>Enamel interior: The enamel interior of all Smeg ovens have a special antacid lining which helps keep the interior clean by reducing the amount of cooking grease adhering to it.</p> |  | <p>Fan with upper and lower elements: The elements combined with the fan aim to provide more uniform heat, a similar method to conventional cooking, so pre-heat is required. Most suitable for items requiring slow cooking methods.</p> |
|  | <p>Upper and lower element only: a traditional cooking method best suited for single items located in the centre of the oven. the top of the oven will always be hottest. Ideal for roast, fruit cakes, bread etc.</p> |  | <p>Lower heating element only: This function is ideal for foods that require extra base temperature without browning, e.g. pastry dishes, pizza. Also suitable for slow cooking of stews and casseroles.</p> |
|  | <p>Circulaire with lower element: The addition of the lower element adds extra heat at the base for food which requires extra cooking.</p> |  | <p>Circulaire: The combination of the fan and circular element around it gives a hot air cooking method. This provides many benefits including no preheat if cook time is more than 20 minutes, no flavour transfer when cooking different foods at the same time, less energy, and shorter cook times. Good for all types of food.</p> |
|  | <p>ECO: The combination of the grill, fan and lower element is particularly suitable for cooking small quantities of food.</p> |  | <p>Grill element: Using of grill gives excellent results when cooking meat of medium and small portions, especially when combined with a rotisserie (where possible). Also ideal for cooking sausages and bacon.</p> |

- | | |
|--|---|
|  <p>Fan with grill element: The fan reduces the fierce heat from the grill, providing an excellent method of grilling various foods, chops, steaks, sausages etc. giving even browning and heat distribution, without drying out the food. The top two levels recommended for use, and the lower part of the oven can be used to keep items warm at the same time, an excellent facility when cooking a grilled breakfast. Half grill (centre portion only) is ideal for small quantities of food.</p> |  <p>Pizza function: The simultaneous operation of three elements ensures an optimum cooking facility when used with the Smeg pizza stone.</p> |
|  <p>Circulaire with upper and lower elements: The use of the fan with both elements allows food to be cooked quickly and effectively, ideal for large joints that require thorough cooking. It offers a similar result to rotisserie, moving the heat around the food, instead of moving the food itself, enabling any size or shape to be cooked.</p> |  <p>All glass inner door: All glass inner door, a single flat surface which is simple to keep clean.</p> |
|  <p>The inner door glass: can be removed with a few quick movements for cleaning.</p> |  <p>Keep warm: This function allows you to keep precooked foods warm.</p> |
|  <p>Side lights: Two opposing side lights increase visibility inside the oven.</p> |  <p>Pyrolitic: Pyrolitic cleaning cycles can be selected as necessary to automatically clean the oven interior.</p> |
|  <p>Air at 40°C provides the perfect environment for proving yeast type dough mixes. Simply select the function and place dough in the cavity for allotted</p> |  <p>Rapid preheat: The rapid preheat function can be used to reach the selected temperature in just a few minutes.</p> |
|  <p>Sabbath: This function allows you to cook food whilst respecting the provisions of the Jewish day of rest.</p> |  <p>The oven cavity has 5 different cooking levels.</p> |
|  <p>Soft close: all models are equipped with advanced function of smooth closing of the door, which allows the device to close smoothly and quietly.</p> |  <p>Telescopic rails: allow you to pull out the dish and check it without having to remove it from the oven entirely.</p> |
|  <p>Electronic control: Allows you to maintain temperature inside the oven with the precision 2-3 ° C. This enables to cook meals that are very sensitive to temperature changes, such as cakes, souffles, puddings.</p> |  <p>The capacity indicates the amount of usable space in the oven cavity in litres.</p> |
|  <p>...</p> |  <p>Dedicated cooking function for the double sided plate BBQ. Suitable for recreating succulent and crispy dishes in the oven with the typical taste of g</p> |
|  <p>Dedicated cooking function for the Air fryer rack AIRFRY . Ideal for recreating traditional frying in the oven, but with fewer calories and less fat.</p> |  <p>Dedicated cooking function for the rectangular refractory stone PPR2 Dimensions Ideal for cooking pizzas with the same results as a typical wood-fire</p> |