

SO4301M0N

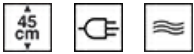

Category	45cm compact
Product Family	Oven
Power supply	Electric
Heat source	Electric
Cooking method	Microwave with grill
Galileo cavity	Micro + grill
EAN code	8017709315542



Aesthetics

Aesthetics	Classic	Serigraphy colour	Silver
Colour	Black	Serigraphy type	Symbols
Finishing	Matte	Door	With 2 horizontal strips
Design	Flat	Handle	Classic
Material	Stainless steel	Handle Colour	Black
Type of steel	Brushed	Logo	Embossed
Glass Type	Eclipse		

Controls



Display name	CompactScreen	No. of controls	2
Display technology	LCD	Control knobs	Classic
Control setting	Control knobs	Controls colour	Black

Programs / Functions

No. of cooking functions 4
 Traditional cooking functions



Microwave functions

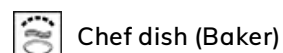

Other functions



Defrost by time

Options



Time-setting options	Delay start and automatic end cooking	Controls Lock / Child Safety	Yes
Minute minder	Yes	Other options	Keep warm
Timer	1	Showroom demo option	Yes

Technical Features



Minimum Temperature	50 °C	Door opening type	Standard opening
Maximum temperature	250 °C	Door	Temperate door
Shelf positions	2	Total no. of door glasses	3
Shelves type	Metal racks	Microwave stops when door is opened	Yes
Tilting grill	Yes	Safety Thermostat	Yes
No. of lights	1	Cooling system	Tangential
Light type	Halogen	Cooling duct	Single
Light power	40 W	Usable cavity space dimensions (HxWxD)	212x462x407 mm
Light when door is opened	Yes	Temperature control	Electronic
Grill element - power	1500 W	Cavity material	Easy clean enamel
Heating suspended when door is opened	Yes	Microwave screen protection	Yes

Performance / Energy Label



Net volume of the cavity	40 litres	Microwave effective power	800 W
Number of cavities	1		

Accessories Included

Chrome shelf	1
---------------------	---

Electrical Connection

Voltage	220-240 V	Frequency (Hz)	50 Hz
Current	13 A	Power supply cable length	115 cm
Nominal power (W)	3000 W		

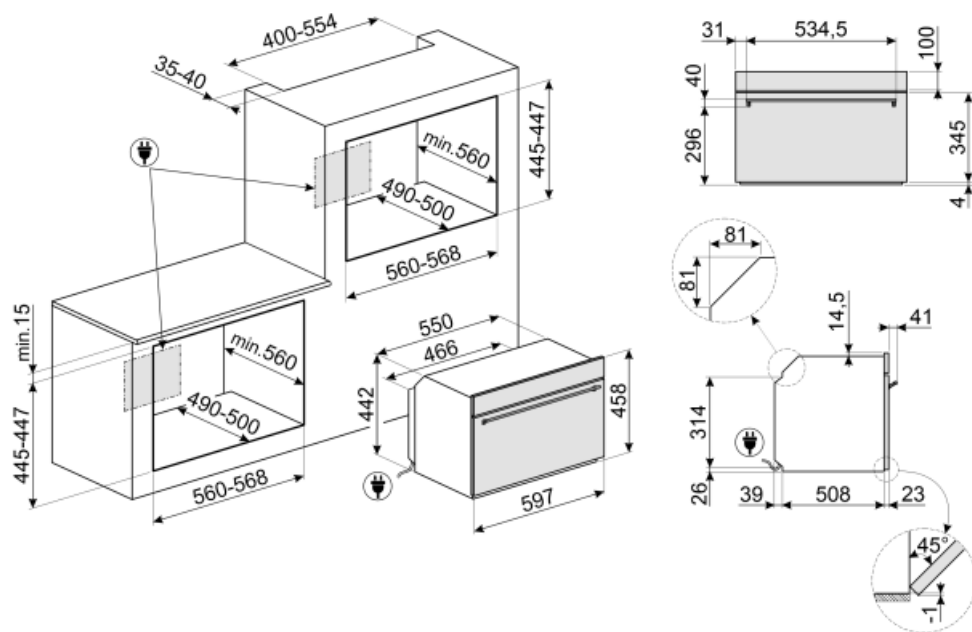

Not included accessories

AIRFRY

Air fryer rack AIRFRY . Ideal for recreating traditional frying in the oven, but with fewer calories and less fat. It allows you to cook quickly and simply dishes such as French fries, fried vegetables and fish, ensuring perfect browning and crispiness.





















STONE

Rectangular refractory stone. Ideal for cooking pizzas with the same results as a typical wood-fired oven. Can also be used for baking bread, focaccias and other recipes such as pies, flans or biscuits Dimensions:L42 x H1,8 x P37,5 cm.



Symbols glossary

 <p>Child lock: some models are fitted with a device to lock the programme/cycle so it cannot be accidentally changed.</p>	 <p>Microwave energy shortens cooking times dramatically and produces energy savings.</p>
 <p>Air cooling system: to ensure a safe surface temperatures.</p>	 <p>Defrost by time: with this function the time of thawing of foods are determined automatically.</p>
 <p>...</p>	 <p>Triple glazed doors: Number of glazed doors.</p>
 <p>Electric</p>	 <p>Enamel interior: The enamel interior of all Smeg ovens have a special antacid lining which helps keep the interior clean by reducing the amount of cooking grease adhering to it.</p>
 <p>Crisper: The simultaneous operation of the microwave, grill and crisper plate (once pre-heated) allows the food to go crispy and golden, ideal for cooking Pizza etc</p>	 <p>Grill element: Using of grill gives excellent results when cooking meat of medium and small portions, especially when combined with a rotisserie (where possible). Also ideal for cooking sausages and bacon.</p>
 <p>Microwave: Penetrating straight into the food, microwaves cook very quickly and with considerable energy savings. Suitable for cooking without fat, they are also able to thaw and heat food without altering its original appearance and aroma. The microwave function can also be combined with conventional functions with all the resulting advantages. Ideal for all types of food.</p>	 <p>Microwave + grill element: The use of the grill results in a perfect browning of the surface of the food. The action of microwaves allows instead of cooking in a short time the internal part of the food.</p>
 <p>Compact appliances with a height of 45 cm - perfect solution to meet the functional requirements of kitchen sets of small height. Available in several types and in different styles.</p>	 <p>Keep warm: This function allows you to keep precooked foods warm.</p>
 <p>Side lights: Two opposing side lights increase visibility inside the oven.</p>	 <p>The oven cavity has 2 different cooking levels.</p>
 <p>Electronic control: Allows you to maintain temperature inside the oven with the precision 2-3 ° C. This enables to cook meals that are very sensitive to temperature changes, such as cakes, souffles, puddings.</p>	 <p>Tilting grill: the tilting grill can be easily unhooked to move the heating element and clean the roof of the appliance in one simple step.</p>
 <p>The capacity indicates the amount of usable space in the oven cavity in litres.</p>	