



Instructions for use

OVEN

OP8637A / BO6PY4I3-42
OP8637S / BO6PY4I3-42
OP8637A1 / BO6PY4I3-42
OP8637B / BO6PY4I3-42

Pictograms used



Important information



Tip

CONTENTS

Your oven

Introduction	4
Description	5
Guide rails/Telescopic guide rails	5
Accessories	6
Door	7
Cooling fan	7
Control panel	8

First use

Before using the appliance for the first time	9
---	---

Use

Switching on and settings	10
Oven settings	13
Choosing the settings	17
Selecting additional functions	19
Starting the cooking process	21
Switching off the oven	21

Operation

Culisensor	22
------------	----

Maintenance

Cleaning the oven	24
Removing and cleaning the guide rails.	24
Removal and installation of the oven door	25
Removing the oven window	26
The Cleaning function (pyrolysis)	27
Replacing the oven lamp	28

Malfunctions

General	29
---------	----

Environmental aspects

Disposal of the appliance and packaging	31
---	----

Introduction

Congratulations on the purchase of this ASKO oven. This product is designed to offer optimum user-friendliness. The oven has a wide range of settings enabling you to select the correct cooking method every time.

This manual shows how you can best use this oven.

In addition to information about operating the oven, you will also find background information that may be useful when using the appliance.



Please read the separate safety instructions carefully before using the appliance!

Read this manual before using the appliance and keep it in a safe place for future use.

Installation instructions are supplied separately.

YOUR OVEN

Description

1. Control panel
2. Rack levels
3. Oven door
4. Handle

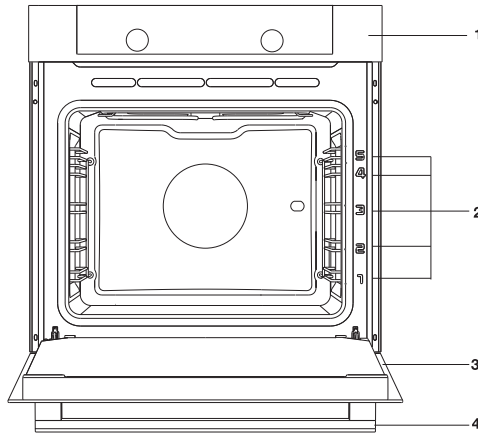

Guide rails/Telescopic guide rails





- The oven has four or five guide rails (Level 1 to 4/5), depending on the model. Level 1 is mainly used in combination with bottom heat. The two upper levels are mainly used for the grill function.
- Place the oven rack, baking tray or steam dish in the gap between the guide rail sliders.
- A number of shelf levels can have fully-retractable telescopic guide rails, depending on the model.
 - Pull the telescopic guide rails out of the oven cavity completely and place the oven rack / baking tray / steam dish on them. Then slide the oven rack / baking tray / steam dish on the telescopic guide rails, back into the oven cavity.
 - Only close the oven door when the telescopic guide rails have been returned completely back into the oven cavity.

YOUR OVEN

Accessories

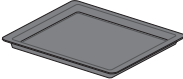
Your appliance is accompanied by a range of accessories, depending on the model. Only use original accessories; they are specially suited to your appliance. Be sure that all the accessories that are being used are able to withstand the temperature settings of the chosen oven function.

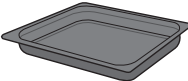
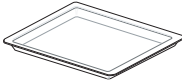
Note: not all accessories are suitable/available for every appliance (it may also differ by country). When purchasing, always provide the exact identification number of your appliance. Please see the sales brochures or check online for more details about optional accessories.

Accessories that can be supplied with your appliance (depending on the model)	
	Enamelled baking tray; to be used for pastries and cakes. <ul style="list-style-type: none">• Do not use the enamelled baking tray for microwave functions!• Suitable for pyrolysis cleaning.
	Oven rack; mainly used for grilling. A steam dish or pan with food can also be placed on the oven rack. <ul style="list-style-type: none">• The oven rack is equipped with a safety peg. Lift the rack slightly at the front to slide it out of the oven.• Do not use the oven rack for microwave functions!
	Deep enamelled baking tray; to be used for roasting meat and baking moist pastry. It can also be used as a drip tray. Place the deep baking tray into the first level for use as a drip tray during grilling. <ul style="list-style-type: none">• Do not use the deep enamelled baking tray for microwave functions!• Suitable for pyrolysis cleaning.
	Glass baking tray; for microwave and oven use. <ul style="list-style-type: none">• NOT suitable for pyrolysis cleaning.
	Culisensor; can be used to measure the core temperature of the dish. When the desired temperature is reached, the cooking process will be stopped automatically.

YOUR OVEN

Door

- The door switches interrupt the operation of the oven when the door is opened during use. The oven continues operating when the door is closed.
- This oven has a 'Soft close door system'. When closing the oven door, this system dampens the movement, from a certain angle, and silently closes the oven door.

Cooling fan

- The appliance is equipped with a cooling fan that cools the casing and control panel.

YOUR OVEN

Control panel

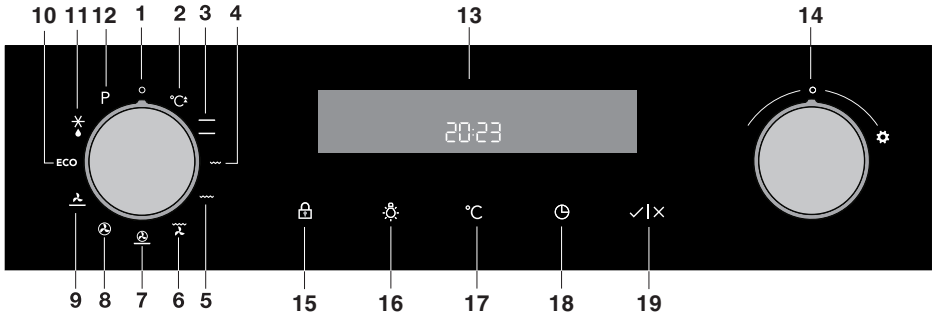

1. Off
2. Quick preheat
3. Top heat + bottom heat
4. Small grill
5. Large grill
6. Grill with fan
7. Hot air + bottom heat
8. Hot air
9. Bottom heat with fan
10. ECO cooking
11. Defrosting
12. Pyrolysis
13. Display (cooking information and timer)
14. Selection dial
15. Child lock
16. Oven lamp
17. Temperature
18. Timer
19. Start/Stop



Note:

For the best touch response, touch the buttons with the main part of your fingertip. Every time you press a button during use, a short signal will sound.

FIRST USE

Before using the appliance for the first time

- Upon receiving the appliance, remove all parts, including any transport equipment, from the oven.
Clean all accessories and utensils with warm water and regular detergent. Do not use any abrasive cleaners.
- When the oven heats up for the first time, the characteristic smell of a new appliance will be emitted. Ventilate the room thoroughly during the first use.

Switching on and settings

After connecting your appliance or after an extended power outage, 12:00 will flash on the display and the symbol will light up.

Set the time of day.

SETTING THE CLOCK



Rotate the SETTINGS KNOB (-/+) and first set the minutes; then, the cursor will switch to hours. After three seconds, the settings will be saved.



Turning the knob farther to the right or to the left will change the settings more quickly.

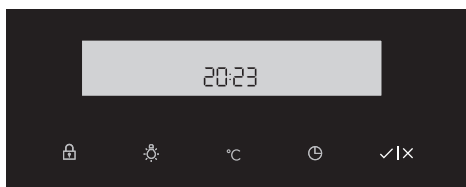

Confirm by pressing START/ STOP. If nothing is pressed within the next three seconds, the setting will be stored automatically.



The oven will also work if the clock is not set. However, timer functions are not available in this case (see chapter: SETTING THE TIMER FUNCTIONS).

After a few minutes of idling, the appliance will switch to standby mode.

CHANGING THE CLOCK SETTING

Clock settings may be changed when no timer function is activated.

Press the key to  set the current time. Confirm by pressing START/ STOP.

USE

SETTINGS

To change the settings, rotate the setting knob to the right and hold it for three seconds. Press the start/sop icon to scroll through respective settings or parameters. To change a parameter, rotate the setting knob to the right or to the left.

BRIGHTNESS LEVEL

Select between three different options of brightness levels. Mid level is pre-set. Levels can be set by rotate knob.



Brightness level low

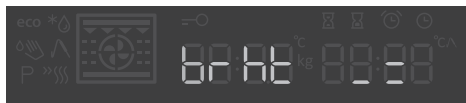

Brightness level mid



Brightness level max

SOUND LEVEL

Mid level is pre-selected. Sound levels can be set by rotate knob.



Volume level low



Pre-set mid sound level



Volume level max



Volume level off

END

By pressing the start/stop icon, user can go out of settings menu back to standby mode. You can go out of settings manu also if you hold selection knob on the left for 3 sec, or it you turn the system knob.







To change the settings, rotate the setting knob to the right and hold it for three seconds. Press the start/sop icon to scroll through respective settings or parameters. To change a parameter, rotate the setting knob to the right or to the left.







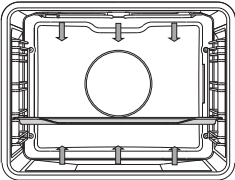

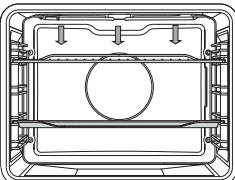

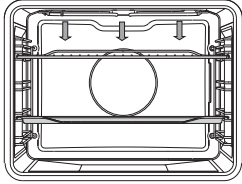

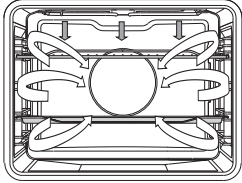

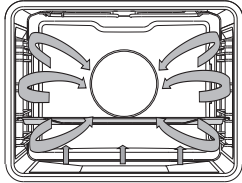
After a power outage or after the appliance is switched off, the additional function settings will remain stored for no more than a few minutes. Then, all settings, except for the acoustic signal and child lock will be reset to factory defaults.

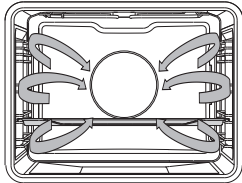
Oven settings

Use the table to select the right oven function. Also consult the cooking instructions on the food packaging.

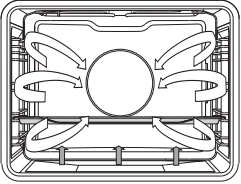
Function/ Recommended temp. °C	Description	
 <p>160 °C</p>	<p>Quick preheat</p> <p>Use this function to heat the oven quickly to the desired temperature.</p> <p>This function is not suitable for cooking food!</p> <ul style="list-style-type: none"> • Turn the 'oven function dial' to the 'quick preheat' position. <i>The prior set temperature will be displayed.</i> <i>You can alter this temperature.</i> <p>Note:</p> <p>Preheat will begin after you have started the oven using the 'start/stop' button. Preheat is complete when the set temperature is reached and a signal sounds.</p>	
 <p>200 °C</p>	<p>Top heat + bottom heat</p> <p>Heat is generated by the heating elements at the top and bottom of the appliance. This setting is suitable for traditional baking and roasting.</p> <ul style="list-style-type: none"> • The baking tray or the grill rack is usually placed at level 2. • Preheating is recommended. 	
 <p>240 °C</p>	<p>Small Grill</p> <p>Food is heated by the grill element.</p> <ul style="list-style-type: none"> • For grilling, the grill rack is usually placed at level 4 and the baking tray at level 2. • Keep an eye on the cooking process. At high temperatures, meat can burn quickly. • Preheat the oven for 5 minutes. 	

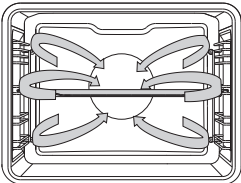
Function/ Recommended temp. °C	Description	
 240 °C	<p>Large grill</p> <p>The heat comes from the top element and the grill element. This setting is particularly useful for dishes and baked food that require a real bottom crust or browning. Use this just before the end of the baking or roasting time.</p> <ul style="list-style-type: none"> • For grilling place the oven rack on the fourth guide rail level and the baking tray on the second guide rail level. 	
 170 °C	<p>Grill + fan</p> <p>The fan distributes the heat generated from the top heating element. You can use this function for grilling meat, fish, poultry and vegetables. It gives food a crispy texture without it needing to be turned over.</p> <ul style="list-style-type: none"> • For grilling, the grill rack is usually placed at level 4 and the baking tray at level 2. • Keep an eye on the cooking process. At high temperatures, meat can burn quickly. • Preheat the oven for 5 minutes. 	
 200 °C	<p>Hot air + bottom heat</p> <p>Food is heated using a combination of hot air and bottom heat. This setting is used for a crispy and browned result.</p> <ul style="list-style-type: none"> • The baking tray or the grill rack is usually placed at level 2. • Preheating is recommended. 	
 180 °C	<p>Hot air</p> <p>Food is heated by hot air from a fan and the heating element at the back of the oven. This setting uses even heating and is ideal for baking.</p> <ul style="list-style-type: none"> • Place the tray at level 2. • Preheating is recommended. 	

Function/ Recommended temp. °C	Description	
 180 °C	<p>Bottom heat + fan</p> <p>The bottom element heats the dish and the heat is distributed by the fan. This setting is used for baking yeasted pastry and preserving fruit and vegetables.</p> <ul style="list-style-type: none"> • Place the tray at level 2. • Preheating is recommended. 	
 180 °C	<p>ECO cooking</p> <p>In this mode, power consumption during the cooking process is optimized. This mode is used for roasting meat and baking pastry. By making use of the residual heat this setting gives a low energy consumption (energy class in accordance with EN 60350-1). On this setting the oven does not display the actual temperature in the oven.</p> <ul style="list-style-type: none"> • Place the tray at level 3. 	
	<p>Defrosting</p> <p>In the defrost function the fan circulates the air. No heat elements are switched on. Use this function for slow defrosting of frozen dishes (cakes, biscuits, cookies, bread, bread rolls and frozen fruit).</p> <ul style="list-style-type: none"> • If desired, set a different defrost time by pressing the 'timer button' and setting the time using the 'selection dial'. • Turn the food over after half the defrosting time has elapsed; stir the food or break up large pieces if these are frozen together. 	
	<p>Pyrolysis</p> <p>This function allows automatic cleaning of the oven cavity/interior using high temperature (approx. 460 °C), which incinerates the fat residues and other impurities, reducing them to ashes.</p>	

Each oven function has a number of basic or standard settings that you can adjust.



You adjust the settings by pressing the relevant button (before pressing the 'start/stop' button). Certain settings are not available for all programmes; if this is the case you will be alerted by a sound signal.

Adjusting the cooking temperature

- Turn the 'oven function dial' to the desired oven function.
- The selected pictogram will appear on the display and the prior set temperature will flash.
- Press the 'temperature button'. Set the oven to the desired temperature using the 'selection dial'.

Choosing the settings

Each cooking system features basic or default settings which can be adjusted.

Adjust the settings by pressing the relevant key (before pressing the START/STOP key). Some settings are not available with some programs; an acoustic signal will remind you of such cases.

CHANGING THE COOKING TEMPERATURE

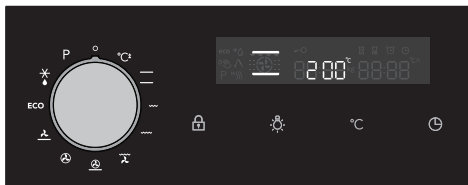

Select the COOKING SYSTEM. Selected icon will appear on the display and PRESET TEMPERATURE will flash.

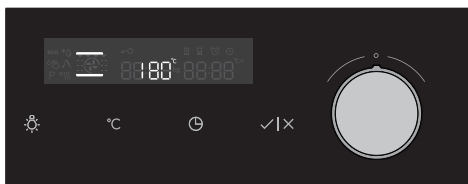

Touch the TEMPERATURE KEY. Rotate the SETTINGS KNOB (-/+) and choose the desired temperature.



Maximum temperature is limited with some systems.

When the appliance is switched on with the START key, the symbol °C flashes on the display until the desired value is reached.

TIMER FUNCTIONS

First rotate the COOKING SYSTEM SELECTOR KNOB; then, set the temperature.

Touch the TIMER key several times to select the symbol.

The icon for the selected timer function will light up and the adjustable cooking start/end time will flash on the display. Other icons are dimly lit.

Press START to start the cooking process. ELAPSED COOKING TIME will be displayed.

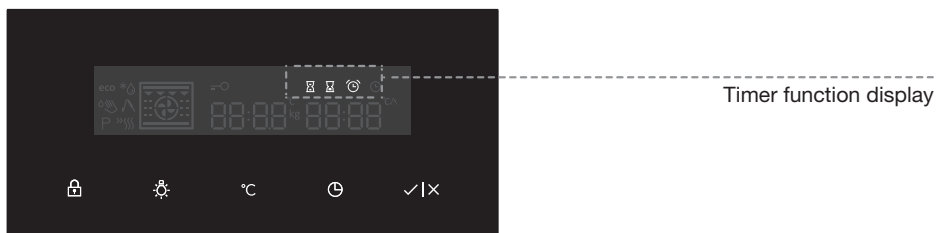

Setting the cooking time

In this mode, you can define the duration of oven operation (cooking time). Set the desired cooking time. First set the minutes, then the hours. Icon and cooking time are displayed on the display unit.



Setting the delayed start

In this mode, you may specify the duration of the cooking process (cooking time) and the time when you wish the cooking process to stop (end time). Make sure the clock is accurately set to current time.

Example:

Current time: noon

Cooking time: 2 hours

End of cooking: 6 pm

First set the OPERATION DURATION (2 hours). Touch the CLOCK button again and select END OF OPERATION. The display automatically shows a flashing sum of the time of day and duration of operation of the oven (14:00).

Set the time for the end of baking (18:00)

Press START to start the cooking process. The timer will wait for the time to start the cooking process and the symbol will be lit up. The oven automatically switches on (14:00) and stops operating and the selected time (18:00).



Setting the minute minder

The minute minder can be used independently of the oven operation. The longest possible setting is 24 hours.

During the last minute, the minute minder is displayed in seconds.



After the set time expires, the oven will automatically stop operating (end of cooking).

An acoustic signal will be heard which you may turn off by touching any key. After one minute, the acoustic signal will be switched off automatically.

All timer functions can be cancelled by setting the time to »0«.

After a few minutes of idling, the appliance will switch to standby mode.

Selecting additional functions

Activate/deactivate the functions by pressing the desired key or a combination of keys.



Some functions are not available with some systems; an acoustic signal will indicate of such cases.



Child lock

Activate it by touching the CHILD LOCK key. The »key« icon will light up on the display. Touch the key again to deactivate the child lock. The icon on the display will disappear.

If the child lock is activated with no timer function engaged (only clock is displayed), then the oven will not operate.

If the child lock is activated after a timer function has been set, then the oven will operate normally; however, it will not be possible to change the settings.

When the child lock is activated, systems (cooking modes) or additional functions cannot be changed. The only possible change is to end the cooking process by rotating the selector knob to »0«.

Child lock will remain active after the oven is switched off. To select a new system, the child lock must first be deactivated.



Oven lighting

Oven lighting is switched on automatically when the door is opened or when the oven is switched on.

After the end of the cooking process, the light will remain on for another minute.

The light inside the oven can be switched on or off by pressing the LIGHT key.

5sek



Acoustic signal

Loudness of the acoustic signal can be set when no timer function is activated (only the time of day is displayed). Press the TEMPERATURE/POWER key and hold it for 5 seconds. Two fully lit bars will appear on the display. Rotate the SETTINGS KNOB (-/+) to choose one of the three volume levels (one, two, or three bars). After three seconds, the setting will be automatically stored and the time of day will appear.

5sek



Decreasing the display contrast

The cooking system selector knob should be on the »0« position. Press the LIGHT key and hold it for 5 seconds. Two fully lit bars will appear on the display. Rotate the SETTINGS KNOB (-/+) to adjust the display dimmer (one, two, or three bars). After three seconds, the setting will be automatically saved.



Standby

Display lighting can be automatically switched off after 10 minutes if it is not used.

Press the KEY + TIMER keys to switch off the display. If a timer function has been activated, then »OFF« and the TIMER icon will appear on the display to indicate the activated function.



After a power outage or after the appliance is switched off, the additional function settings will remain stored for no more than a few minutes. Then, all settings, except for the acoustic signal and child lock will be reset to factory defaults.

Starting the cooking process

Start the cooking process by pressing the START/STOP key and holding it for a while.



Switching off the oven

Turn the COOKING SYSTEM SELECTOR KNOB to position »0«.

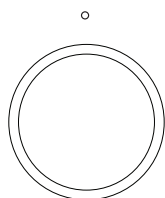

After the end of the cooking process and after the oven has been switched off, declining temperature is displayed down to 50 °C.

All timer settings are also paused and cancelled. Time of day (clock) will be displayed.

After one minute of idling, the appliance will switch to standby mode.



After the use of the oven, some water may be left in the condensate channel (underneath the door). Wipe the channel with a sponge or a cloth.

OPERATION

Culisensor

If the culisensor is plugged in, the culisensor screen will be shown and a small culisensor icon will appear. The oven operates until the food core reaches the set temperature. The core temperature is measured by means of the temperature probe.

1. Screw the metal cover from the connection point (front top corner of the right side wall).
2. Put the culisensor plug in the connection and insert the culisensor completely into the food.

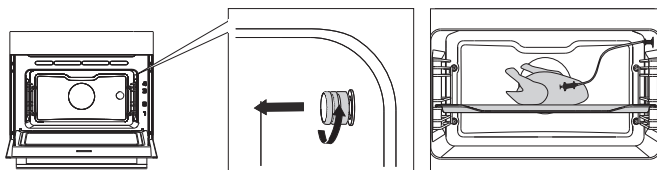

The display will show the culisensor screen and icon.

3. Set the function and temperature. Instead of the time, you need to set the core temperature (between 30 -100 °C).
4. Start the progress by pressing the 'start/stop' button.
5. During cooking, the rising temperature of the core will be displayed (the desired core temperature may be adjusted during the cooking process).
6. When the set core temperature is reached, the cooking process will stop. An acoustic signal will sound, which you may turn off by pressing any button. After one minute, the acoustic signal will be switched off automatically. The current time appears on the display.



- **Always place the culisensor's entire metal sensor in the dish.**
- **Please note! After the cooking process always replace the metal cap on the culisensor's connection.**
- **Only use the culisensor in your oven.**
- **Ensure that the culisensor does not come into contact with the heating element during cooking.**
- **The culisensor will be extremely hot after the cooking process. Be careful! Avoid burns.**

Recommended core temperature values

Beef		
Fillet/sirloin	medium	55 - 58 °C
Roast beef	medium	55 - 60 °C
Round steak	well-done	85 - 90 °C
Roast beef	well-done	80 - 85 °C
Stewed beef	well-done	90 °C
Pork		

OPERATION

Hoof/leg	well-done	75 °C
Hoof/leg	slightly pink	65 - 68 °C
Pork loin	slightly pink	65 - 70 °C
Pork shoulder	well-done	75 °C
Pork belly/stuffed	well-done	75 - 80 °C
Pork belly	well-done	80 - 85 °C
Roast pork hoof	well-done	80 - 85 °C
Pork hoof	well-done	80 - 85 °C
Cooked ham	very tender	64 - 68 °C
Kassel ribs	well-done	65 °C
Breaded ham		65 - 68 °C
Veal		
Veal loin	slightly pink	58 - 65 °C
Veal hoof/leg of veal	well-done	78 °C
Fried kidneys	well-done	75 - 80 °C
Roast veal/shoulder	well-done	75 - 80 °C
Leg of veal	well-done	75 - 78 °C
Mutton		
Mutton loin	pink	65 - 70 °C
Mutton loin	well-done	80 °C
Mutton hoof	pink	70 - 75 °C
Leg of mutton		82 - 85 °C
Lamb		
Leg of lamb	pink	60 - 62 °C
Leg of lamb	well-done	68 - 75 °C
Lamb loin	pink	54 - 58 °C
Lamb loin	well-done	68 - 75 °C
Lamb shoulder	well-done	78 - 85 °C
Poultry		
Chicken	well-done	85 °C
Goose/Duck	well-done	90 - 92 °C
Turkey	well-done	80 - 85 °C
Pastries etc		
Pastries		72 - 85 °C
Terrines		60 - 70 °C
Fish		
Salmon	soft	60 °C
Fish fillet		62 - 65 °C
Entire fish		65 °C
Terrine		62 - 65 °C

Cleaning the oven

Clean the oven regularly to prevent fat and leftover food from accumulating, especially on interior and exterior surfaces, the door and seal.

- Clean exterior surfaces with a soft cloth and soapy warm water. Wipe afterwards with a clean, damp cloth and dry the surfaces.
- Remove splashes and stains on the interior surfaces with a soapy cloth. Wipe afterwards with a clean, damp cloth and dry the surfaces.
- Clean the interior of the oven



Important

- Take care that NO water enters the vents.
- NEVER use abrasive cleaning materials or chemical solvents.
- ALWAYS ensure that the door seal stays clean.

This prevents accumulation of dirt and allows you to close the door properly.

Removing and cleaning the guide rails.

Only use conventional cleaners to clean the guides.

- Remove the screws using a screwdriver.
- Remove the guides from the holes in the back wall.

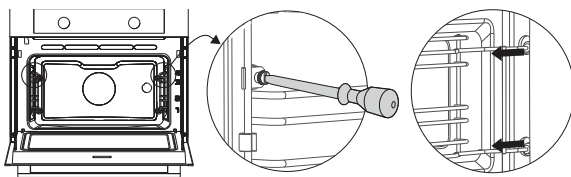

Removal and installation of the oven door

Keep your fingers away from the hinges of the oven door. The hinges are spring loaded and can cause injury if they spring back.

Make sure that the hinge latches are applied correctly to lock the hinges.

Remove the oven door

1. Open the door to the fully open position.
2. Lift both hinge latches (A) and pull them towards the oven door (B).
The hinges will be locked in the 45° position.
3. Gently close the door until it reaches a 45° angle.
4. Remove the door by lifting and tilting it towards the oven (C).
The hinges need to come out of the slots in the oven.

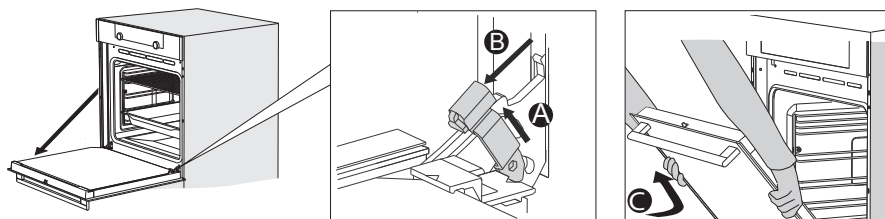

Install the oven door

5. Hold the door at an angle of approximately 45° in front of the oven.
6. Insert the hinges into the slots and make sure they are both positioned correctly.
7. Open the door to the fully open position.
8. Lift both hinge latches and move them towards the oven.
9. Gently close the oven door and make sure that it closes correctly.
If the door does not open or close correctly, then make sure that the hinges are positioned correctly in their slots.

MAINTENANCE

Removing the oven window

The glass in the oven door can be cleaned from the inside, but you do need to remove the glass from the door to do this. First remove the oven door (see chapter 'Removing the oven door').

- Lift the brackets on the left and right side of the door upwards slightly (to marker 1 on the bracket) and pull this away from the glass slightly (to marker 2 on the bracket).
- Grasp the glass at the bottom and gently lift this upwards to remove it from the support.
- The inner third glass (depending on the model) can be removed by lifting this carefully and removing it. Also remove the rubber seals around the glass.

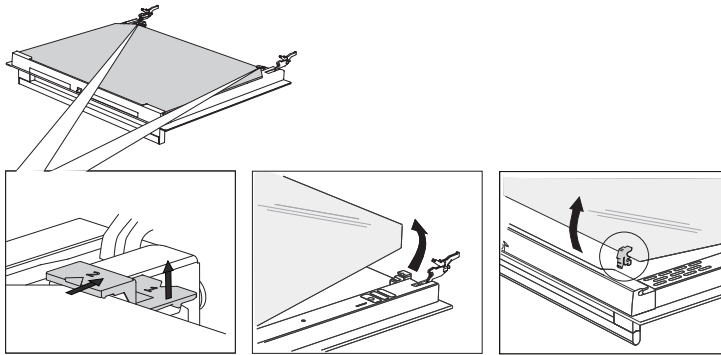

To replace the glass pane, observe the reverse order. The markings (semicircle) on the door and the glass pane should overlap.

The Cleaning function (pyrolysis)

Instead of cleaning manually, you can clean the oven space or an enamelled baking tray using the 'Pyrolysis' oven feature. During pyrolysis the oven space is heated to a very high temperature. Contaminants that are present incinerate at this high temperature and only ash remains.



With average use of the oven, we recommend running the pyrolysis function once per month.



Caution!

- **First**, remove all accessories and guide rails / telescopic guide rails from the oven (see 'Removing and cleaning the guide rails').
- Then remove any remaining food from the oven space and wipe the space with a damp cloth. Chunks of food and fat may ignite during the pyrolysis process. **Fire hazard!**



Note! The oven space and an enamelled baking tray cannot be cleaned at the same time using the pyrolysis function. If you want to clean an enamelled baking tray using pyrolysis, then do this first (the oven space can become dirty due to the cleaning of the baking tray). Insert one baking tray at a time. After that, the oven space can be cleaned.



Caution! Do NOT clean the glass baking tray using the 'Pyrolysis' oven feature.

Starting the Pyrolysis function

1. Make sure the oven space is completely empty and no chunks of food and fat are present!
 2. If you want to clean an enamelled baking tray first, place the special pyrolysis guide rails in position. Wipe the baking tray with a damp cloth and slide the baking tray into the oven on Level 2.
 - Remove these special pyrolysis guide rails after the cleaning process.
 3. Turn the 'oven function dial' to 'Pyrolysis'. The cleaning intensity level and time are displayed.
 4. To choose the desired cleaning intensity level, press the 'temperature button' and turn the 'selection dial' to select one of three cleaning levels (one, two or three bars lit).
 5. After a certain period of time, oven door will be automatically locked for your safety. The key symbol will appear on the display.
- Unpleasant smell may be emitted from the oven during the cleaning process.
 - When the oven has cooled down, wipe it with a damp cloth.
Wipe the oven door and the adjacent surfaces in the gasket area. Do not rub the gasket.

MAINTENANCE



Please note: Do not attempt to open the oven door while the automatic cleaning programme is in progress. The programme may be terminated. Risk of burns!

Replacing the oven lamp



The lamp in this household appliance is only suitable for illumination of this appliance. The lamp is not suitable for household room illumination.

The lamp (E14, 230-240 V, 25 W, 300 °C) is a consumer item and therefore does not fall under the guarantee. First remove the baking tray, oven rack and guide rails.



Cut the power to the appliance by removing the plug from the socket or switching off the fuse in the fuse box!

Please note: the lamp can be very hot! Use protection to remove the lamp.

Rear wall lamp

1. Turn the cover to the left to remove it.
2. Turn the bulb out of the fitting.

Side wall lamp

3. Use a flat-blade screwdriver to snap and remove the lamp cover from the holder.
4. Be careful not to damage the enamel.
5. Turn the bulb out of the fitting.

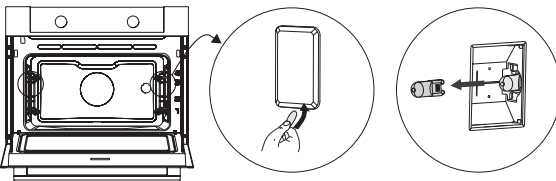

MALFUNCTIONS

General

Try the solutions below if you have problems with your oven. You could save yourself the time and effort of an unnecessary phone call to customer services.

The food is not cooked

- Check whether the timer has been set and you have pressed the 'start button'.
- Close the door properly.
- Check whether a fuse has blown and whether a circuit breaker has been activated.

Food is overcooked or undercooked

- Check whether the correct cooking time has been set.
- Check whether the temperature has been set.

The display will be reset following power failure

- Remove the plug from the socket and put it back in again.
- Set the time again.

There is condensation on the interior of the oven

- This is normal. Wipe the oven clean after use.

The fan keeps working after the oven is switched off

- This is normal. Once the oven has been switched off, the cooling fan may continue to run for a little while.

Air flow can be felt at the door and the exterior of the appliance

- This is normal.

Light reflects on the door and the exterior of the appliance

- This is normal.

Steam escapes from the door or the vents

- This is normal.

Clicking sounds can be heard when the oven is working, particularly in the defrost setting

- This is normal.

MALFUNCTIONS

Storing and repairing the oven

Repairs may only be performed by a qualified service technician.

If maintenance is required, remove the plug from the socket and contact ASKO customer services.

Have the following information to hand when you call:

- The model number and serial number (stated on the inside of the oven door)
- Guarantee details
- A clear description of the problem

Choose a clean, dry place if you have to store the oven temporarily, as dust and moisture can damage the appliance.

Disposal of the appliance and packaging

This product is made from sustainable materials. However, the appliance must be disposed of responsibly at the end of its useful life. The government can provide you with information about this.

The appliance packaging can be recycled. The following materials have been used:

- cardboard;
- polyethylene film (PE);
- CFC-free polystyrene (hard PS foam).

Dispose of these materials responsibly in accordance with legal provisions.



The product has a pictogram of a crossed-out waste container. This indicates that household appliances must be disposed of separately. This means that the appliance may not be processed via the regular waste flow at the end of its useful life. You should take it to a special municipal waste depot or a sales outlet that offers to do this for you.

Collecting household equipment separately prevents harm to the environment and public health. The materials used in manufacturing this appliance can be recycled, which provides considerable savings in energy and raw materials.

Declaration of Conformity

CE We hereby declare that our products satisfy the applicable European Directives, Orders and Regulations, as well as the requirements stated in the referenced standards.



The appliance rating label is located on the inside of the appliance.

When contacting the service department,
have the complete type number to hand.

You will find the addresses and phone numbers of the service organisation on the guarantee card.

 **ASKO**



862798

en (10-22)