

Tefal[®]

IXEO
POWER

ALL-IN-ONE SOLUTION

EN



IXEO POWER QT20XX

Important guidelines

Safety information

- Read the instruction manual carefully before using your appliance for the first time. This product is designed for domestic and indoor use only. Any commercial use, inappropriate use or failure to comply with the instructions, the manufacturer accepts no responsibility and the guarantee will not apply.
- Do not unplug your appliance by pulling on the power cord. Always unplug your appliance:
 - before filling the water tank or rinsing the boiler,
 - before cleaning the appliance,
 - after each use.
- The appliance iron does not work without the scale collector (depending on the model).
- The appliance must be used and placed on a flat, stable and heat-resistant surface. When you place the iron on the iron rest, ensure that the surface on which you place it is stable. Do not place the base unit on the ironing board cover or on a soft surface.
- This appliance is not intended to be used by individuals (including children) with reduced physical, sensory or mental capabilities, or those lacking experience or knowledge, unless they have been given prior instruction on how to safely use the appliance or are under the supervision of a person responsible for their safety.
- Children must be supervised to ensure that they do not play with the appliance.
- This appliance may be used by children aged 8 years and older and by individuals lacking experience or knowledge or with reduced physical, sensory or mental capabilities, provided that they have been thoroughly instructed regarding the use of the appliance, are supervised, and understand the risks involved. Children must not play with the appliance. Cleaning and user maintenance shall not be made by children without supervision. Keep the iron and its power cord out of reach of children under 8 years of age when it is in use or cooling down.

-  The surfaces of your appliance can reach very high temperatures when functioning, which may cause burns. Do not touch the hot surfaces of the appliance (accessible metal parts and plastic parts adjacent to the metallic parts).
- Never leave the appliance unsupervised while it is connected to the mains. Before storing the appliance, once it is unplugged, please wait until it has cooled down completely (around 1 hour).
- It is very important not to use descaling products (vinegar, industrial descalers, etc.) to rinse the boiler, as they may damage it.
- Before emptying the boiler/rinsing the collector (depending on the model), always wait until the appliance has cooled down and has been unplugged for over 2 hours before loosening the drainage/collector cap.
- Caution: If the cap or drainage cap (depending on the model) is damaged, have it replaced by an approved service centre.
- Never fill the appliance directly from the tap.
- The filling, descaling, rinsing and inspection apertures, which are under pressure, must not be opened during use.
- Care should be taken when using the appliance due to emission of steam
- Unplug the appliance during cleaning & filling
- The appliance must not be used if it has been dropped, if it appears to be damaged, if it is leaking or is not working correctly. Do not attempt to dismantle your appliance: take it to an approved service centre to avoid any danger.
- If the power cord or steam cord of your appliance is damaged, it must be replaced by an approved service centre in order to avoid any danger.
- The fabric steamer must not be left unattended while it is connected to the supply mains.
- Keep the fabric steamer and its cord out of reach of children less than 8 years of age when it is energized or cooling down.

- All accessories, consumables and removable parts must be bought only from an approved service centre.
- For your safety, this appliance conforms to all applicable regulations (Low Voltage, Electromagnetic Compatibility and Environment Directives, etc.).
- Your steam generator iron is an electrical appliance: it must be used under normal conditions of use.
- It is equipped with 2 safety systems:
 - a valve to prevent the build-up of pressure, which allows excess steam to escape in the event of the appliance malfunctioning,
 - a thermal fuse to prevent overheating.
- Always plug your appliance:

- into a mains circuit with voltage between 220 V and 240 V (Alternating current only),
 - into a socket outlet with an earth connection.
- Faulty connection can cause irreparable damage to the appliance and will invalidate your guarantee. If you are using an extension cord, ensure that it is correctly rated (16A) with an earth connection, and is fully extended.
- Unwind the power cord fully before plugging it into an earthed plug socket.
 - Never touch the power cord or steam cord with the soleplate of the iron. Do not leave the power or water connection cords close to or in contact with sources of heat or sharp edges.
 - The water in the appliance may still be hot and cause burns even after 2 hours of cooling down. Handle the appliance with care when the cap/collector is removed, particularly when you are emptying it.
 - Your appliance emits steam that may cause burns.
 - Handle the iron with care, particularly when using the vertical steam function.
 - Never steam clothing when it is worn by a person, always steam it on a hanger.
 - Never iron in a seated position with your legs below the ironing board.
 - Never direct the steam towards people or animals.
 - The first time the appliance is used, there may be some fumes and smell but this is not harmful.
 - Never immerse your steam generator iron in water or any other liquid. Never place it under tap water.

What water should I use?

- This appliance has been designed to be used with untreated tap water. If your water is very hard, (hardness above 30°F, or 17°dH or 21°e) use a mixture of 50% tap water and 50% distilled water. In some seaside regions, salt content might be high. In that case, use only water bottle, with low mineral lever
- They are different type of softened water, and most of them can be used in your steam gen. However, some of them, especially the one with chemical components, like salt, might occur white or brown runs. If you face this type of issue, we recommend you to use non-treated tap water or bottled water.
- You should not use water from domestic appliances, with additives (starch, perfume, etc.) , rain water, boiled, filtered, bottled water. Do not use pure distilled nor pure demineralised water. Such water might affect steam attributes and at high temperature generate steam chamber sediment, liable to stain your linen and provoke early appliance aging.

PLEASE RETAIN THIS INSTRUCTION MANUAL



Help protect the environment!

- ① Your appliance contains a number of recoverable or recyclable materials.
- ♻ Take these to a collection centre, or to an approved service centre for processing.

Troubleshooting problems with your steam generator iron

PROBLEMS	CAUSES	SOLUTIONS
Water is dripping from the holes in the soleplate	The water has condensed in the tubes because you are using the steamer for the first time or have not used it for a while.	Press the steam button away from your ironing board until the iron emits steam.
White streaks are dripping from the holes in the soleplate	Your boiler is emitting limescale as it is not rinsed regularly.	Rinse the boiler as instructed in the user manual.
Brown streaks are dripping from the holes in the soleplate and staining the laundry	You are using chemical descaling agents or additives in the water.	Never add any product to the boiler (see the section "What water should I use?")
The soleplate is dirty or brown and may mark the laundry	The iron is being used on too high a temperature.	Clean the soleplate as instructed in the user manual. Use a lower temperature.
The soleplate is scratched or damaged	You have placed your iron flat down on the metal iron rest.	Always place your iron on its iron rest.
The red "WATER" indicator light is flashing*	You have not pressed the "OK" button.	Press the "OK" button located on the control panel until the indicator light goes off.
The "anti-scale" indicator light is flashing*	You have not pressed the "OK" button.	Press the "OK" button located on the control panel until the indicator light goes off.
The steam generator iron will not turn on or the iron indicator light and the "ON-OFF" indicator light will not turn on.*	The "auto-off" system is activated after 30 minutes of non-use and has turned off your steam generator iron.	Press the "ON-OFF" restart button located on the control panel.
The red "WATER" indicator light is flashing and the "ON-OFF" button is not working.*	The appliance has been stored in a cold area (around <10°C)	Unplug the appliance. Leave the appliance for 3 hours until it reaches ambient temperature.

* Depending on the model

If you cannot determine the cause of the problem, consult an approved after sales care service.

1. Product presentation

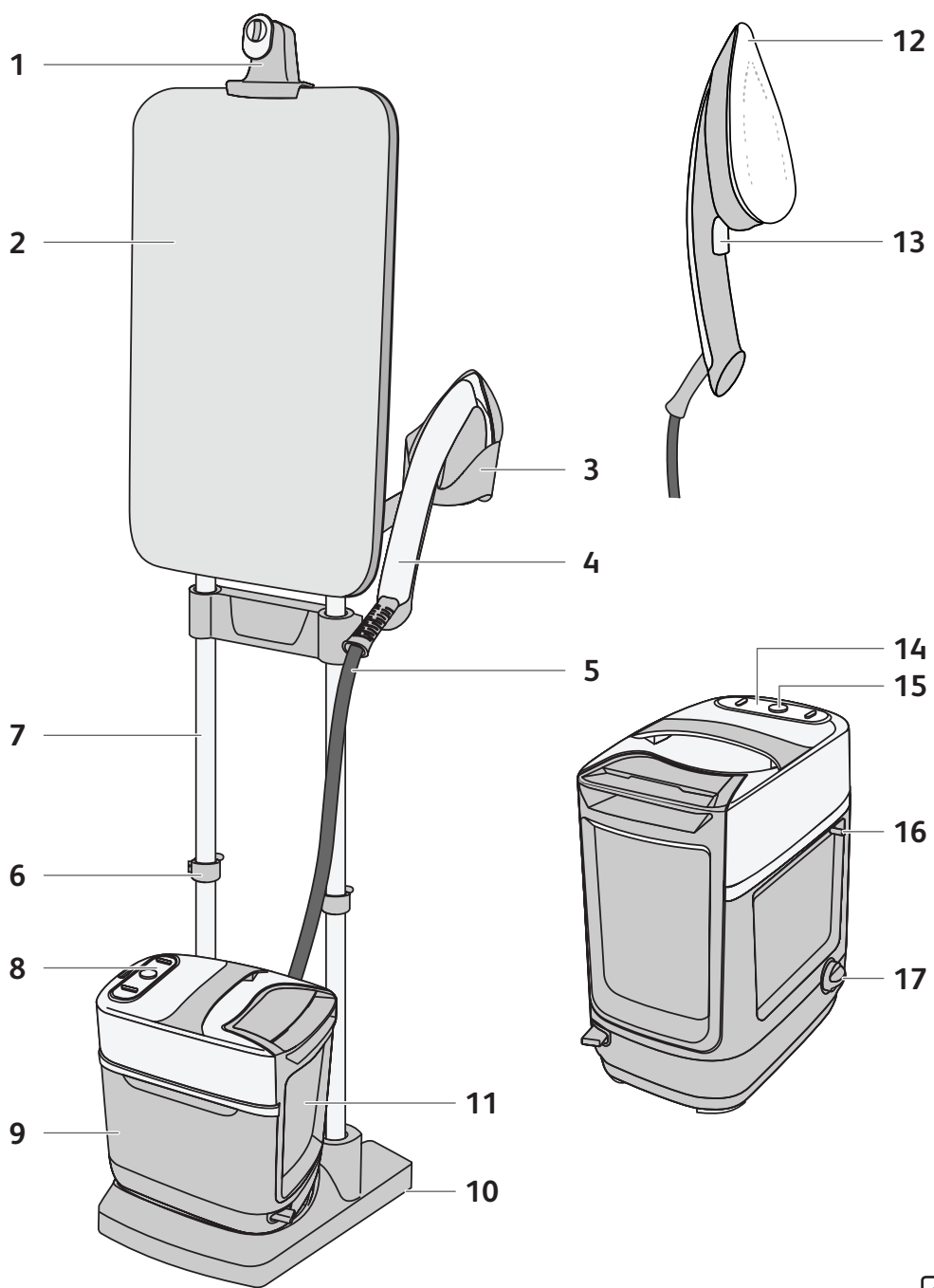

EN

Product presentation

1. Hanger hook
2. Tilting board
3. Iron rest
4. Iron
5. Steam hose
6. Height lockers
7. Collapsible body
8. Control panel
9. Steam unit
10. Wheels
11. Removable water tank
12. Iron soleplate
13. Steam trigger
14. Anti calc light indicator
15. On/Off button
16. Electric cable
17. Anti-calc collector

2. Before first use



On first use, fumes and odour may come from the appliance. They do not affect the use of the appliance and disappear quickly. Small particles may also come from the iron. These are part of the production process and do not affect yourself or your garments. They disappear quickly.

The appliance must be used and placed on a flat, stable, heat-resistant surface. When you place the appliance on its stand, ensure that the surface on which the stand is placed is stable. Never use the appliance if it is turned over.



Never use your appliance board with a classic iron or a steam generator. Only use your appliance iron.

3. First use

Incline the board

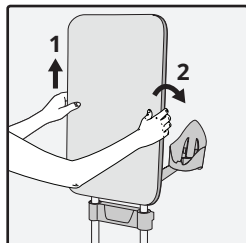

EN Place your hands on each side of the board, raise it vertically, and tilt it back until you find your desired position.

Adjust the board and the iron rest height

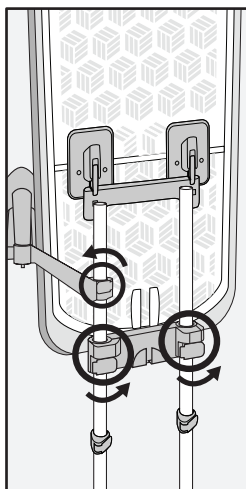

EN When the height of the board or of the iron rest needs to be adjusted, unlock the height adjusters. Raise or lower the board/iron rest until the desired position. Lock the pole lockers.



EN

When adjusting the height of the board make sure you hold on to it as there is a risk that it may fall.

4. Product use

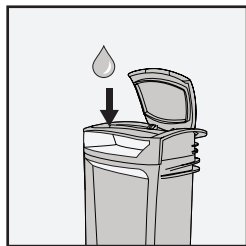

EN

Unplug the appliance.
Remove the water tank. Fill it, and then replace it.

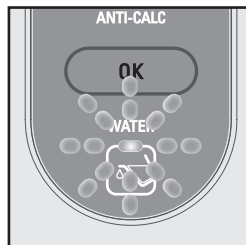

EN

When the water light flashes, please refer to the above instructions, and then, click on the OK button to reboot the light.

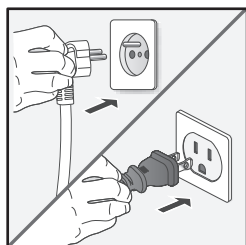

EN

Put the iron on the iron rest. Plug in the appliance and switch it on.
Wait until the light stops flashing.

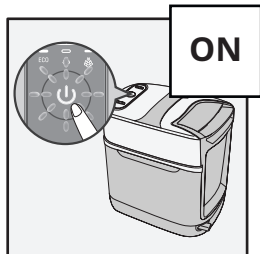

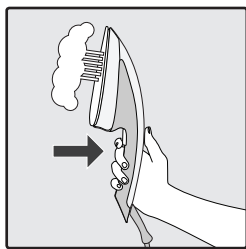

EN

Press the trigger until steam comes out.
Steam pump may produce some noise during this stage, it is completely normal.

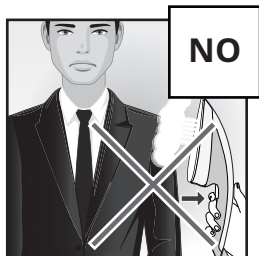

EN

Never iron or steam directly on a garment being worn by someone.

Steam boost

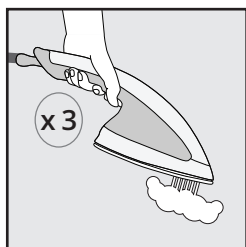

EN

Press the steam trigger three times to activate the steam boost.

Mode selection

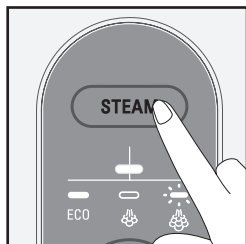

EN To select the desired mode, press the STEAM button.

Auto-off

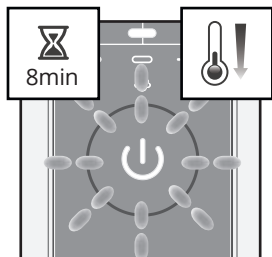

EN After 8 minutes of inactivity, the steam unit will change to stand by mode.

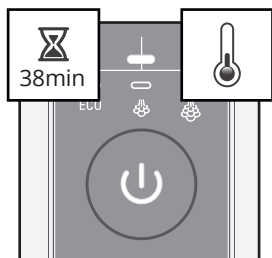

EN After 38 minutes of inactivity, the steam unit will switch off automatically.

5. Accessories

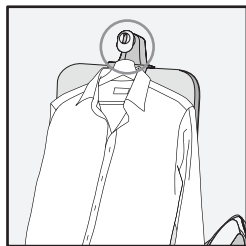

EN

Use the hanger hook to iron a garment placed on a hanger.

Fabric brush

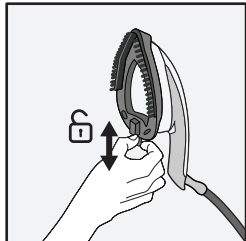

EN

Before you remove or attach the brush, switch off the appliance and allow it to cool down completely for approximately 1 hour. Put the steam brush on the iron soleplate. This accessory helps to open the garment fibres for better steam penetration.

6. Removable base

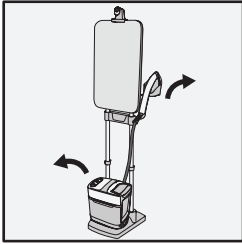

EN

Remove the steam unit off its base.
Unlock this iron rest by pushing on the inside plastic strip. Remove the iron rest with the iron.

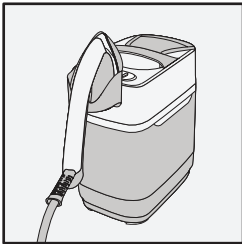
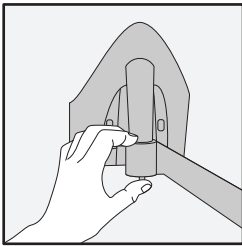

EN

Position the iron and its iron rest on the steam unit.

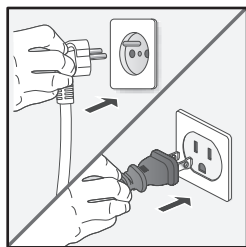

EN

Move around with your appliance. Plug in, switch it on, and wait until it heats up. Always use when steam unit is on the ground, stable.

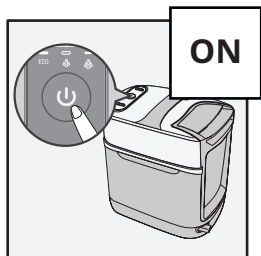

EN

Be careful of heat and steam when using the appliance.

7. Product cleaning

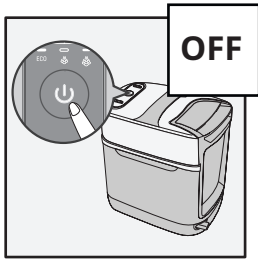

EN

Switch off and unplug the appliance. Wait approximately 1 hour to allow it to cool down completely.

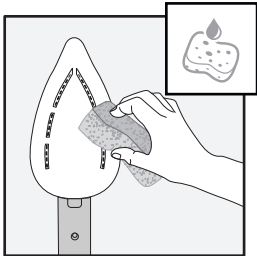
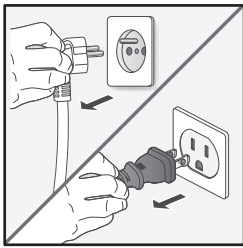

EN

Clean the soleplate with a damp soft cloth or sponge.

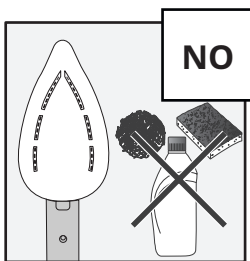

EN

Never use abrasive products or surfaces to clean the soleplate.

8. Product storing

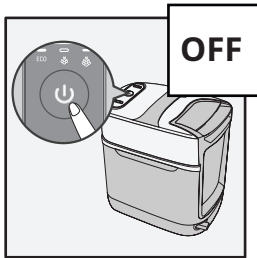

EN

Switch off the appliance. Wait 1 hour to allow it to cool down completely.

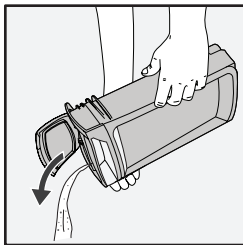
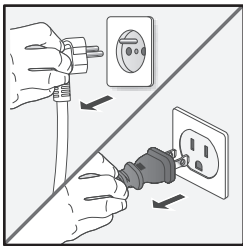

EN

Empty the water tank.

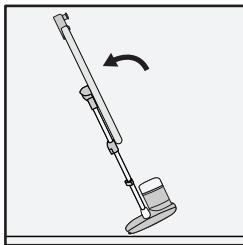

EN

Tip up the board to the vertical position.
Lean the whole appliance backwards in order to move & store it away.

9. Descaling the appliance

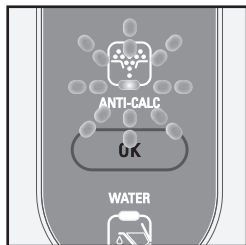

EN When the appliance needs to be descaled, the anti calc light flashes.

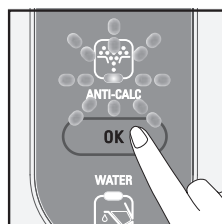
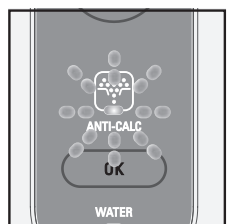
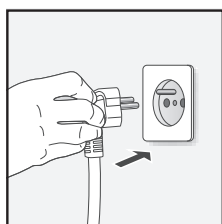
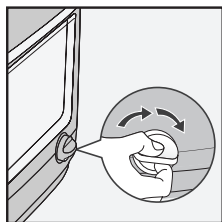
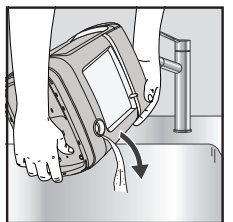
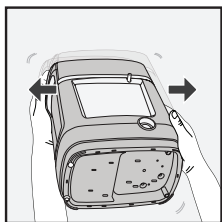
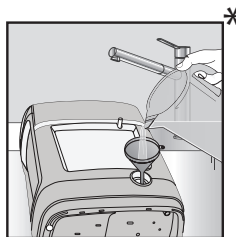
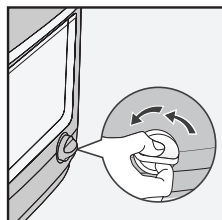
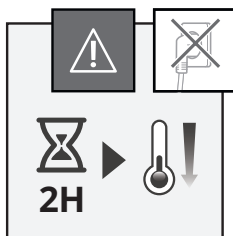
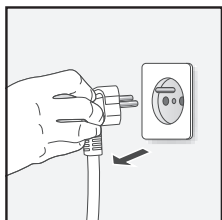
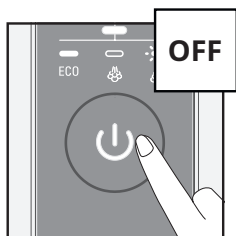

* Not included